

Hanger Portfolio

By



Performance Beyond Expectation

Process Flow

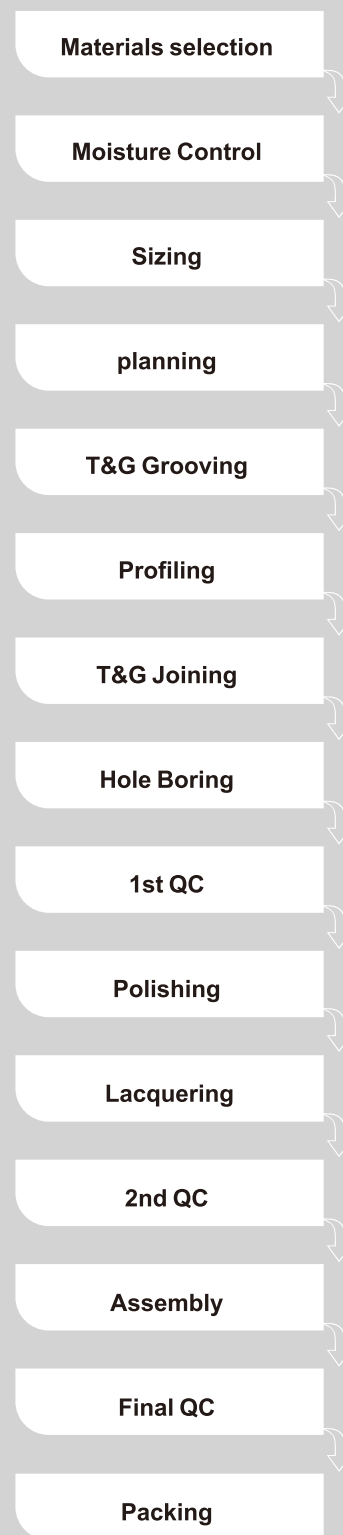

Laboratory Equipment

hygrometer	Measure wood moisture to avoid mould
Photometer	Meaure brightness degree of lacquerin
3Madhesive paper	Test Adhesive of lacquering
Cross-Cut Tester	Test Adhesive of lacquering
Light box	Colors Contrast by Light Box
Salt spray test	Test stability of metal plated to avoid ru
Torque Testers	Test fastness of hook
Pull Testers	Tensile Test for Metal Accessories
Pantone color	Contrasting color between original and m
Calipers	Measure products and accurate to milli





FSC certificate to ensure sustainable development and environmental protection.

Hangers Design

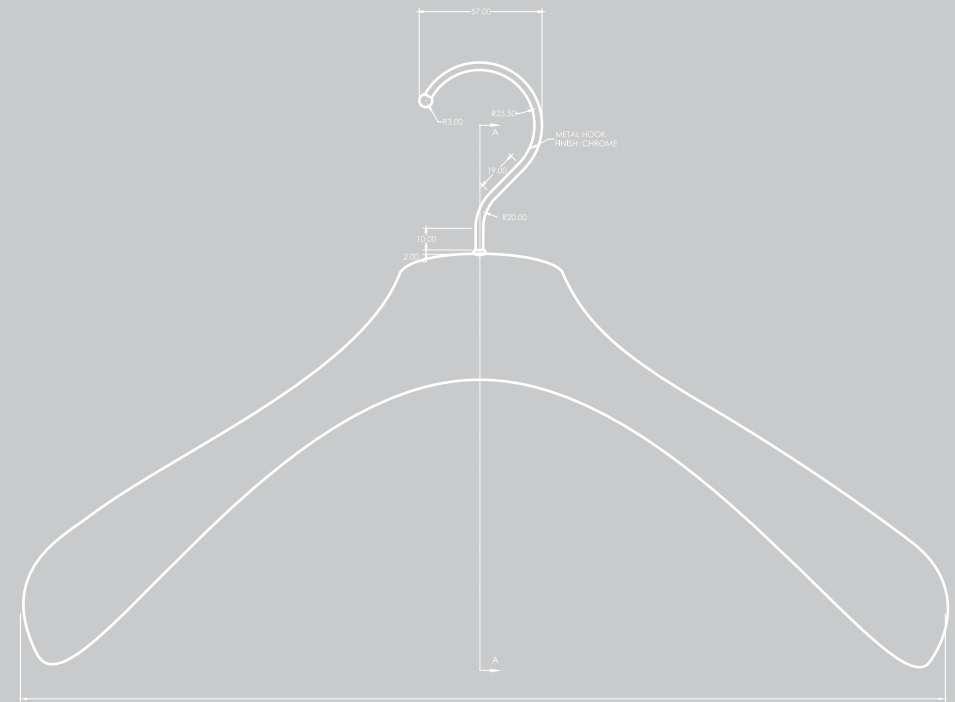

Six professional hanger designers to provide more style options

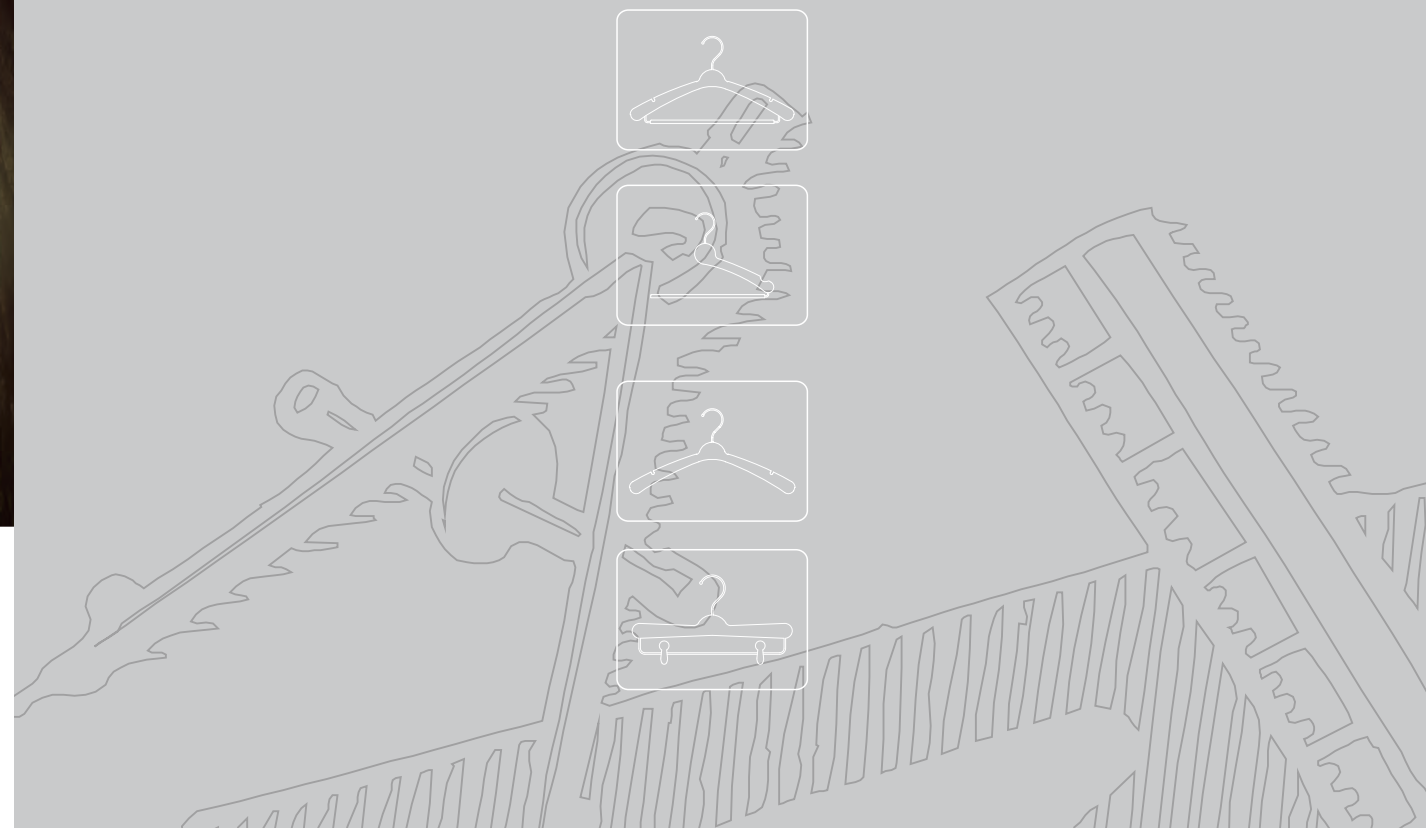



Wooden Hangers

Organize and display your brand garments by the modern deluxe wooden clothes hangers.

Keep her fashionable style, keep her natural shape, and keep your fashion taste.

■ The Values of Displays By Jack

- Customer Service
- Honesty
- Responsibility
- Communication
- Teamwork
- Enthusiasm

Coats&Jackets Hangers

— = Flat shape
 ~ = Curved shape

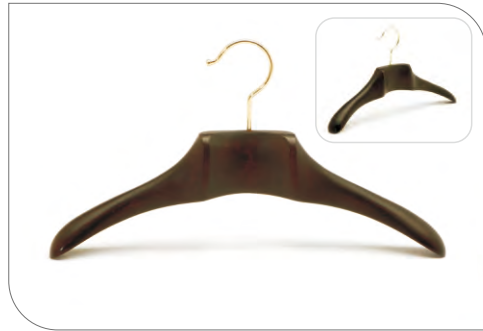

REF SHAPE
 fd2051 ~ 440mm 45mm 230mm 4.0mm 24

Customer Request: _____



REF SHAPE
 fd3036 ~ 460mm 50mm 230mm 5.5mm 24

Customer Request: _____



REF SHAPE
 fd3051 ~ 440mm 40mm 230mm 5.0mm 24

Customer Request: _____



REF SHAPE
 jc043 ~ 430mm 55mm 230mm 4.5mm 24

Customer Request: _____



REF SHAPE
 fd3051 ~ 420mm 40mm 230mm 5.0mm 24

Customer Request: _____



REF SHAPE
 jc043 ~ 440mm 55mm 230mm 4.5mm 24

Customer Request: _____



REF SHAPE
 mc045 ~ 445mm 49mm 230mm 4.0mm 24

Customer Request: _____



REF SHAPE
 mc073 ~ 440mm 60mm 230mm 5.5mm 24

Customer Request: _____



REF SHAPE
 fd2051 ~ 400mm 45mm 230mm 5.5mm 24

Customer Request: _____



REF SHAPE
 fd3036 ~ 440mm 50mm 230mm 5.0mm 24

Customer Request: _____



REF SHAPE
 mc075 ~ 450mm 50mm 230mm 4.0mm 24

Customer Request: _____



REF SHAPE
 mc083 ~ 400mm 30mm 230mm 4.0mm 24

Customer Request: _____

Coats&Jackets Hangers

— =Flat shape
 ~ =Curved shape



REF SHAPE
 mc085 ~ 450mm 50mm 230mm 4.0mm 24

Customer Request: _____



REF SHAPE
 mp066 ~ 450mm 30mm 230mm 4.0mm 24

Customer Request: _____



REF SHAPE
 xh80005 ~ 390mm 35mm 230mm 5.0mm 24

Customer Request: _____



REF SHAPE
 xh80006 ~ 450mm 67mm 230mm 5.0mm 24

Customer Request: _____



REF SHAPE
 mp067 ~ 385mm 40mm 230mm 3.8mm 24

Customer Request: _____



REF SHAPE
 mp068 ~ 450mm 40mm 230mm 3.8mm 24

Customer Request: _____



REF SHAPE
 mp065 ~ 440mm 35mm 230mm 5.0mm 24

Customer Request: _____



REF SHAPE
 mp643 ~ 440mm 67mm 230mm 5.0mm 24

Customer Request: _____



REF SHAPE
 mp073 ~ 400mm 30mm 230mm 3.8mm 24

Customer Request: _____



REF SHAPE
 xh80004 ~ 390mm 35mm 230mm 5.0mm 24

Customer Request: _____

Suits Hangers

— =Flat shape
 ~ =Curved shape



REF SHAPE
 mc092 ~ 400mm 35mm 230mm 3.8mm 24

Customer Request: _____



REF SHAPE
 mc031 — 400mm 67mm 230mm 5.0mm 24

Customer Request: _____



REF SHAPE
 mc048 ~ 450mm 67mm 230mm 5.0mm 24

Customer Request: _____



REF SHAPE
 mc018 — 445mm 12mm 230mm 3.0mm 100

Customer Request: _____



REF SHAPE
 mc022 ~ 435mm 12mm 230mm 3.4mm 100

Customer Request: _____



REF SHAPE
 xh0800049 — 450mm 60mm 230mm 5.0mm 24

Customer Request: _____



REF SHAPE
 mc019 — 445mm 12mm 230mm 3.0mm 100

Customer Request: _____



REF SHAPE
 mc014 — 445mm 12mm 230mm 3.0mm 100

Customer Request: _____



REF SHAPE
 mc044 — 400mm 35mm 230mm 5.0mm 24

Customer Request: _____



REF SHAPE
 mc023 ~ 435mm 12mm 230mm 3.4mm 100

Customer Request: _____



REF SHAPE
 mc010-1 — 445mm 12mm 230mm 3.0mm 100

Customer Request: _____



REF SHAPE
 mc028 — 450mm 12mm 230mm 3.0mm 24

Customer Request: _____

Suits Hangers

— = Flat shape
 ~ = Curved shape



REF SHAPE
 mc033 — 445mm 13mm 230mm 3.0mm 100

Customer Request: _____



REF SHAPE
 mc041 — 450mm 60mm 230mm 4.8mm 24

Customer Request: _____



REF SHAPE
 mp611 — 420mm 10mm 230mm 3.2mm 100

Customer Request: _____



REF SHAPE
 mp639 — 445mm 12mm 230mm 3.0mm 100

Customer Request: _____



REF SHAPE
 mc016 — 445mm 12mm 230mm 3.0mm 100

Customer Request: _____



REF SHAPE
 mc050 — 450mm 12mm 230mm 3.0mm 100

Customer Request: _____



REF SHAPE
 mc011 — 445mm 12mm 230mm 3.0mm 100

Customer Request: _____



REF SHAPE
 mp637 — 445mm 12mm 230mm 3.0mm 100

Customer Request: _____



REF SHAPE
 mp612 — 307mm 10mm 230mm 3.2mm 100

Customer Request: _____



REF SHAPE
 mp632 — 445mm 12mm 230mm 3.0mm 100

Customer Request: _____



REF SHAPE
 mc031 — 445mm 12mm 230mm 3.0mm 100

Customer Request: _____

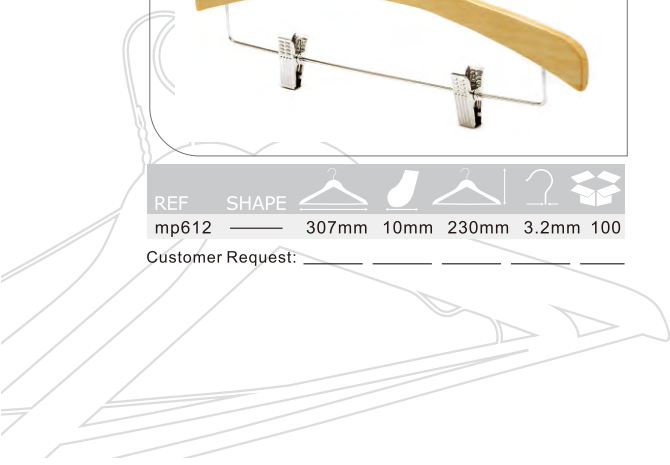

Top Shirts Hangers

— =Flat shape
 ~ =Curved shape



REF. SHAPE
 mt0135 — 360mm 14mm 230mm 3.4mm 100
 Customer Request: _____



REF. SHAPE
 ml631 — 360mm 12mm 230mm 3.4mm 100
 Customer Request: _____



REF. SHAPE
 mp629 — 390mm 35mm 230mm 5.0mm 24
 Customer Request: _____



REF. SHAPE
 mp610-1 — 420mm 10mm 230mm 3.0mm 100
 Customer Request: _____



REF. SHAPE
 mc025-b — 240mm 10mm 230mm 3.0mm 100
 Customer Request: _____



REF. SHAPE
 mp610 — 420mm 10mm 150mm 3.4mm 100
 Customer Request: _____



REF. SHAPE
 mp615-1 — 440mm 10mm 230mm 3.4mm 100
 Customer Request: _____



REF. SHAPE
 mp616 — 420mm 10mm 230mm 3.0mm 100
 Customer Request: _____



REF. SHAPE
 mc034 — 400mm 30mm 230mm 3.8mm 24
 Customer Request: _____



REF. SHAPE
 mp613 — 420mm 10mm 230mm 3.0mm 100
 Customer Request: _____



REF. SHAPE
 mc089 — 400mm 20mm 230mm 3.0mm 50
 Customer Request: _____



REF. SHAPE
 mc088 — 400mm 20mm 230mm 3.4mm 50
 Customer Request: _____

Top Shirts Hangers



REF SHAPE    ? 
mc034-3 — 400mm 12mm 230mm 3.4mm 100

Customer Request: _____



REF SHAPE    ? 
mc034-2 — 400mm 12mm 230mm 3.4mm 100

Customer Request: _____



REF SHAPE    ? 
mp629 — 440mm 35mm 230mm 5.0mm 24

Customer Request: _____



REF SHAPE    ? 
mp610-1 — 420mm 10mm 230mm 3.0mm 100

Customer Request: _____

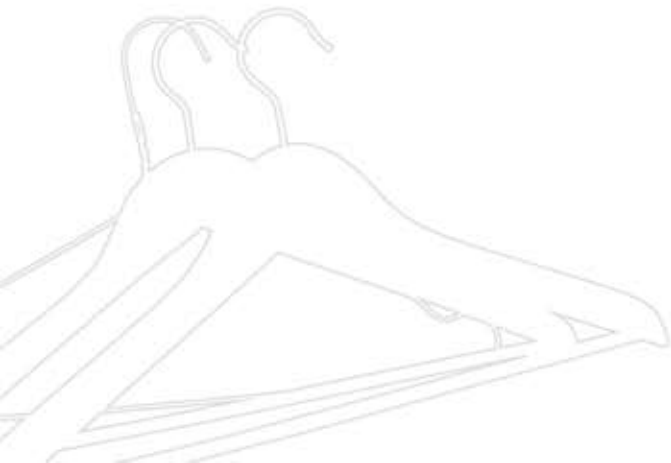

Pants Hangers

— = Flat shape
 ~ = Curved shape



REF SHAPE
 mk10 — 360mm 14mm 150mm 3.4mm 100

Customer Request: _____



REF SHAPE
 mk11 — 360mm 12mm 150mm 3.4mm 100

Customer Request: _____

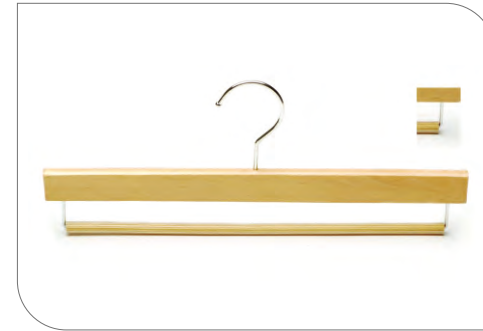

REF SHAPE
 mk25 — 360mm 12mm 180mm 3.4mm 100

Customer Request: _____



REF SHAPE
 mk17 — 250mm 10mm 200mm 3.0mm 100

Customer Request: _____



REF SHAPE
 mk12 — 240mm 10mm 180mm 3.0mm 100

Customer Request: _____



REF SHAPE
 mk14 — 360mm 14mm 150mm 3.4mm 100

Customer Request: _____



REF SHAPE
 mk32 — 360mm 12mm 180mm 3.4mm 100

Customer Request: _____



REF SHAPE
 mk33 — 360mm 12mm 180mm 3.4mm 100

Customer Request: _____



REF SHAPE
 mk15 — 350mm 13mm 150mm 3.0mm 100

Customer Request: _____



REF SHAPE
 mk16 — 355mm 14mm 150mm 3.4mm 100

Customer Request: _____



REF SHAPE
 mk34 — 360mm 12mm 200mm 3.0mm 100

Customer Request: _____



REF SHAPE
 mk31 — 360mm 12mm 200mm 3.4mm 100

Customer Request: _____

Pants Hangers

— = Flat shape
 ~ = Curved shape



REF SHAPE
 mp640 — 360mm 12mm 180mm 4.0mm 100

Customer Request: _____

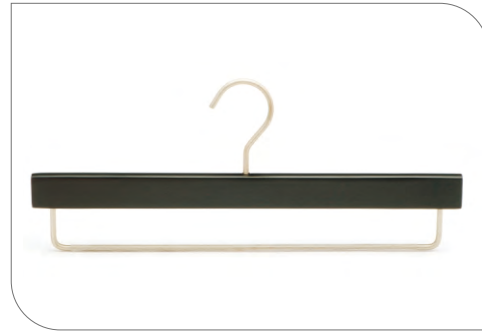

REF SHAPE
 mp070 — 360mm 12mm 180mm 4.0mm 100

Customer Request: _____



REF SHAPE
 mk28 — 360mm 12mm 200mm 3.0mm 100

Customer Request: _____



REF SHAPE
 mk28-1 — 360mm 14mm 200mm 3.4mm 100

Customer Request: _____

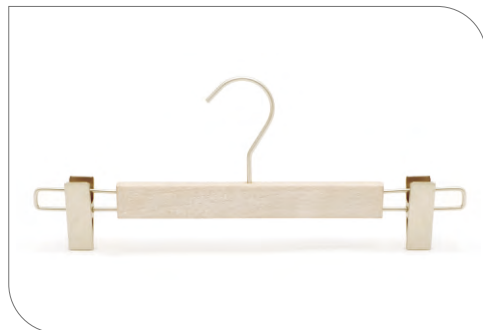

REF SHAPE
 mp065 — 365mm 12mm 150mm 4.0mm 100

Customer Request: _____

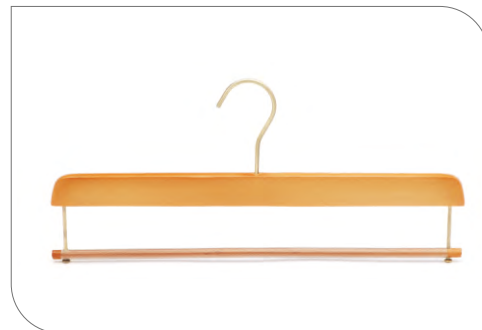

REF SHAPE
 mp643 — 360mm 12mm 180mm 4.0mm 100

Customer Request: _____



REF SHAPE
 mk31 — 355mm 12mm 200mm 3.0mm 100

Customer Request: _____

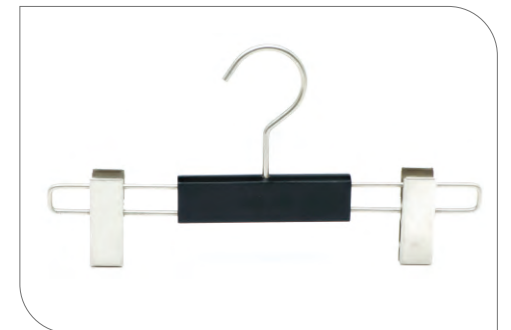

REF SHAPE
 mk20 — 200mm 12mm 180mm 4.0mm 100

Customer Request: _____



REF SHAPE
 mk27 — 360mm 14mm 150mm 3.4mm 100

Customer Request: _____



REF SHAPE
 mk29 — 360mm 12mm 200mm 3.4mm 100

Customer Request: _____



REF SHAPE
 mk30 — 230mm 12mm 150mm 3.2mm 100

Customer Request: _____

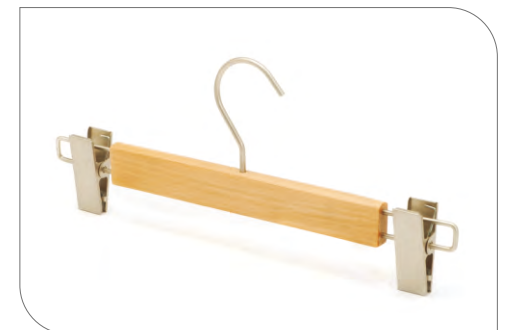

REF SHAPE
 mk29 — 230mm 12mm 150mm 3.6mm 100

Customer Request: _____

Kids Hangers

— = Flat shape
⤿ = Curved shape



REF SHAPE 
mp02c — 255mm 11mm 230mm 3.0mm 100

Customer Request: _____



REF SHAPE 
mp01-1 — 250mm 10mm 230mm 3.0mm 100

Customer Request: _____



REF SHAPE 
mp613-2 — 280mm 10mm 230mm 3.0mm 100

Customer Request: _____



REF SHAPE 
mp620-1 — 280mm 10mm 230mm 3.0mm 100

Customer Request: _____



REF SHAPE 
mp01-2c — 255mm 11mm 230mm 3.0mm 100

Customer Request: _____



REF SHAPE 
mp01-3 — 250mm 10mm 230mm 3.0mm 100

Customer Request: _____



REF SHAPE 
mp620-3 — 300mm 12mm 230mm 3.0mm 100

Customer Request: _____



REF SHAPE 
mp620-2 — 300mm 12mm 230mm 3.0mm 100

Customer Request: _____



REF SHAPE 
mp03 — 240mm 10mm 230mm 3.0mm 100

Customer Request: _____



REF SHAPE 
mp612b — 300mm 10mm 230mm 3.0mm 100

Customer Request: _____



REF SHAPE 
mp620 — 300mm 12mm 230mm 3.0mm 100

Customer Request: _____



REF SHAPE 
mp621-1 — 360mm 14mm 230mm 3.4mm 100

Customer Request: _____

Kids Hangers

— = Flat shape
 ~ = Curved shape



REF SHAPE
 mp621-2 — 300mm 12mm 230mm 3.8mm 24

Customer Request: _____



REF SHAPE
 mp621 — 300mm 12mm 230mm 5.0mm 24

Customer Request: _____



REF SHAPE
 mp645 — 350mm 35mm 230mm 3.0mm 24

Customer Request: _____



REF SHAPE
 mp646 ~ 300mm 30mm 230mm 3.0mm 24

Customer Request: _____

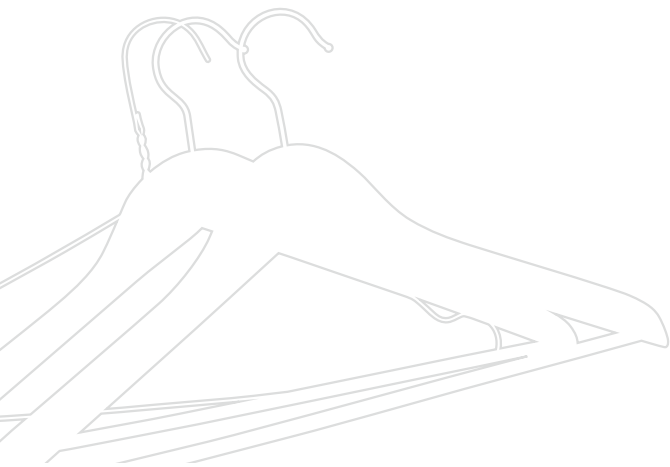



Laminated Hangers

Elegant style, relaxed touch, grace your garment

Providing best-in-class quality, design, services, and total business solution and maximize value to our customers, share holders and employees. Strive to be the world leaders in the clothes hanger industry.

Laminated Hangers

— = Flat shape
 ~ = Curved shape



REF SHAPE
 mp627 ——— 370mm 11mm 230mm 3.4mm 100

Customer Request: _____



REF SHAPE
 mp628 ——— 420mm 12mm 230mm 3.4mm 100

Customer Request: _____



REF SHAPE
 ml021 ——— 440mm 30mm 230mm 3.4mm 100

Customer Request: _____



REF SHAPE
 ml022 ——— 440mm 50mm 230mm 3.4mm 100

Customer Request: _____



REF SHAPE
 ml009 ——— 420mm 11mm 230mm 3.4mm 100

Customer Request: _____



REF SHAPE
 ml010 ——— 410mm 12mm 230mm 3.4mm 100

Customer Request: _____



REF SHAPE
 ml023 ——— 440mm 30mm 230mm 3.4mm 100

Customer Request: _____



REF SHAPE
 ml024 ——— 440mm 50mm 230mm 3.4mm 100

Customer Request: _____



REF SHAPE
 ml011 ——— 420mm 12mm 230mm 3.4mm 100

Customer Request: _____



REF SHAPE
 ml020 ——— 440mm 40mm 230mm 3.4mm 100

Customer Request: _____



REF SHAPE
 mp624 ——— 420mm 11mm 230mm 3.4mm 100

Customer Request: _____









REF SHAPE
 mp625 ——— 420mm 12mm 230mm 3.4mm 100

Customer Request: _____







Laminated Hangers

— = Flat shape
 ~ = Curved shape



REF SHAPE      
 mk35 ——— 280mm 11mm 230mm 3.4mm 100
 Customer Request: _____



REF SHAPE      
 mk36 ——— 300mm 11mm 230mm 3.4mm 100
 Customer Request: _____

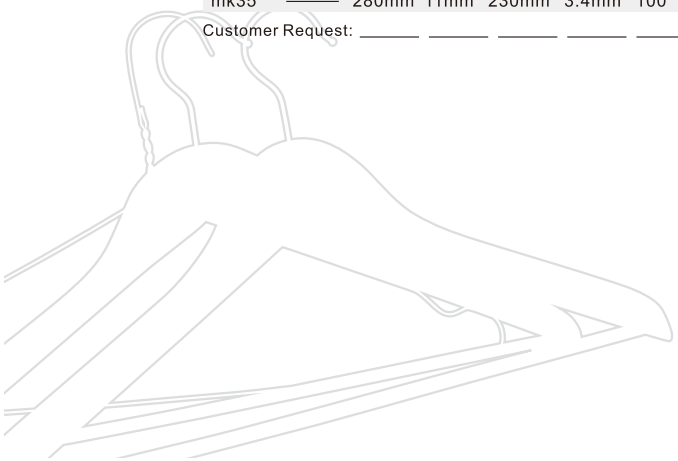

Bamboo Hangers

— =Flat shape
 ~ =Curved shape



REF SHAPE
 mb02 — 240mm 10mm 240mm 3.0mm 100

Customer Request: _____



REF SHAPE
 mb05-1 — 445mm 12mm 240mm 3.0mm 100

Customer Request: _____



REF SHAPE
 mb05-2 — 445mm 12mm 245mm 3.0mm 100

Customer Request: _____



REF SHAPE
 mb05 — 445mm 12mm 245mm 3.0mm 100

Customer Request: _____

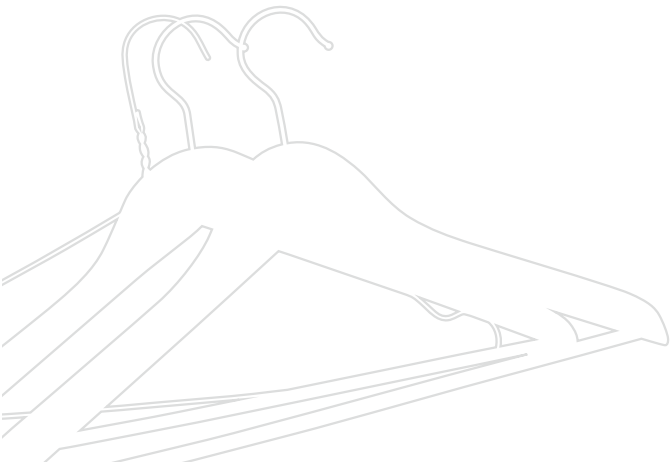

REF
 mb09 440mm 11mm 280mm 3.4mm



REF
 mb11 300mm 19mm 280mm 3.4mm



REF
 mb12 420mm 12mm 280mm 3.4mm



REF
 mb13-1 440mm 12mm 280mm 3.4mm

Tie/Belt Hangers

— = Flat shape
~ = Curved shape



REF SHAPE      
mp03 — 230mm 11mm 280mm 3.0mm 90

Customer Request: _____



REF SHAPE      
mp04 — 110mm 40mm 190mm 3.4mm 40

Customer Request: _____



REF SHAPE      
mp05 — 430mm 20mm 190mm 3.4mm 50

Customer Request: _____



REF SHAPE      
mp641 — 420mm 50mm 225mm 5.0mm 50

Customer Request: _____



REF     
mp07 415mm 50mm 230mm 5.0mm



REF     
mp66 300mm 20mm 300mm 3.4mm

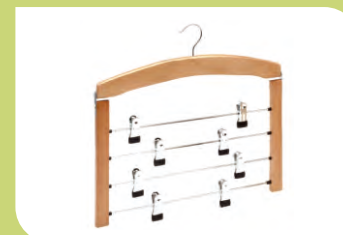

REF     
mp08-2 410mm 15mm 300mm 3.4mm



REF     
mp618 400mm 50mm 160mm 5.0mm

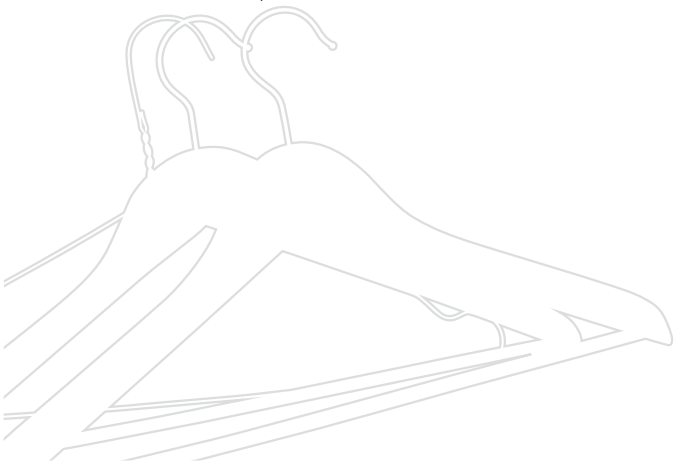



Metal Hangers

We offer Metal Hangers normally made of wire. The thickness is above Dia.2.8mm. The surface finishing can be chrome, nickle, golden, powder, etc. They are stainless and can hang wet clothes. PVC coating and Foam tube are widely used to anti-slip.

With Durable and Space Saving features, Metal Hanger is another good choice on beauty and function.

Foam Metal Hangers

— = Flat shape
 ~ = Curved shape

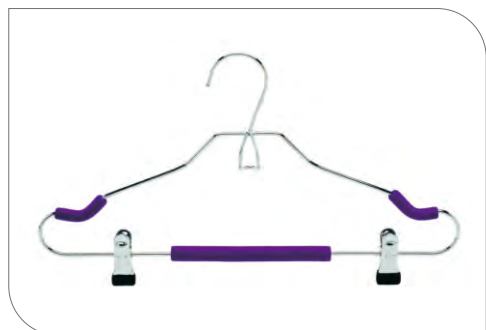

REF SHAPE
 e8001 — 425mm 50mm 240mm 5.0mm 30

Customer Request: _____

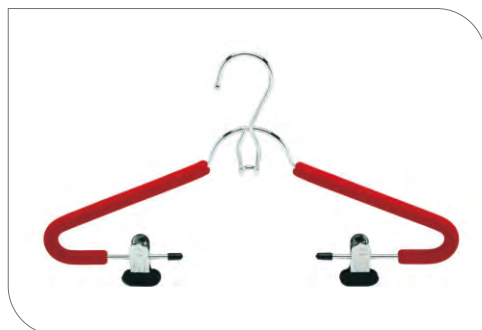

REF SHAPE
 e8002 — 405mm 50mm 240mm 5.0mm 30

Customer Request: _____



REF SHAPE
 tp801 — 340mm 50mm 160mm 5.0mm 50

Customer Request: _____



REF SHAPE
 tp804-1 — 415mm 50mm 230mm 5.0mm 30

Customer Request: _____



REF
 tp804 415mm 50mm 230mm 5.0mm



REF
 tp805 420mm 50mm 225mm 5.0mm



REF
 tp809 405mm 50mm 250mm 5.0mm



REF
 tp811 400mm 50mm 160mm 5.0mm



REF
 tp810 405mm 50mm 240mm 5.0mm



REF
 tp815 405mm 50mm 240mm 5.0mm

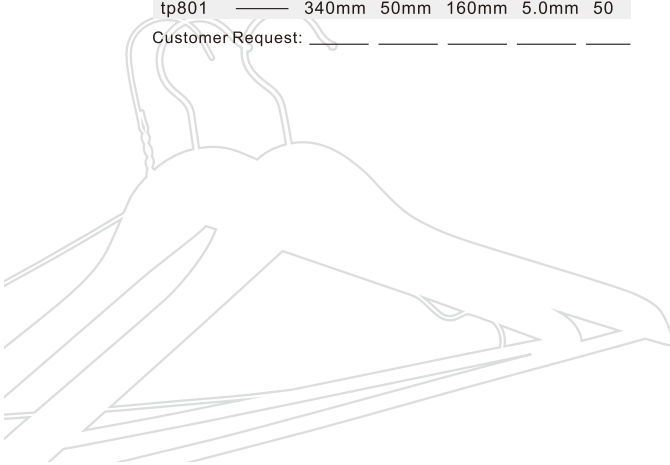

Chrome Metal Hangers

— = Flat shape
 ~ = Curved shape



REF	SHAPE									
tb101	—	300mm	40mm	140mm	4.0mm	80				

Customer Request: _____



REF	SHAPE									
tb102	—	360mm	33.5mm	140mm	3.35mm	60				

Customer Request: _____

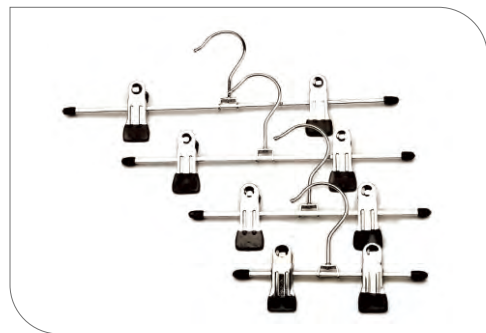

REF	SHAPE									
tb103	—	500mm	30mm	140mm	3.0mm	100				

Customer Request: _____



REF	SHAPE									
tb104	—	385mm	33.5mm	230mm	3.35mm	50				

Customer Request: _____

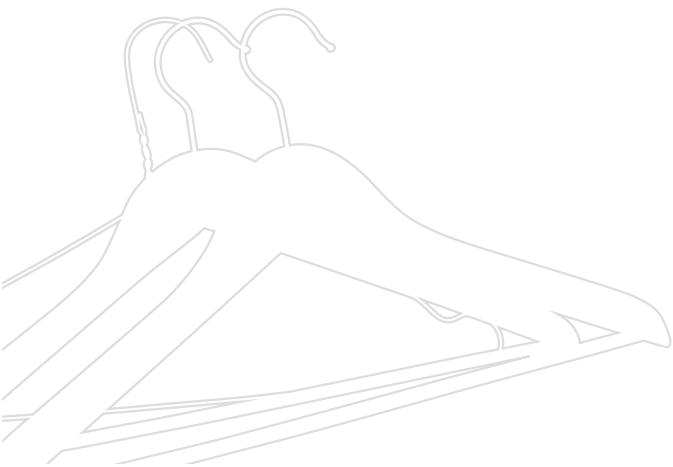

REF					
tb106	330mm	45mm	230mm	4.5mm	



REF					
tb107	305mm	40mm	175mm	4.0mm	



REF					
tb108	380mm	50mm	335mm	5.0mm	



REF					
tb109	458mm	33.5mm	345mm	3.35mm	



REF					
tb110	320mm	38mm	480mm	3.8mm	

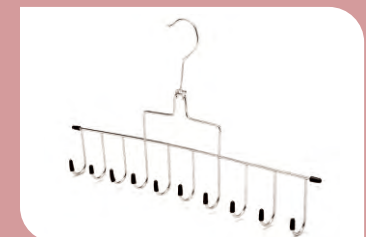

REF					
tc309	460mm	33.5mm	260mm	3.35mm	

Chrome Metal Hangers

— = Flat shape
 ~ = Curved shape



REF	SHAPE							
tb116	—	305mm	32mm	420mm	3.2mm	50		

Customer Request: _____



REF	SHAPE							
tb115	—	300mm	35mm	120mm	3.5mm	100		

Customer Request: _____



REF	SHAPE							
tb126	—	45mm	33.5mm	108mm	3.35mm	250		

Customer Request: _____



REF	SHAPE							
td326	—	430mm	40mm	200mm	4.0mm	50		

Customer Request: _____



REF				
td327	420mm	50mm	190mm	4.0mm



REF				
td328	380mm	50mm	180mm	4.8mm



REF				
td331	385mm	40mm	210mm	4.0mm



REF				
td334	405mm	50mm	250mm	5.0mm



REF				
td336	410mm	45mm	230mm	4.5mm



REF				
tb114	335mm	40mm	335mm	5.0mm

Vinyl Coating Metal Hangers

— = Flat shape
 ⤿ = Curved shape



REF SHAPE
 tf002 — 335mm 40mm 335mm 5.0mm 30

Customer Request: _____



REF SHAPE
 tf001 — 380mm 38mm 205mm 3.8mm 60

Customer Request: _____



REF SHAPE
 ts214 — 400mm 40mm 210mm 4.0mm 60

Customer Request: _____

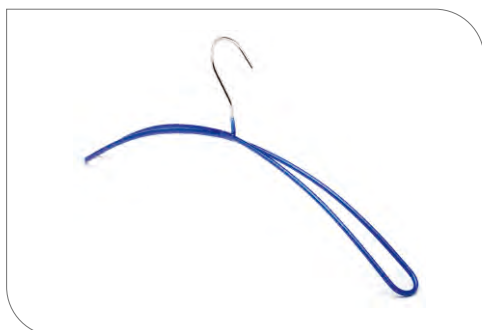

REF SHAPE
 tf028 — 430mm 40mm 200mm 4.0mm 50

Customer Request: _____



REF
 tf029 420mm 50mm 190mm 4.0mm



REF
 ts201 380mm 50mm 180mm 4.8mm



REF
 ts203 385mm 40mm 210mm 4.0mm



REF
 ts204 405mm 50mm 250mm 5.0mm



REF
 ts205 410mm 45mm 230mm 4.5mm



REF
 ts208 430mm 40mm 190mm 4.0mm

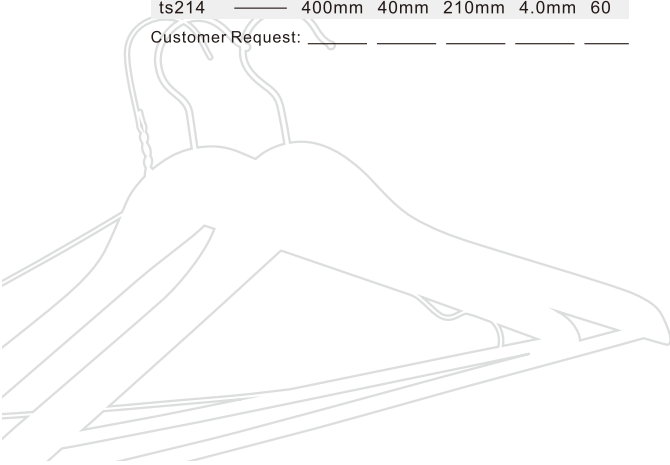

Vinyl Coating Metal Hangers

— = Flat shape
 ⤿ = Curved shape



REF	SHAPE								
ts258	—	335mm	40mm	335mm	5.0mm	30			

Customer Request: _____



REF	SHAPE								
ts213	—	380mm	38mm	205mm	3.8mm	60			

Customer Request: _____



REF	SHAPE								
ts261	—	400mm	40mm	210mm	4.0mm	60			

Customer Request: _____



REF	SHAPE								
ts262	—	430mm	40mm	200mm	4.0mm	50			

Customer Request: _____



REF				
ts265	380mm	50mm	180mm	4.8mm



REF				
ts218	380mm	50mm	180mm	4.8mm



REF				
ts219	385mm	40mm	210mm	4.0mm



REF				
ts220	405mm	50mm	250mm	5.0mm



REF				
td223	410mm	45mm	230mm	4.5mm



REF				
ts240	430mm	40mm	190mm	4.0mm

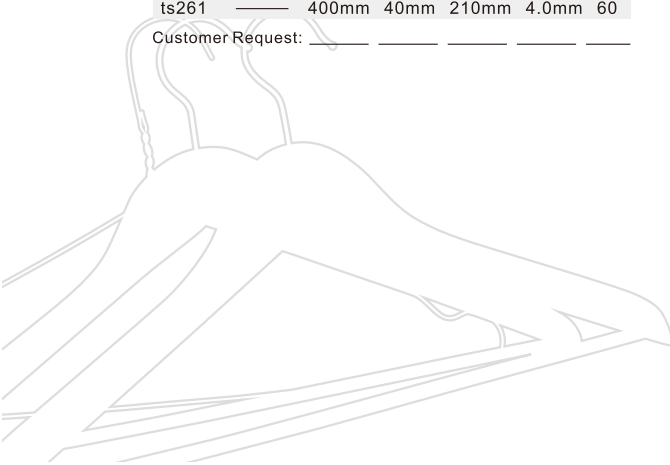

Vinyl Coating Metal Hangers



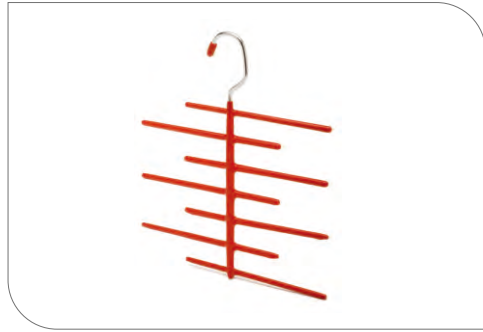

— = Flat shape
~ = Curved shape



REF SHAPE     
ts241 — 335mm 40mm 335mm 5.0mm 30



Customer Request: _____



REF SHAPE     
ts260 — 380mm 38mm 205mm 3.8mm 60





Customer Request: _____



REF SHAPE     
ts244 — 400mm 40mm 210mm 4.0mm 60

Customer Request: _____



REF SHAPE     
ts246 — 430mm 40mm 200mm 4.0mm 50

Customer Request: _____



REF    
ts248 420mm 50mm 190mm 4.0mm



REF    
ts250 380mm 50mm 180mm 4.8mm



REF    
ts252 385mm 40mm 210mm 4.0mm



REF    
ts253 405mm 50mm 250mm 5.0mm



REF    
ts254 410mm 45mm 230mm 4.5mm



REF    
ts256 430mm 40mm 190mm 4.0mm

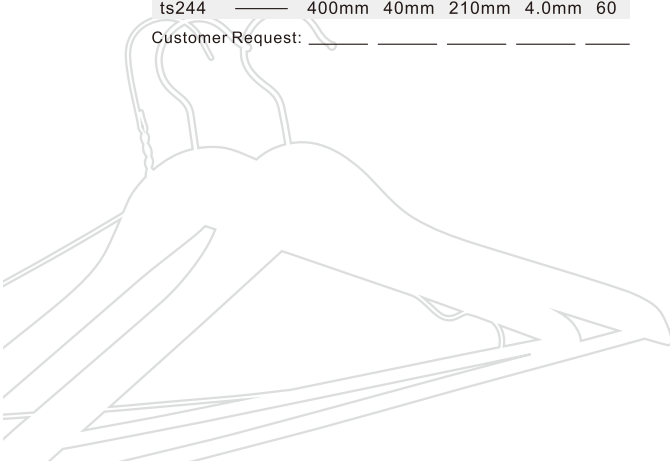

Satin & Velvet Hangers

— = Flat shape
 ~ = Curved shape



REF SHAPE
 mr007a — 380mm 31mm 150mm 3.0mm 100

Customer Request: _____



REF SHAPE
 mr009 — 380mm 31mm 150mm 3.0mm 100

Customer Request: _____



REF SHAPE
 mr015 — 380mm 31mm 150mm 3.0mm 100

Customer Request: _____



REF SHAPE
 mr012 — 380mm 31mm 150mm 3.0mm 100

Customer Request: _____



REF
 mr017 450mm 40mm 200mm 3.2mm



REF
 mr016 420mm 7mm 205mm 3.0mm



REF
 mr013 400mm 7mm 380mm 3.0mm



REF
 mr006 445mm 45mm 250mm 3.4mm



REF
 mr002 355mm 12mm 250mm 3.2mm



REF
 mr001 320mm 12mm 130mm 3.2mm

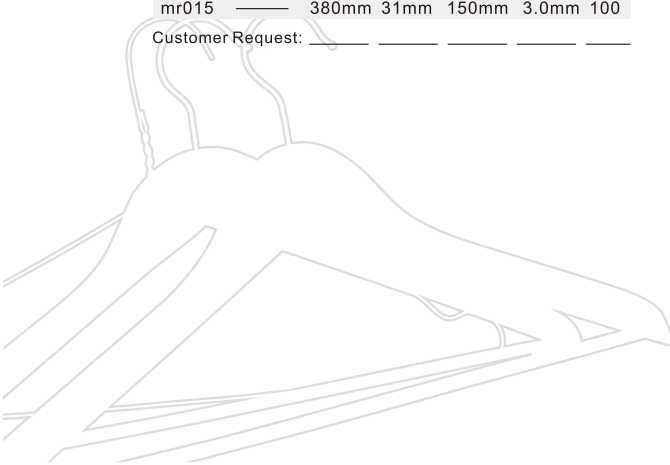

Hanger Accessories

Clips&Hooks



Black Powder Hook



Bright Nickle Hook



Matt Golden Hook



Light Golden Nickle Hook



Chrome Hook



Brass Hook



Bright Nickle Hook



Theftproof Hook



Theftproof Hook



gold open hook with end hook



open hook with bent end



open hook with loop end



gun metal fiat end hook



chrome ball end hook



nickel ball end hook



black ball end hook



chrome fiat end hook



is the most secure means of holding garments with shoulder straps. The two tapered fingers at the top of the notch are designed to provide maximum strength and prevent the straps from easily slipping out of the notch.



transparent plastic clip



chrome clip



chrome flat clip



chrome clip with PVC coating



nickel flat clip



black plastic clip

is used only for garments with thin "spaghetti" style shoulder straps. All notches are smoothly finished to provide a snag free surface.



Round Velvet wooden bar



Wire coil with wooden bar



Round wooden bar with nonslip vinyl tube



Square wooden bar with nonslip vinyl strip

is designed to hold garments with extra wide shoulder straps. This notch will also hold standard and narrow width straps.



Matt Black Coating



Shiny Black Coating



Gold Coating



Matt Nickle Coating



Brass Coating

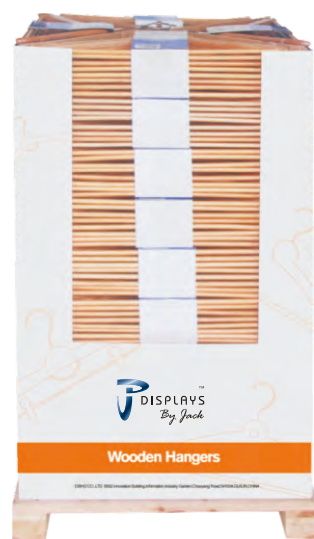

Wooden Hangers
Wooden Hangers With the skirt notches



Solid Wood Top Hangers



● Elm Wood



● Beech Wood



● Lotus Wood



● Birch Wood



● Native Wood



● Rubber Wood



● Maple Wood



● Ashtree Wood

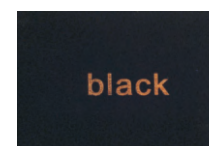

Black



Blue

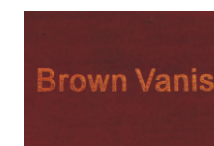

Brown Vanish

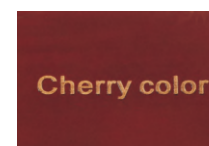

Cherry color



Green



Grey

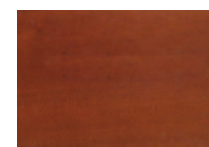

Mahogany

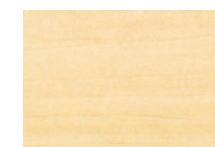

Natural color

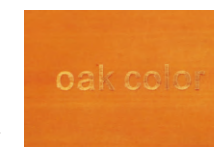

Oak color

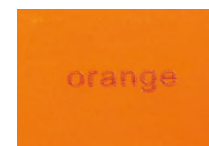

Orange



Red

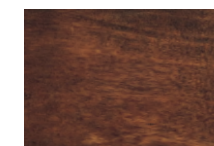

Transparent black



Walnut color

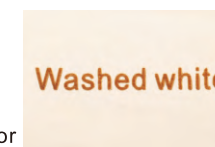

Washed white



Yellow

Distribution of customers

Displays By Jack customers mainly state diagram



North America

- Mexico
- Canada
- Unite State

South America

- Argentina
- Brazil

Oceania

- Australia

East Europe

- Ukraine
- Russia
- Poland

Western Europe

- Germany
- Italy
- UK
- France
- Spain
- Netherland
- Denmark
- Portugal
- Belgium
- Switzerland
- Sweden-H&M

Asia

- India
- Japan
- South Korea
- Singapore
- Malaysia
- Hong Kong
- Shanghai
- Shenzhen

Africa

- Durban

Logo

All the LOGO in this page are just for a product study

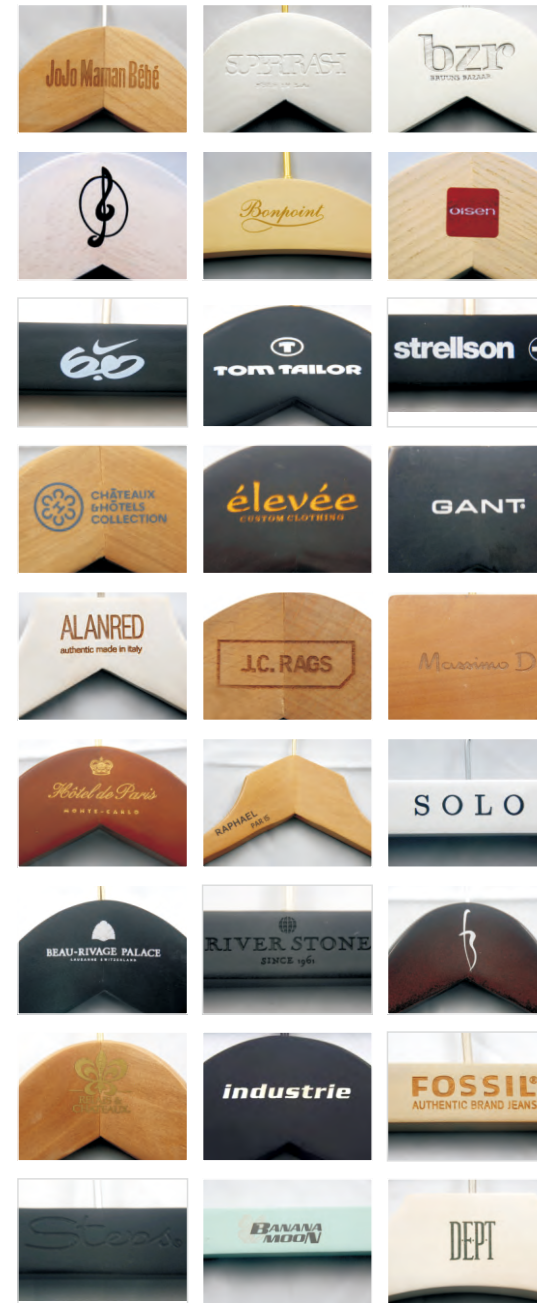

Technics:
Metal logo plates



Technics:
Metal logo plates



Technics:
Laser engraving



Technics:
Laser engraving



Technics:
Scald logo



Technics:
Silver coating printed



Inspiring Displays

Custom items will be priced according to quantity, material, finish, packaging and shipping destination. Please contact our factory representatives for quantity pricing.



● **Headquarter & Warehouse**

12930-12950 Alondra Boulevard,
Cerritos, CA 90703, U.S.A.
office: (562) 802-0888
toll free: (855) DBJ-DISP
fax: (562) 802-1111
salespf@displaysbyjack.com
www.displaysbyjack.com

● **Canada Western Territory
Mexico Western Territory
USA West Coast Region**

contact: Mike Ijin
office: (714) 882-0907
mikeiljin@displaysbyjack.com

● **USA Midwest Region**

contact: Chris Weaver
office: (714) 357-5705
chrisweaver@displaysbyjack.com

● **Mt Prospect, Illinois Office**

● **Georgia, Atlanta Office**

● **Canada Eastern Territory
USA East Coast Region**

contact: John Pasciucco
office: (203) 912-8347
johnp@displaysbyjack.com

contact: Gerald Denenberg
office: (954) 806-8783
gdenenberg@displaysbyjack.com