



Inspiring Displays

PREFACE

This catalog is designed to help you easily locate the products which you are interested in.

HOW TO USE THIS CATALOG

This catalog is paged with three combinations of alphabets and digits as following:

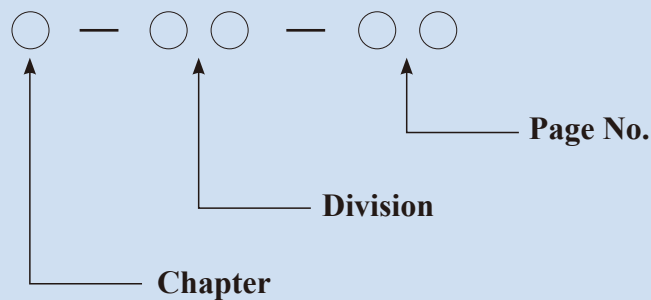

It begins with one alphabet which represents 26 chapters from A-Z and with illustrated icons for easy identification, see front table of contents.

Then this alphabet followed by two digits which represents various divisions, see each chapter's table of content.

And then again followed by two digits which represents a series of page numbers.

For example, if you are looking for our #MQ74C-4 arm garment rack, you should start as following procedure:

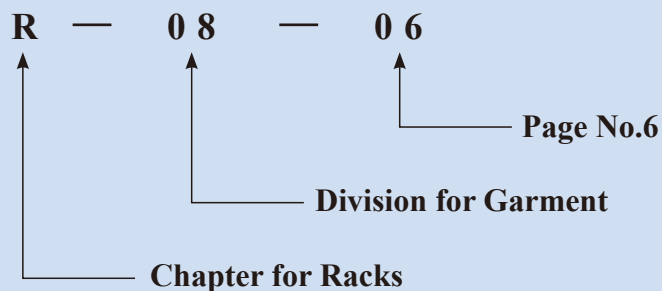

TABLE OF CONTENTS

























ICON	CHAPTER	CONTENTS
	A	ACRYLIC
	B	BAGS & COVERS
	C	CROSSBAR
	D	CUBBIES
	E	DISPLAY STANDS & TOPS
	F	DISPLAYERS
	G	GONDOLAS & DIVIDERS
	H	GRIDWALL
	I	HANGERS
	J	HANGRAILS, BRACKETS, SHELVING, STANDARDS & ETC.
	K	LIGHTING
	L	MANNEQUINS & FORMS
	M	WIRE SHELVING SYSTEMS

TABLE OF CONTENTS

ICON	CHAPTER	CONTENTS
	N	OTHER STORE DISPLAYS
	O	OTHER STORE SUPPLIES
	P	PEGBOARD FIXTURE
	Q	PRICE MARKERS, LABELS & TAGS
	R	RACKS
	S	SECURITY DEVICES
	T	SHOWCASES, COUNTERS, MERCHANDISERS, TABLES, MIRRORS & ETC.
	U	SIGNHOLDERS
	V	SLATWALL
	W	SLOTTED TUBING
	X	TAG GUN & FASTENERS
	Y	WALL SYSTEMS
	Z	FACE-OUT & WATERFALLS

A

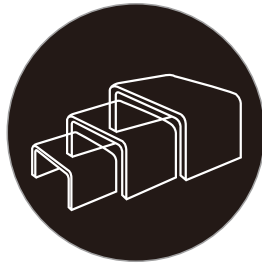

ACRYLIC

CHAPTER	DIVISION	CONTENTS
A	01	SHOE DISPLAYS & RISERS
	02	CARD HOLDERS
	03	TIE & BELT DISPLAY
	04	EASEL
	05	GRIDWALL ACCESSORIES
	06	SIGN HOLDER
	07	SLATWALL ACCESSORIES
	08	JEWELRY TRAY
	09	BALLOT BOX

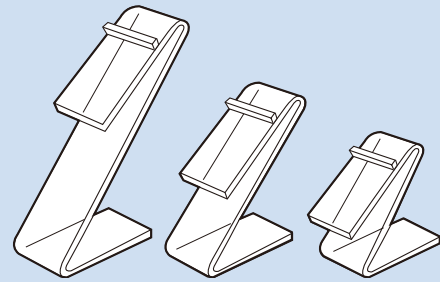
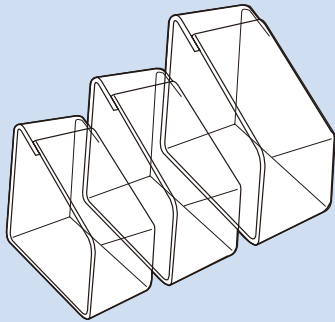
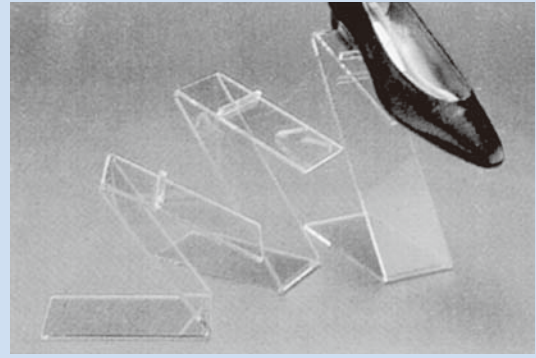
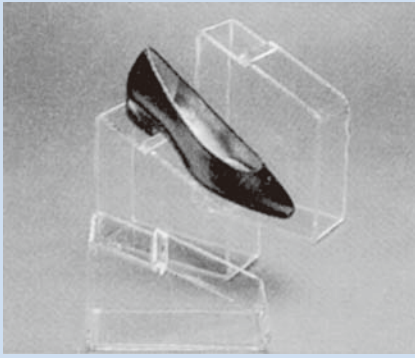
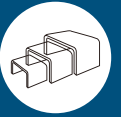

ACRYLIC G-BENDS FOR SHOES

Size: 3"W x 4½"H
3"W x 6½"H
3"W x 9½"H

1210-set of 3

ACRYLIC Z-BENDS FOR SHOES

Size: 3"W x 5"H
3"W x 6½"H
3"W x 8"H

1205-set of 3

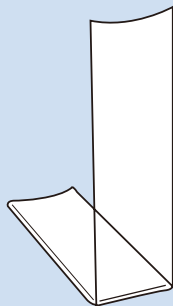
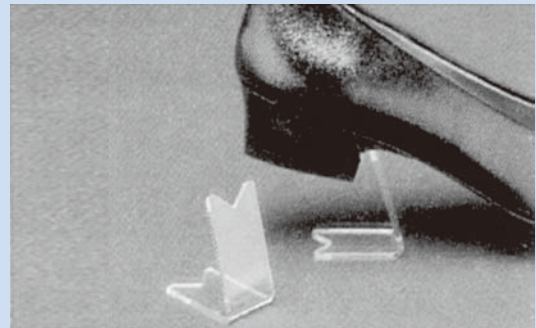
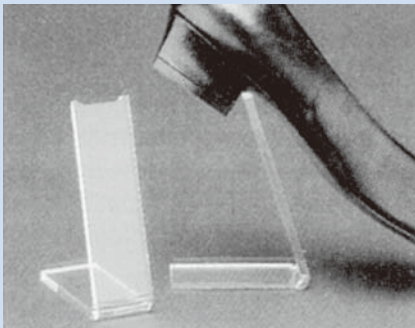

ACRYLIC HEEL REST

Size: 2"H

17X

ACRYLIC HEEL REST

Size: 4"H

1057

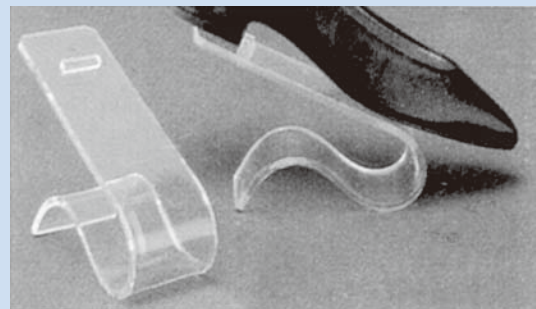

ACRYLIC HEEL REST

Size: 2" x 6-3/4" x 4"H

1039



SHOE DISPLAYS & RISERS

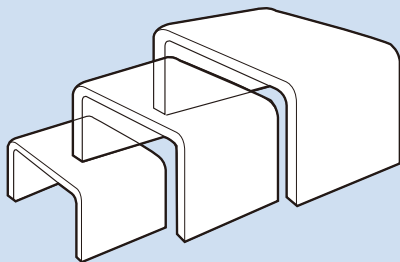

ACRYLIC SHOE RISER SET/3

Size: 6"L x 6"W x 4"H
8"L x 6"W x 6"H
10"L x 6"W x 8"H

D1052

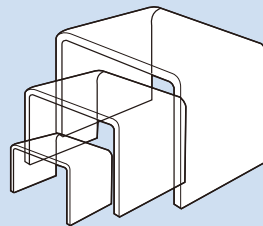

ACRYLIC SHOE RISER SET/3

Size: 3"L x 3"W x 3"H
4"L x 4"W x 4"H
5"L x 5"W x 5"H

228-1211

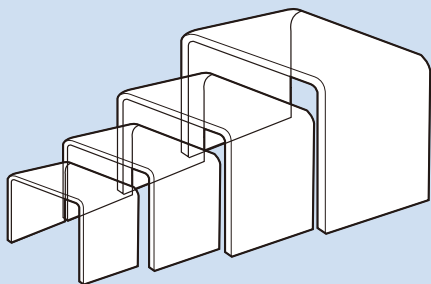

ACRYLIC SHOE RISER SET/4

Size: 6¼"L x 5⅞"W x 6⅛"H
7⅞"L x 7⅞"W x 8¼"H
10"L x 9⅞"W x 10¼"H
12⅞"L x 11⅞"W x 12⅛"H

228-1208

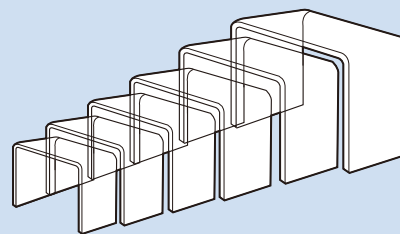

ACRYLIC SHOE RISER SET/6

Size: 4⅛"L x 3⅞"W x 3¼"H
4⅜"L x 3⅞"W x 3¾"H
5½"L x 3⅞"W x 4¼"H
6⅜"L x 3⅞"W x 4¾"H
6⅞"L x 3⅞"W x 5¼"H
7¼"L x 3⅞"W x 7⅛"H

228-1212

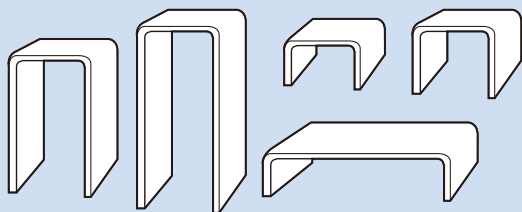

ACRYLIC SHOE RISER SET/5

Size: 6⅜"L x 5⅞"W x 9⅛"H
6⅜"L x 6"W x 12¼"H
6⅜"L x 5⅞"W x 3¼"H
6⅜"L x 5⅞"W x 6⅜"H
12⅜"L x 5⅞"W x 3¼"H

226-1100

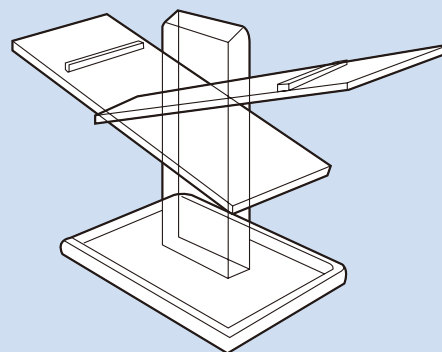

ACRYLIC COUNTER SHOE DISPLAY

Size: 8" x 8" x 11"H
Base: 5.0 mm thick
Shelf: 4.0 mm thick

ACSD

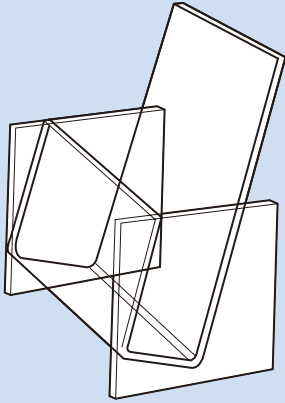

**ACRYLIC COUNTER TOP
BROCHURE HOLDER**

Holds 4"W × 9"H brochures
228-1100

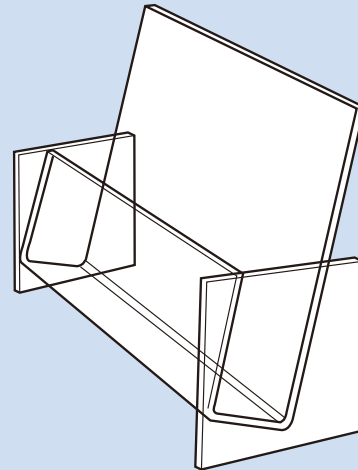

**ACRYLIC COUNTER TOP
BROCHURE HOLDER**

Holds 8"W × 9"H brochures
228-1103

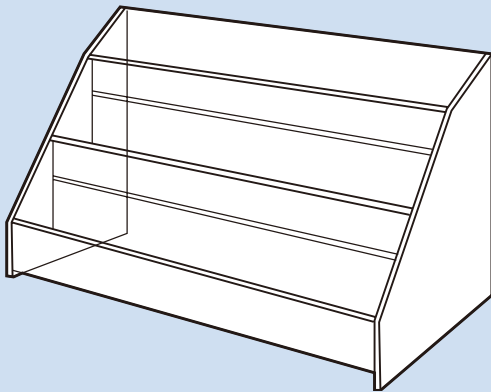

**3 TIER RACK FOR GREETING CARDS
& VIDEO CASSETTES**

Size: 21"W × 6"D × 11"H
Can be used on countertop or wall mounted.
Each shelf is 1¾" deep (inside).
(Assembly required)
226-1349

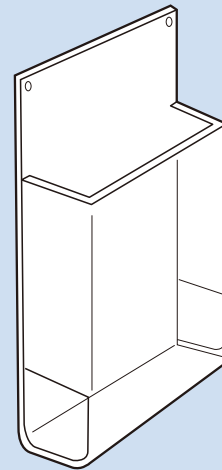

**ACRYLIC SINGLE BROCHURE
HOLDER**

For wall mount, With 2" deep pocket,
1/8" thick.
AC-1080 4"W × 9"H
AC-1084 8-1/2"W × 11-1/2"H

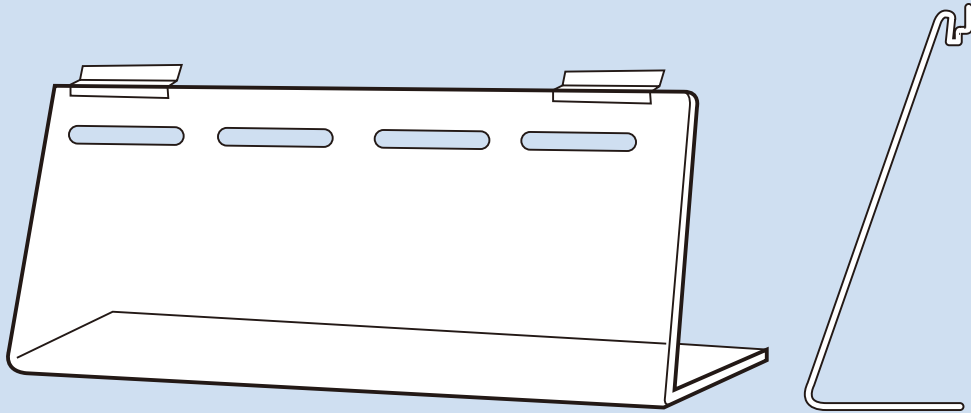
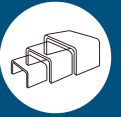

ACRYLIC TIE HOLDER FOR SLATWALL

Size: 24" × 10" × 4", 5mm thick

ATH

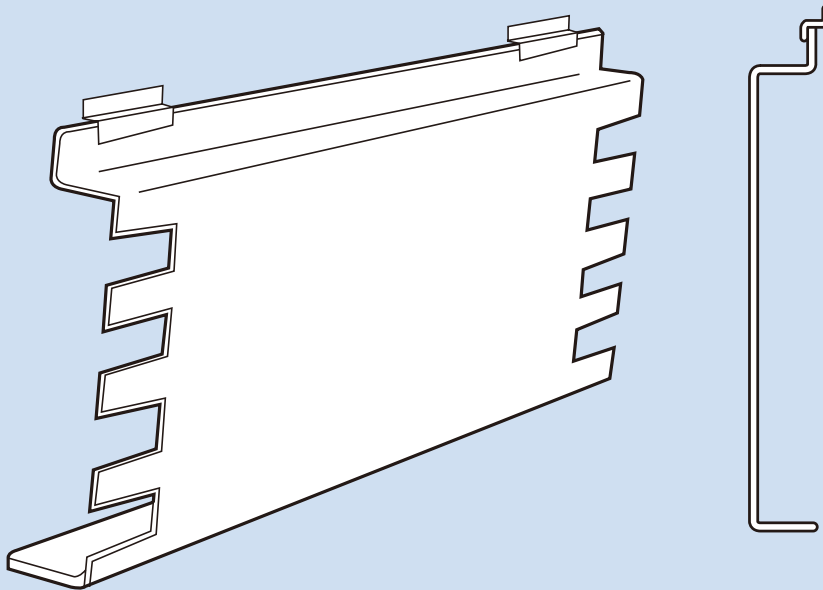

ACRYLIC BELT DISPLAY FOR SLATWALL

Size: 16" × 12" × 2", 3mm thick

ABD

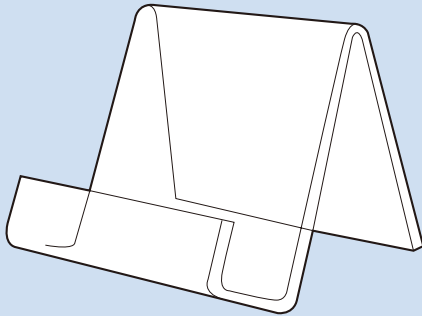

ACRYLIC EASEL

With 1" deep opening, 1/8" thick.

- # AC-1060 3-1/2"W × 4"H
- # AC-1062 5-1/2"W × 6"H
- # AC-1064 7-1/2"W × 8"H
- # AC-1066 9"W × 11"H

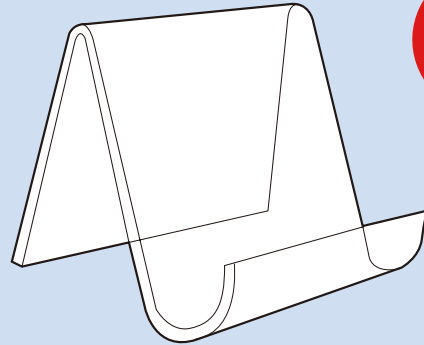

ACRYLIC WIDE OPEN EASEL

With 3" deep opening, 1/8" thick.

- 3-1/2"W × 5-1/2"H
- # AC-1061

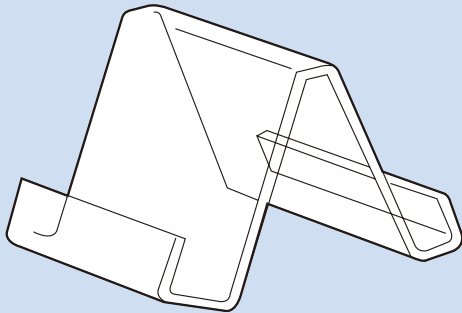

ACRYLIC COUNTER EASEL

12"× 9"× 13½", 3/16" thick

- # ACES

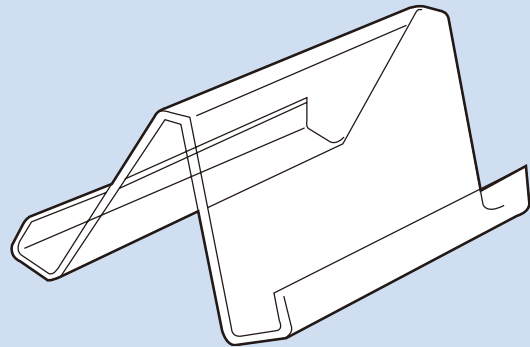

ACRYLIC COUNTER EASEL

12"× 23"× 13½", 3/16" thick

- # ACET

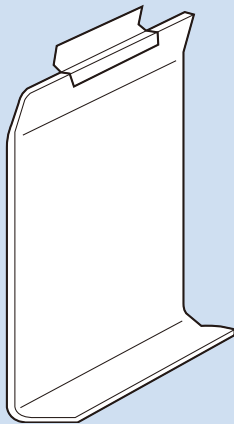

ACRYLIC SINGLE EASEL FOR SLATWALL

12"× 9"× 2", 3/16" thick

- # ASE-S

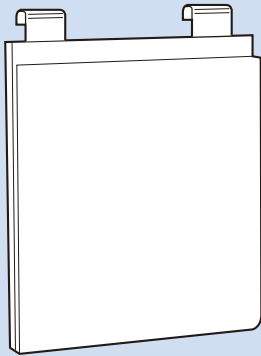
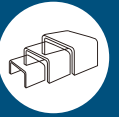
**ACRYLIC SIGNHOLDER**

Item	H × W
# JD516GW	7" × 5½"
# JD517GW	5½" × 7"
# JD518GW	11" × 7"
# JD519GW	7" × 11"
# JD522GW	14" × 11"
# JD523GW	11" × 14"

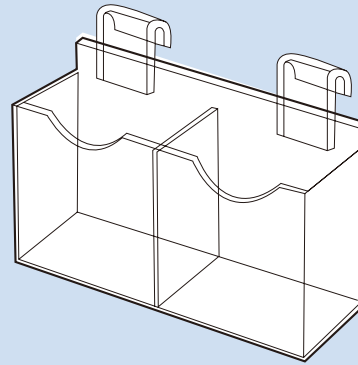
**ACRYLIC DOUBLE HOSEIERY BOX**

15" Wide × 6½" High × 4½" Deep

SP2047G

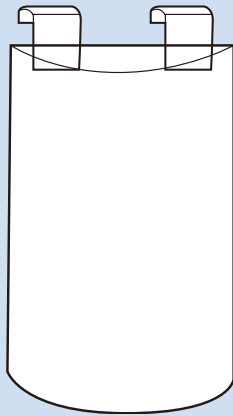
**ACRYLIC FASHION BELT DISPLAYER**

Half cylinder 19"H × 18"W

SP2018G

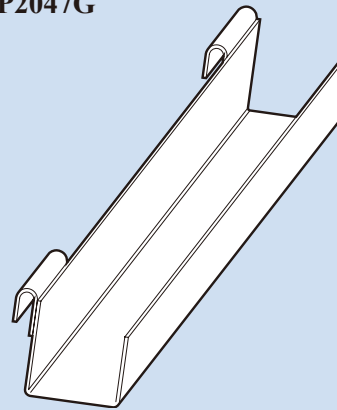
**ACRYLIC J-RACK SHELF**

2-1/2" front lip, 3-1/2" back.

Depth is 1-3/4" outside, 1-1/2" inside

G2270 11-3/4"L open both ends

G2275 23-3/4"L open both ends

G2291 35-3/4"L open both ends

G2292 47-3/4"L open both ends

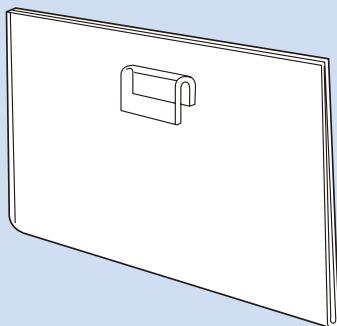
**ACRYLIC CARDFRAME**

Item	H × W
# GFRAME1	5½" × 7"
# GFRAME2	7" × 11"

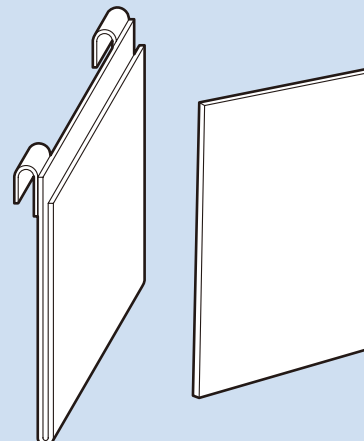
**ACRYLIC T-SHIRT DISPLAY**

Sleeve 11-1/2"W × 14"H × 1"D

Insert 11-1/4"W × 13-1/2"H

GTSHIRT



GRIDWALL ACCESSORIES

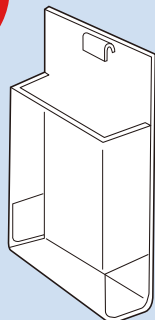

ACRYLIC SINGLE BROCHURE HOLDER

With 2" deep pocket, 1/8" thick.

AC-3111 4"W × 9"H

AC-3115 8-1/2"W × 11"H

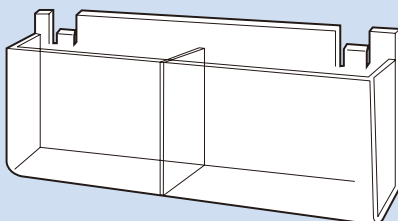

ACRYLIC DOUBLE BROCHURE HOLDER

Holds 8½" × 11" brochure

G3452

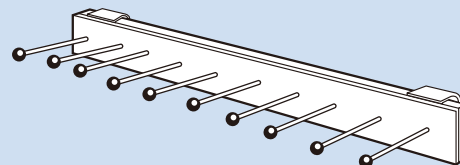

ACRYLIC BELT & TIE DISPLAY

G1979G 20"

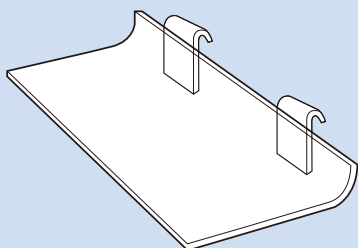

ACRYLIC SHELF

For Gridwall, 1/4" thick.

4"D × 9"W

AC-3001

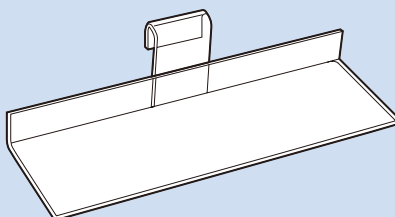

ACRYLIC SHOE SHELF

1/8" thick

JD651GW 3"D × 9"W

JD653GW 4"D × 9"W

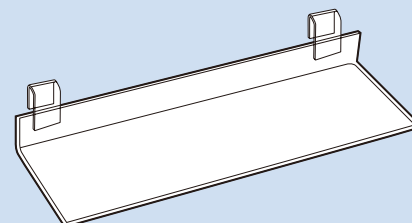

ACRYLIC SHOE SHELF

2.5mm thick

G3001 4"D × 9"W

G3002 4"D × 12"W

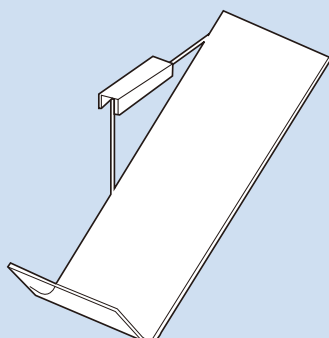

ACRYLIC LEFT SLANT SHOE SHELF

G10L 4"D × 9"W

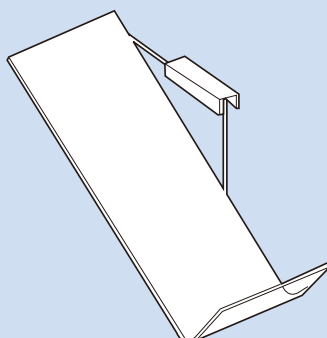

ACRYLIC RIGHT SLANT SHOE SHELF

G10R 4"D × 9"W

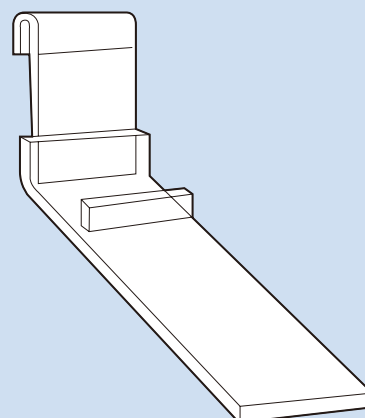

ACRYLIC SHOE SHELF

1972G-3 3"D × 8"W

1972G-4 4"D × 10"W

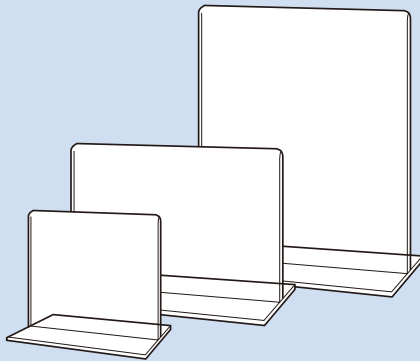

ACRYLIC BOTTOM LOADING SIGN HOLDER

Two Sided Self Standing

ITEM	H	×	W
# PG35	3½"	×	5"
# PG57	5½"	×	7"
# PG711	7"	×	11"
# PG811	8½"	×	11"
# PG35V	5"	×	3½"
# PG57V	7"	×	5½"
# PG711V	11"	×	7"
# PG811V	11"	×	8½"
# PG114V	14"	×	11"

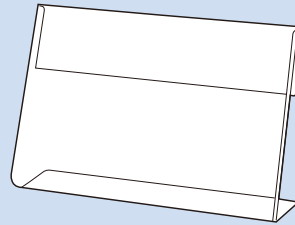

ACRYLIC SIGN HOLDER

Slant Self Standing

ITEM	H	×	W
# PH57	5½"	×	7"
# PH711	7"	×	11"

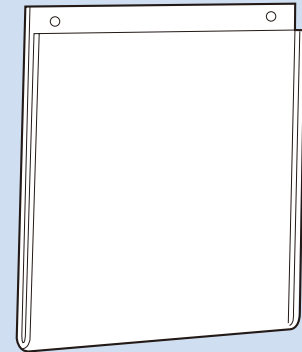

SCREW MOUNT OR HANGING SIGN HOLDER

Made of clear acrylic.
Edge finished and polished.

ITEM	H	×	W
# JD506	7"	×	5½"
# JD507	5½"	×	7"
# JD508	11"	×	7"
# JD509	7"	×	11"
# JD512	14"	×	11"
# JD513	11"	×	14"

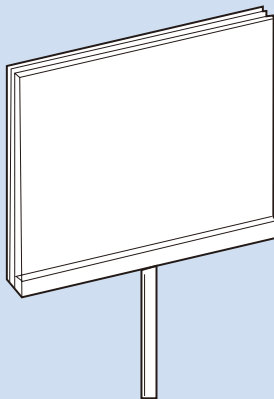

ACRYLIC SIGN HOLDER

with 3"L Swedge Stem

ITEM	H	×	W
# PJ57X	5½"	×	7"
# PJ711X	7"	×	11"

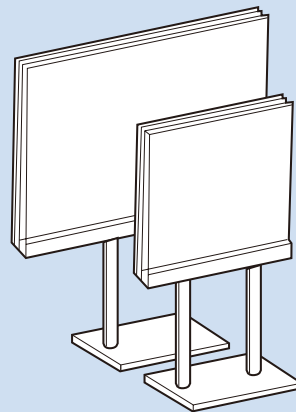

ACRYLIC SIGN HOLDER

Twin 4" Post with felt bottom
(Chrome channel 3½" × 5" base.)

ITEM	H	×	W
# SAP57	5½"	×	7"
# SAP711	7"	×	11"
# SAP57V	7"	×	5½"

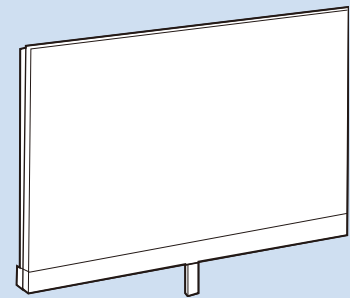

ACRYLIC SIGN HOLDER

with Chrome Channel
(Accepts ¼" or ⅜" stems.)

ITEM	H	×	W
# SA57	5½"	×	7"
# SA711	7"	×	11"
# SA711V	11"	×	7"



SIGN HOLDER



ACRYLIC ECONOMY BOTTOM LOADING SIGN HOLDER

With 2-sided sign holder,
1/16" thick.

ITEM	H	×	W
# AC-8151	5½"	×	3½"
# AC-8152	3½"	×	5½"
# AC-8160	5½"	×	7"

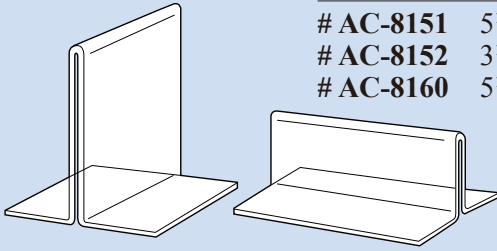

ACRYLIC TOP LOADING SIGN HOLDER

ITEM	H	×	W
# TL35H	3½"	×	5½"
# TL57H	5½"	×	7"
# TL711H	7"	×	11"
# TL114H	11"	×	14"
# TL811V	11"	×	8½"
# TL114V	14"	×	11"

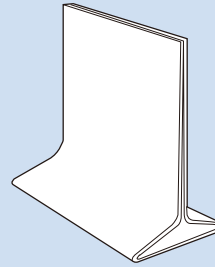

ACRYLIC ECONOMY SLANT BACK SIGN HOLDER

1/16" thick.

ITEM	H	×	W
# AC-8101	5½"	×	3½"

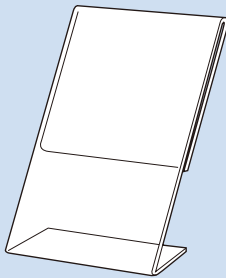

ACRYLIC SIGN HOLDER

Slant Self Standing

ITEM	H	×	W
# PH57V	7"	×	5½"
# PH711V	11"	×	7"
# PH811V	11"	×	8½"

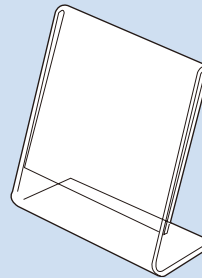

ACRYLIC SIGN HOLDER WITH LITERATURE POCKET

Holds 13"W × 11"H sign and dispenses
4"W × 9"H literature, 1-1/2" deep pocket
with 4" lip, 1/8" thick.

ITEM	H	×	W
# AC-1086	11"	×	13½"

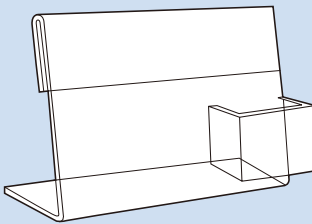

ACRYLIC SIGN HOLDER

Slant Self Standing

ITEM	H	×	W
# SH1411	14"	×	11"

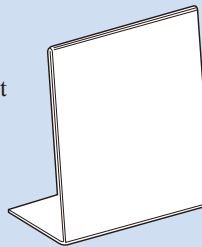

ACRYLIC ECONOMY SIGN HOLDER

For Slatwall, 1/16" thick.

ITEM	H	×	W
# AC-8029	5½"	×	3½"
# AC-8030	3½"	×	5½"
# AC-8032	5½"	×	7"

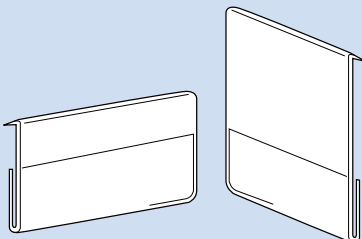

SIGN CLIP W/MOUNTING CLAMP

Sign clip 3-1/8" wide, Overall height 4-1/8" H,
Clamp fits up to 1-1/4" round, square or
rectangular tubing.

- # WB-48 Clear
- # WB-48B Black
- # WB-48W White

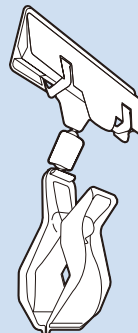

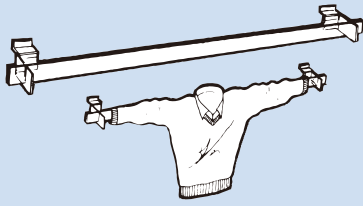
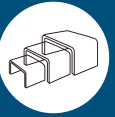
**Scarecrow Displayer**

47" wide extends out 2"

SP2171S

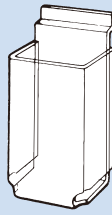
**Literature Displays**

4"W × 9"H × 2¼"D

DP2111

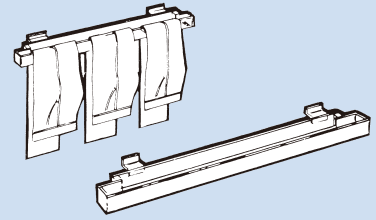
**Pants Bar Displayer**

Can also be used to drape towels, linens, etc. 2"H × 32"W

SP2168S

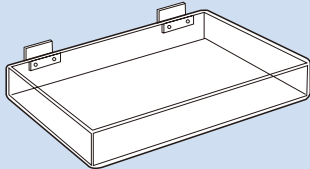
**Acrylic Tray**

Clear plexi all-purpose tray with two metal slatwall clips. ⅜" thick.

SP1994-10 10" × 14" × 2"

SP1994-8 8" × 12" × 2"

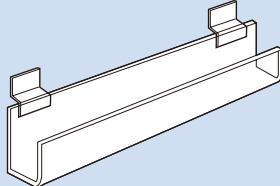
**Acrylic Universal Trough**

Ideal for video and computer cassettes and greeting cards. Slopes back to keep merchandise in place. Unit has 4" back, 3" front, 2" deep × 24" long.

JD416SL

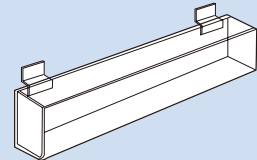
**Literature Displays**

For use with leaflets or brochures. 25"W × 3¾"H × 2½"D, ⅜" thick.

SP1998

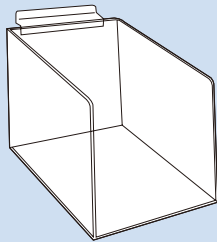
**Acrylic Tray**

10"W × 16"D × 10"H, ⅜" thick.

JD864SL

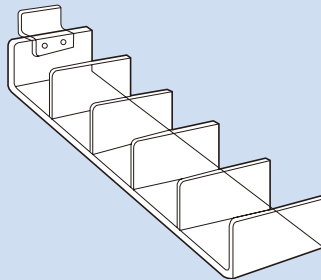
**Clutch Bag Displayer**

Holds 5 bags, 1/4" thick.

SP2007

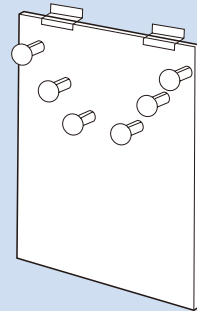
**Costume Jewelry Displayer**

18"H × 13"W. Six 3" rods with end caps for draping jewelry.

SP2117S

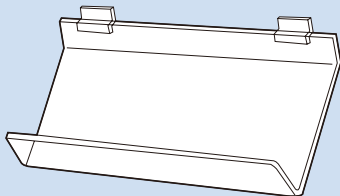
**Acrylic Downslant Shelf**

For shirts, linens, books, etc.

30"W × 13"D Tray with 1" front lip

DP2350

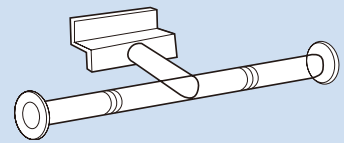
**Acrylic Jewelry Displayer**

1" rod 15¼" long extends 4" from wall.

SP2024S

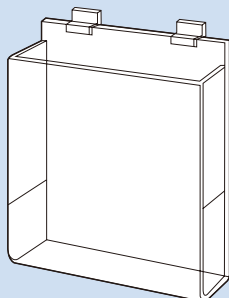
**Literature Displays**

9"W × 11"H × 2¾"D

DP2115

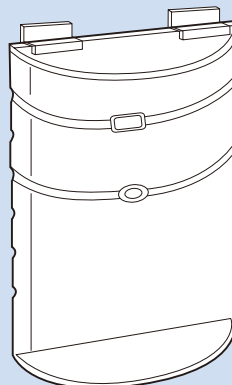
**Belt Displayer**

Half cylinder 18"W × 19"H

SP2018S

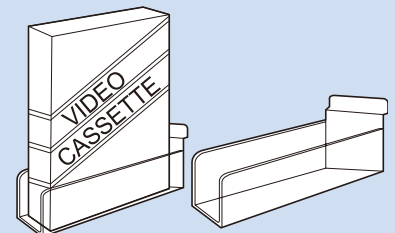
**Video Cassette Displayer**

ID860L -Left angle

ID860R -Right angle



SLATWALL ACCESSORIES

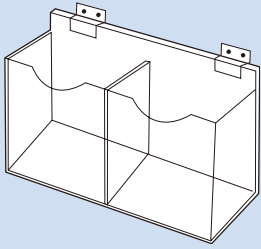

Double Hosiery Box
15" W × 6½"H × 4½" Deep
SP2074S

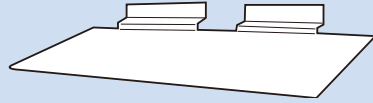

Clear Styrene Shoe Shelf
Injection Molded
SW410S 4" × 10"
SW612S 6" × 12"

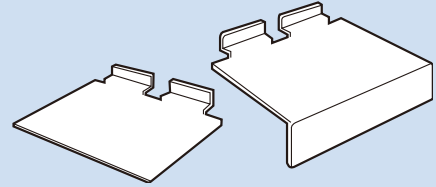

Children 3"x5" Shoe Displays
Ideal for displaying children's shoes, sneakers, etc. Available with or without 1" × 5" slot for product identification or pricing.
ID823 without sign slot
ID853 with sign slot

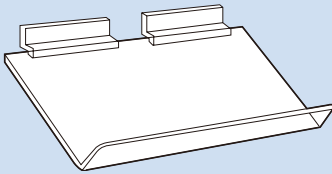

4" × 8" Down Slant Displayer
For use where frontal and top view is desired, Great for shoe, telephone and electronics display.
ID821

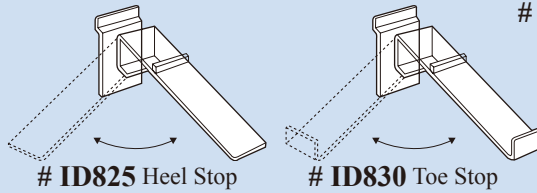

Down Slant Shoe Displays
For mens or ladies shoes. Displays shoes in any position left, right or front. 3½"x10"
ID825 Heel Stop
ID830 Toe Stop

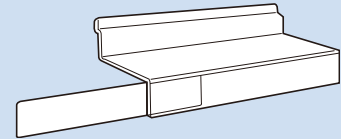

Clear Styrene Shoe Shelf with Sign Slot
3½" × 10" clear Shelf with slot for 2" × 10" card, Injection Molded, Ideal for product identification or pricing.
ID850

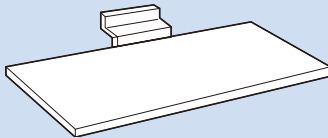

Acrylic Feature Shelf
JD654SL 5" W × 6"L
JD661SL 6" W × 12"L

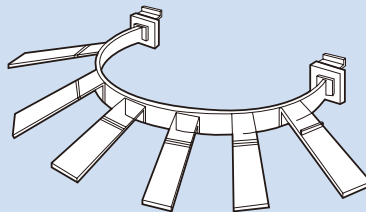

Curved Multi Shoe Displayer
6 shoe display with heel stops attaches to 15" wide curve.
SP1990

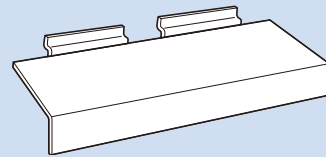

Clear Styrene Shoe Shelf with Sign Slot
4" × 10" clear Shelf with slot for 1.25" × 10" card, Injection Molded, Ideal for product identification or pricing.
ID851

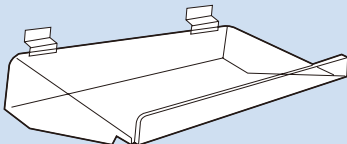

Acrylic Extra Support Shelf
⅜" clear acrylic with bent gussets for extra support.
JD870SL 8" W × 12"L
JD876SL 10" W × 16"L
JD878SL 10" W × 24"L
JD879SL 10" W × 36"L

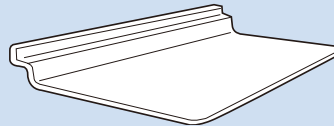

Slatwall Shoe Shelves
SW310 3" W × 10"L
SW48 4" W × 8"L
SW410 4" W × 10"L
SW412 4" W × 12"L



Acrylic Signholders
For Slatwall

Item	H × W
# JD516SW	7" × 5½"
# JD517SW	5½" × 7"
# JD518SW	11" × 7"
# JD519SW	7" × 11"
# JD522SW	14" × 11"
# JD523SW	11" × 14"

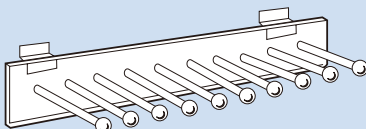

Acrylic Belt & Tie Displayer
20" wide, 10-2½" Chrome spokes for hanging.
SP1979S

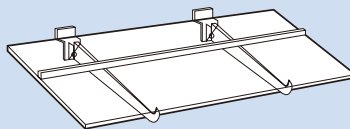

Acrylic Shoe Shelf
Heel stop-⅜" thickness
Brackets not included.
SW1024 10" × 24"
SW1048 10" × 48"
SW1224 12" × 24"
SW1248 12" × 48"

SLATWALL ACCESSORIES

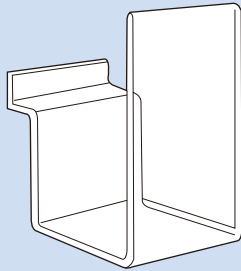

SLATWALL ACRYLIC VERTICAL DISPLAY FOR SHOES

Displays shoe bottom 3-1/2"W x 7"H

2365

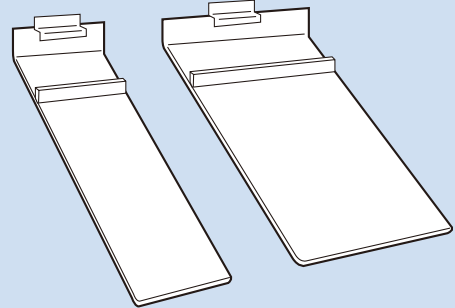

SLATWALL ACRYLIC SHOE FACEOUTS

Single wide

2084 -Heel hold 10"L x 3"W

Double wide

2086 -Heel hold 10"L x 7"W

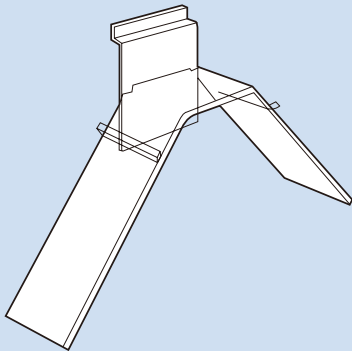

SLATWALL ACRYLIC DOUBLE SHOE SLANT

2 way

2081 -Heel hold - 16"L x 3"W

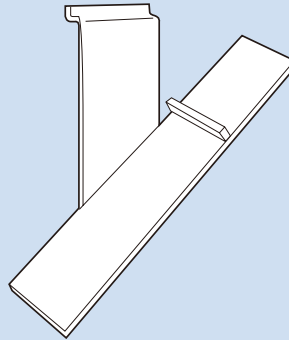

SLATWALL ACRYLIC LEFT SHOE SHELF

10"L x 3-3/8"W

2075 -1

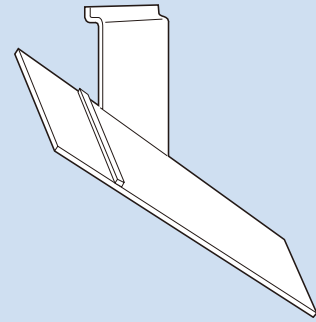

SLATWALL ACRYLIC RIGHT SHOE SHELF

10"L x 3-3/8"W

2073

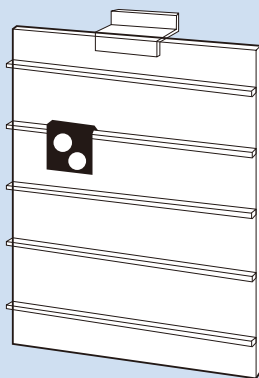

SLATWALL ACRYLIC EARRING PANEL

10"W x 14 1/4"H - Bronze back with channel for hanging 25-50 pair of carded earrings.

SP2118S

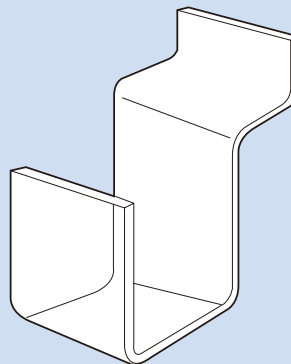

SLATWALL ACRYLIC HOOK

2240 - 1 1/2" wide

2" lip

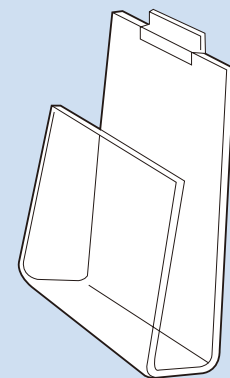

SLATWALL ACRYLIC HOLDER FOR BOOKS, VIDEO CASSETTES OR SOFTWARE

2170 - 4 1/4"W with 4 1/8" front lip. Holds items 7/8" to 1 1/4" thick



SLATWALL ACCESSORIES

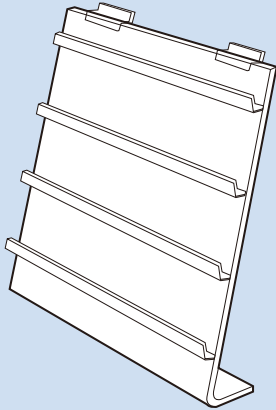

SLATWALL ACRYLIC JEWELRY CARD DISPLAY
8"W × 9"H
4 tiers high, holds 16-2" cards
2385

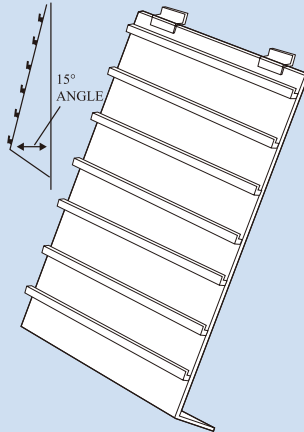

SLATWALL ACRYLIC JEWELRY CARD DISPLAY
15-7/16"W × 19"H
7 tiers high, holds 49-2" cards
226-2388

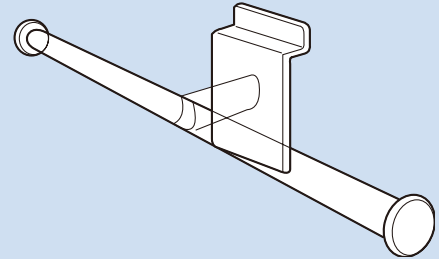

SLATWALL ACRYLIC JEWELRY T-BARS
Uses 1" diameter solid rod with 1-1/2" diameter ends 8" long
2326

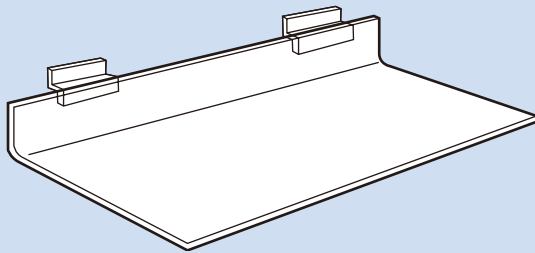

ACRYLIC FEATURE SHELF
12"W × 6-3/16"D
JD661SL-1

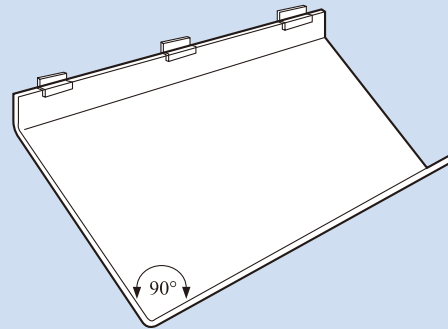

ACRYLIC SLANTED SHELF SLANT 45 DEGREE
23"W × 11-1/4"D with 1" front lip
226-2196

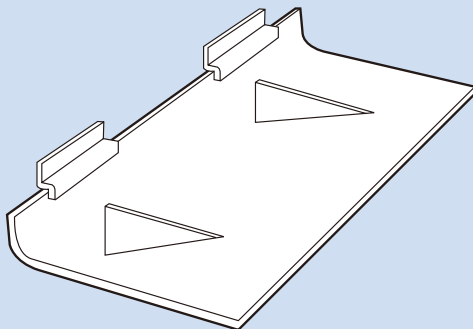

ACRYLIC DELUXE SHELF
16"W × 12"D
with 2 triangle supports on the bottom of shelf
226-2013

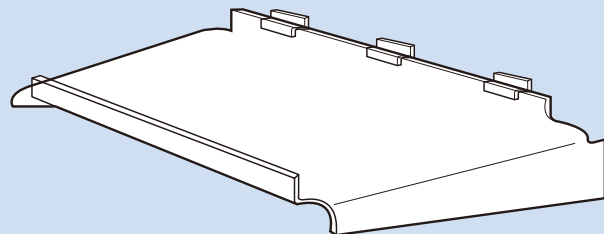

ACRYLIC EXTRA SUPPORT SHELF WITH BENT GUSSET
23-3/4"W × 14-5/8"D
226-2358

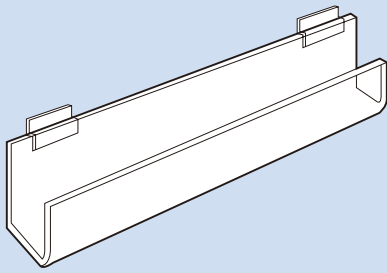

SLATWALL ACRYLIC J-RACK SHELVES

2-1/2" front lip, 3-1/2" back.
Depth is 1-3/4" outside, 1-1/2" inside
2270 11-3/4"L open both ends
2275 23-3/4"L open both ends
2291 35-3/4"L open both ends
2292 47-3/4"L open both ends

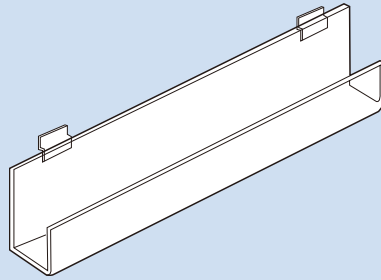

SLATWALL J-RACK TILT BACK SHELVES

With 20° tilt 23-3/4"L
open both ends
226-2375

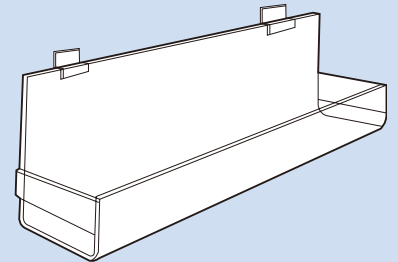

ACRYLIC STRAIGHT FLAT SHELF

23-13/16"W × 4-5/16"D
both ends closed
226-2364

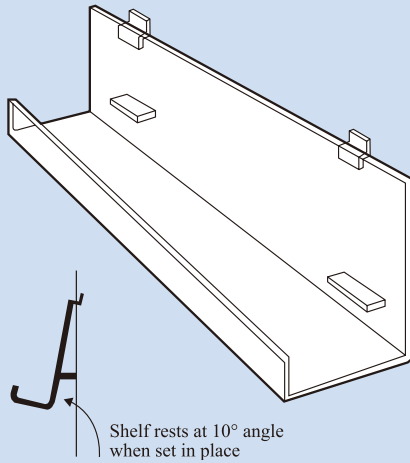

ACRYLIC LARGE TILT J-RACK SHELF

35-3/4" W × 5-7/8 " D
with 10 degree tilt
226-2308

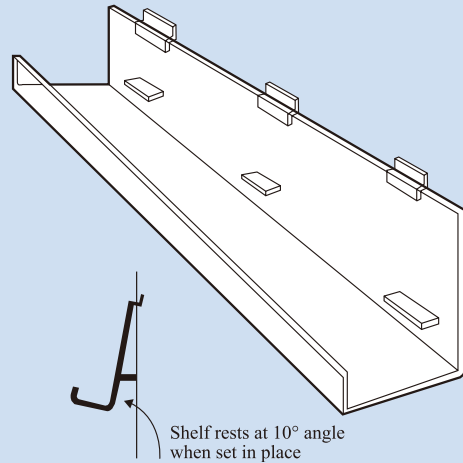

ACRYLIC LARGE TILT J-RACK SHELF

47-3/4" W × 5-7/8 " D
with 10 degree tilt
226-2309

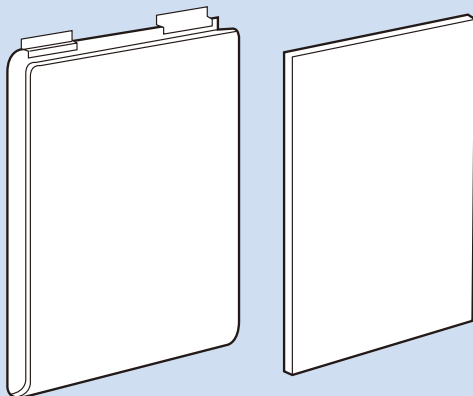

ACRYLIC T-SHIRT DISPLAY

sleeve 11-1/2" W × 14" H × 1" D
insert 11-1/4" W × 13-1/2" H
TSHIRT

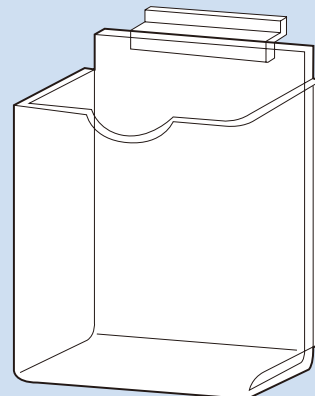

ACRYLIC SINGLE HOSEIERY BOX

7-1/2" W × 7-1/2 " H × 4" deep
HB1-SW



SLATWALL ACCESSORIES

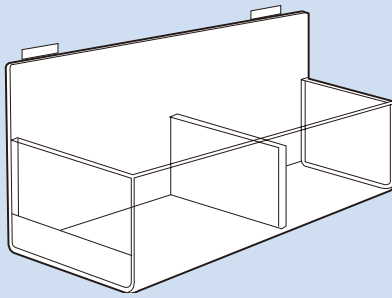

ACRYLIC HOSIERY BIN
16"wide × 4¾"Deep × 4½"H (Front)
Non-slanting back, double bin.
S2421



ACRYLIC SLATWALL MIRROR
S2062 8"W × 10"H
S2064 10"W × 14"H

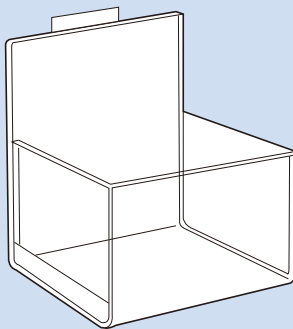

ACRYLIC HOSIERY BIN
7¾"wide × 4¾"Deep × 4½"H (Front)
Non-slanting back, single bin.
S2420

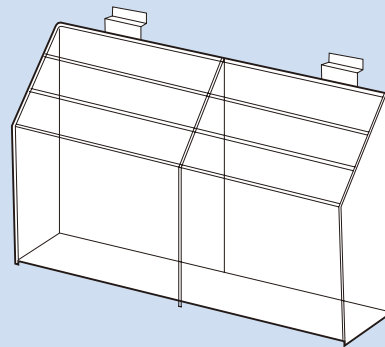

ACRYLIC BROCHURE HOLDER
Three tier. Fits slatwall for 8½" × 11" literature
S2119

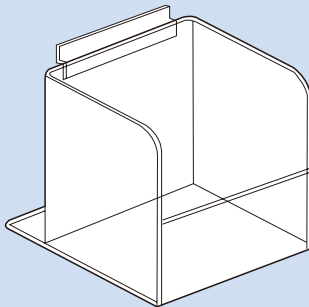

ACRYLIC HOSIERY BIN
Slant back single bin.
SE23

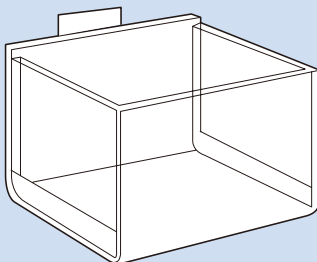

ACRYLIC GOLF GLOVE BIN
SGG1 5" × 5" × 5"

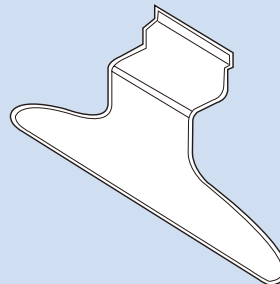

ACRYLIC DISPLAY HANGER
SHGR

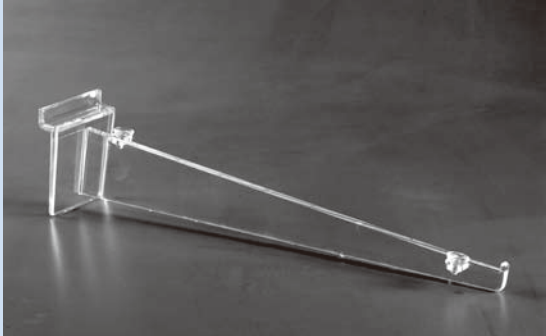
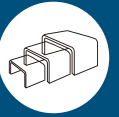

POLYCARBONATE SHELF BRACKET

With Suction Cups.

SW10KBPC 10"

SW12KBPC 12"

SW14KBPC 14"

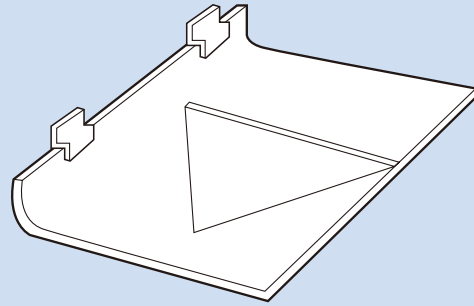

ACRYLIC 90° BRACED SHELF

With 1 triangle support on bottom of shelf, 1/4" thick.
9"W × 6"D

AC-2251

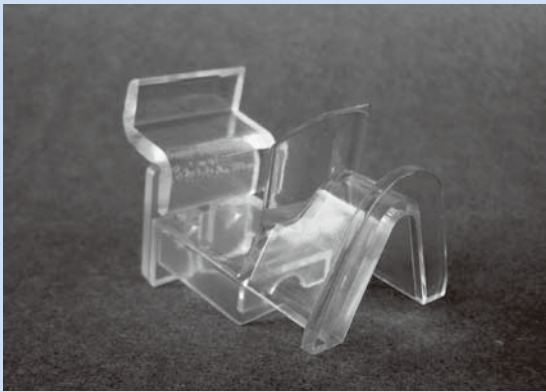

ACRYLIC SUNGLASSES SHELF

For Slatwall, 2-3/4"L

2191

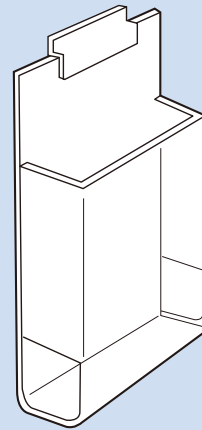

ACRYLIC SINGLE BROCHURE HOLDER

With 2" deep pocket, 1/8" thick.
8-3/4"W × 11"H

AC-2115

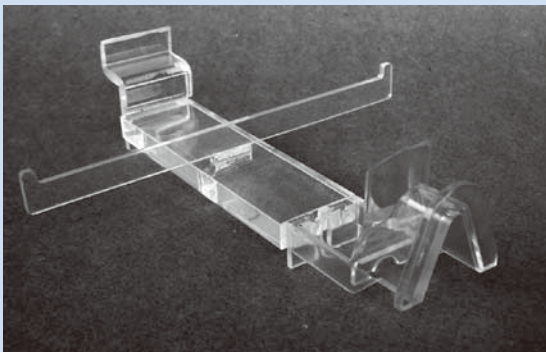

ACRYLIC SUNGLASSES SHELF

For Slatwall, 6-7/8"L × 5-15/16"W

2283

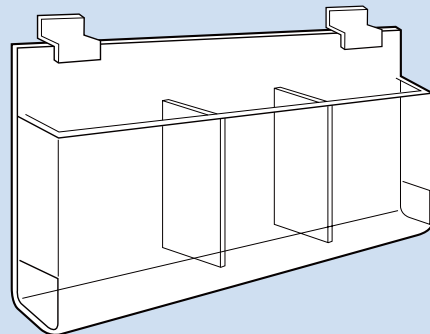

ACRYLIC TRIPLE BROCHURE HOLDER

With 1-7/8" deep pockets, 1/8" thick.
13"W × 9"H

AC-2444

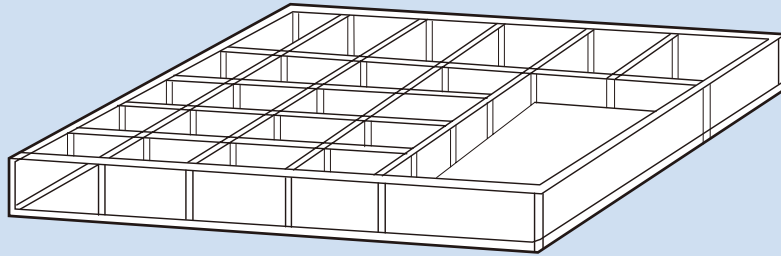

ACRYLIC JEWELRY TRAY

3/16" thick.
13-1/2"W × 9-1/2"D × 1-1/2"H
AC-2200

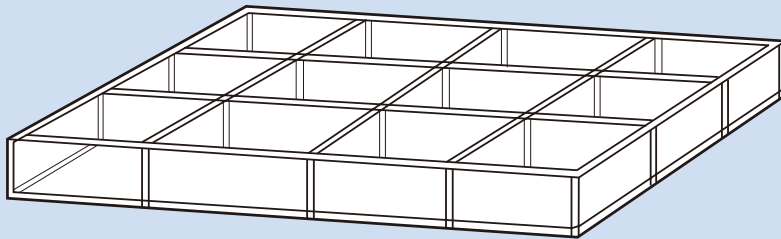

ACRYLIC JEWELRY TRAY WITH VELVET

3/16" thick.
9-1/8"W × 6-1/8"D × 1-1/4"H
AC-2201

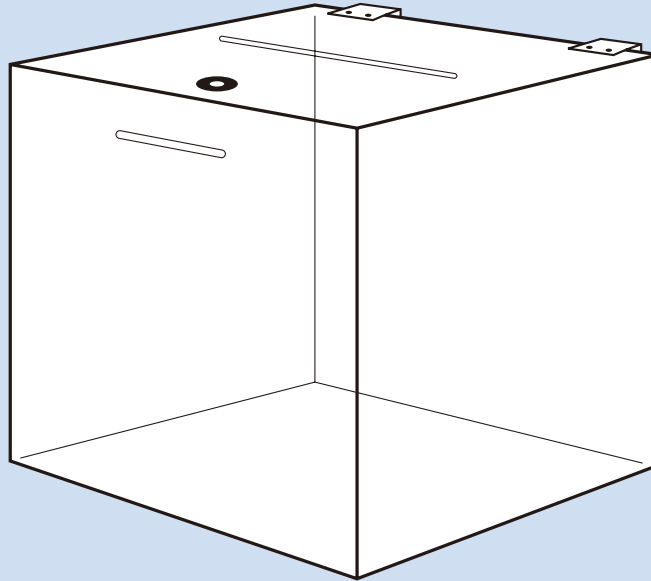

ACRYLIC BALLOT BOX

Includes lock and key,

3/8" thick.

10"W × 10"D × 10"H

AC-1025

B

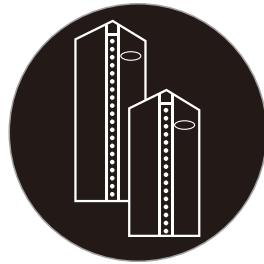

BAG & COVER

CHAPTER	DIVISION	CONTENTS
B	01	GARMENT BAG & COVER
	02	SALESMAN'S BAG & COVER
	03	PLASTIC SHOPPING BAG

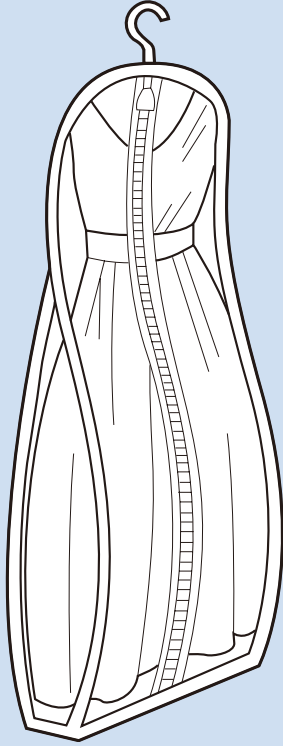

FULL LENGTH ZIPPERED UNPRINTED BELL BOTTOM GOWN BAG

72"L, Bottom 24"W
With 12" Gusset.
Heavyduty Crystal
Clear Vinyl.

B1-1

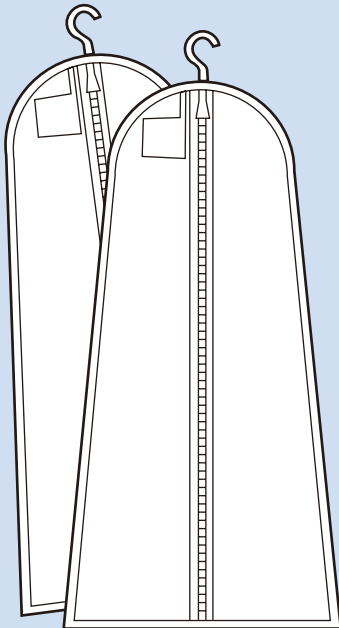
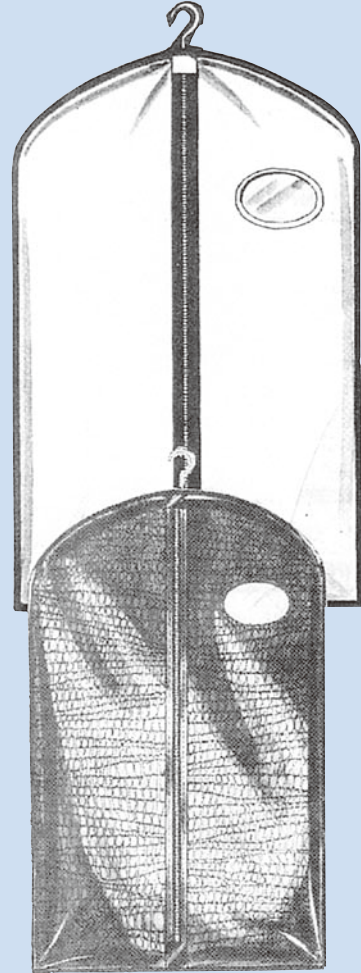

FULL LENGTH ZIPPERED BRIDAL GOWN BAGS

Unprinted, 36" x 72"
White Vinyl

BW72

VINYL ZIPPERED BAGS

Heavy-Duty 3 Gauge
Taffeta Finish

VZ40B-B

Black/Black Trim
24" Wide x 40" Long

VZ54B-B

Black/Black Trim
24" Wide x 54" Long



LOCKABLE GARMENT RACK COVER

Nylon Material, Navy Blue
60" L × 50" W
RCA100

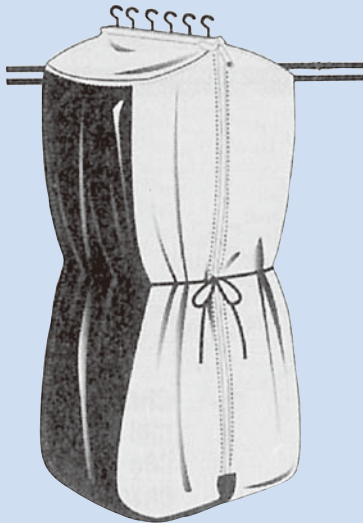

SALESMAN'S BAG

Canvas Material

Size	Navy Blue	Black
38" long	# BG38	# BG38-B
48" long	# BG48	# BG48-B
57" long	# BG57	# BG57-B
66" long	# BG66	# BG66-B
72" long	# BG72	# BG72-B

Nylon Material

Size	Navy Blue
38" long	# BG38N
48" long	# BG48N
57" long	# BG57N
66" long	# BG66N
72" long	# BG72N

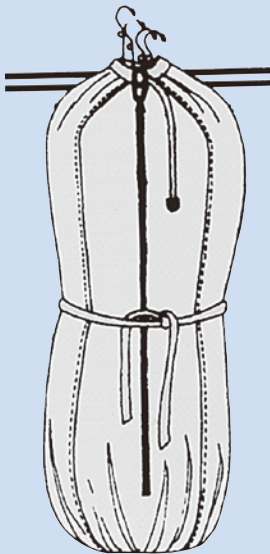

STRAP-TOP BAG

Canvas Material

Size	Navy Blue
38" long	# BS38
48" long	# BS48
57" long	# BS57



HIGH-DENSITY PLASTIC BAGS

ITEM#	SIZE	MIL	CTN PACK	NOTE	COLOR AVAILABLE
PB-619	6-1/4" × 9-1/4"	0.50	1000 PCS		All (10) Colors
PB-811	8-1/2" × 11"	0.50	1000 PCS		All (10) Colors
PB-1215	12" × 15"	0.55	1000 PCS		All (10) Colors
PB-1218	12" × 18" × 3"	0.60	500 PCS	With Die-cut Handle	All (10) Colors
PB-1421	13" × 21" × 3"	0.60	500 PCS	With Die-cut Handle	All (10) Colors
PB-1724	16" × 24" × 4"	0.65	500 PCS	With Die-cut Handle	All (10) Colors
PB-2030	20" × 30" × 4"	0.65	500 PCS		Red, White, Hunter Green

ALL (10) COLORS: YELLOW, RED, WHITE, HUNTER GREEN, SILVER,
POWDER BLUE, BURGUNDY, ROYAL BLUE, DUSTY ROSE, TEAL.

HOW TO ORDER EXAMPLE : 12" X 15" BAG IN YELLOW = PB-1215Y
(1 MIL = 0.0254MM)



PLASIC SHOPPING BAG



LOW-DENSITY PLASTIC BAGS

ITEM#	SIZE	MIL	CTN PACK	NOTE	COLOR AVAILABLE
PBK-912	9" × 12"	1.25	1000 PCS	With Die-cut Handle	All (12) Colors
PBK-1518	15" × 18" × 4"	1.25	500 PCS	With Die-cut Handle	All (12) Colors
PBK-2020	20" × 20" × 5"	1.50	500 PCS	With Die-cut Handle	All (12) Colors
PBK-3625	36" × 25" × 5"	1.75	250 PCS	With Die-cut Handle	White Only

ALL (12) COLORS: WHITE, TEAL, DUSTY ROSE, GRAY, BURGUNDY, IVORY, NAVY, BLACK, ROYAL BLUE, GOLD, DARK GREEN, RED.

HOW TO ORDER EXAMPLE : 9" × 12" BAG IN WHITE = PBK-912W
(1 MIL = 0.0254MM)

C

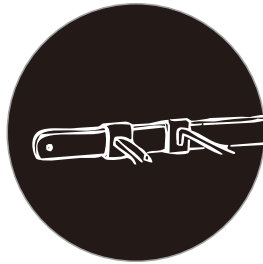

CROSSBAR

CHAPTER	DIVISION	CONTENTS
C	01	CROSSBAR & ACCESSORIES

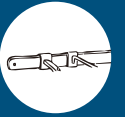

FOR 1/2" SLOTS ON 1" CENTERS

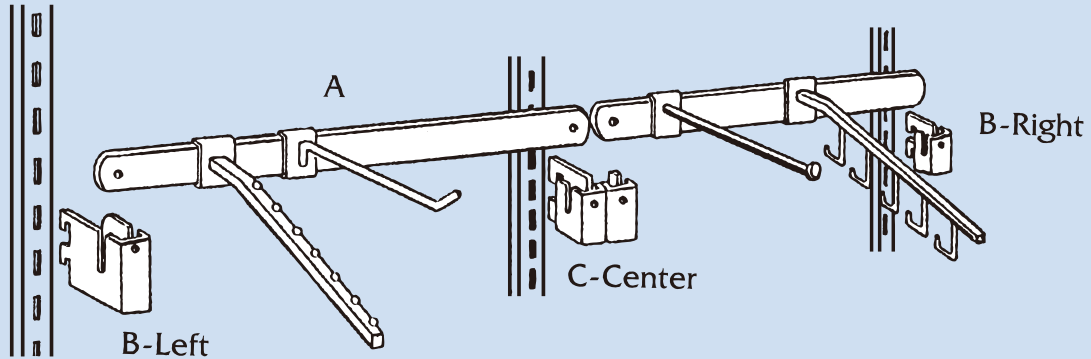

A. CROSSBARS

3/16" x 1" Chrome

Item	Length
# 3700-24	24"
# 3700-30	30"
# 3700-48	48"
# 3700-60	60"

B. CROSSBAR BRACKETS LEFT AND RIGHT

Chrome

Left	Right	Length
# 3946-1	# 3947-1	1"
# 3946-3	# 3947-3	3"
# 3946-6	# 3947-6	6"
# 3946-9	# 3947-9	9"

C. CROSSBAR BRACKETS CENTER

Chrome

Item	Length
# 3948-1	1"
# 3948-3	3"
# 3948-6	6"
# 3948-9	9"

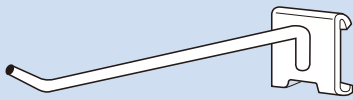

CROSSBAR HOOK

1/4" Chrome

Item	Length
# CB6	6"
# CB9	9"
# CB12	12"

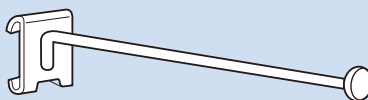

STRAIGHT ROD

5/16" dia., 12" Length,
1" disk end
Chrome
3306-12

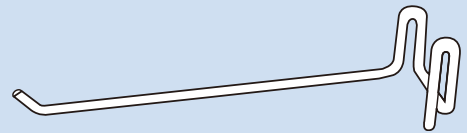

CROSSBAR HOOK

Chrome

Item	Length
# CDCBH-6C	6"
# CDCBH-9C	9"

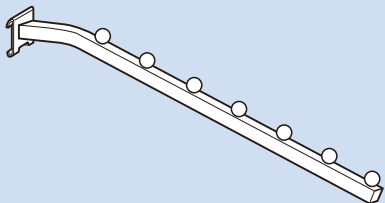

WATERFALL, 7 BALLS

3/4" square tube,
18" long, Chrome
WR7B

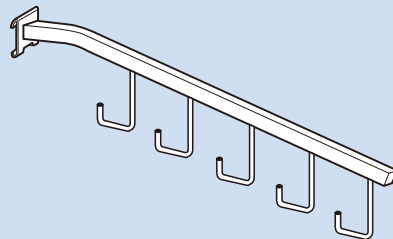

WATERFALL, 5 HOOKS

3/4" square tube,
18" long, Chrome.
WR5H



5-HOOK WATERFALL

3/8" Dia. Rod 16" long,
Chrome
G8442CS

D



CUBBIES

CHAPTER	DIVISION	CONTENTS
D	01	GLASS + WIRE GRID CUBES
	02	MODULAR WIRE GRID CUBES

GLASS + WIRE GRID CUBES

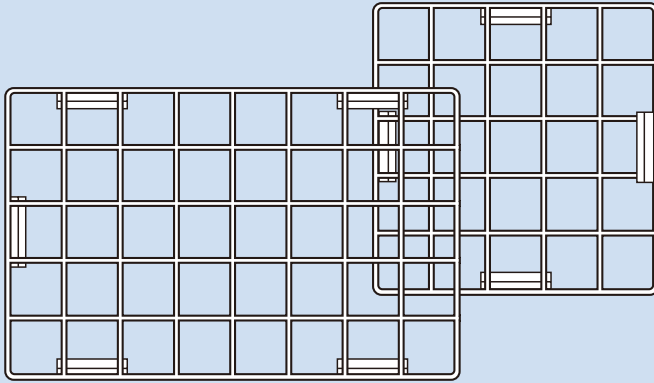

GRID CUBE PANELS

Single beaded 3/16" exterior wire grid panel with rounded corners and 0.11" interior wire in 2" square pattern

Chrome Plated	Black Epoxy	White Epoxy	Size
WG1010	WG1010B	WG1010W	10" × 10"
WG1016	WG1016B	WG1016W	10" × 16"
WG1212	WG1212B	WG1212W	12" × 12"
WG1216	WG1216B	WG1216W	12" × 16"
WG1414	WG1414B	WG1414W	14" × 14"
WG1616	WG1616B	WG1616W	16" × 16"



TEMPERED CUBE GLASS PANELS

1/4" thick, with pencil polished edges.

Item #	Size
GS1024T	10" × 24"
GS1036T	10" × 36"
GS1048T	10" × 48"
GS1224T	12" × 24"
GS1236T	12" × 36"
GS1248T	12" × 48"
GS1424T	14" × 24"
GS1436T	14" × 36"
GS1448T	14" × 48"

TEMPERED CUBE GLASS PANELS

3/16" thick, with pencil polished edges.

Item #	Size
GC1010T	10" × 10"
GC1012T	10" × 12"
GC1014T	10" × 14"
GC1016T	10" × 16"
GC1024T	10" × 24"
GC1048T	10" × 48"
GC1212T	12" × 12"
GC1214T	12" × 14"
GC1216T	12" × 16"
GC1224T	12" × 24"
GC1248T	12" × 48"
GC1414T	14" × 14"
GC1416T	14" × 16"
GC1424T	14" × 24"
GC1448T	14" × 48"

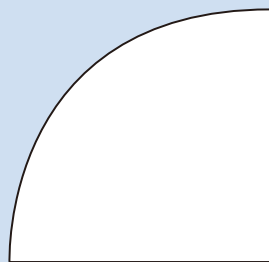

QUARTER ROUND GLASS PANELS

3/16" thick, with pencil polished edges.

Item #	Size
GQR10T	10" × 10"
GQR12T	12" × 12"
GQR14T	14" × 14"
GQR16T	16" × 16"



GLASS + WIRE GRID CUBES

Binning Connectors



CON2
2 Way 90°

- Durable zinc die casting connectors with reinforced nylon screw
- Chrome plated and brass plated.
- Fits up to 3/16" glass
- for tempered glass only



CON3
3 Way 90°

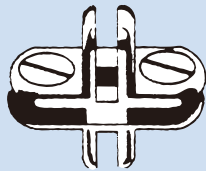

CON4
4 Way 90°



CON2-N
2 Way 120°

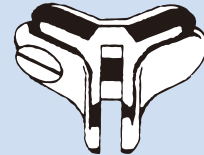

CON3-N
3 Way 120°

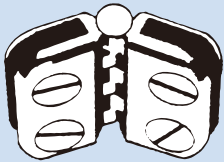

CON2-HD
2 Way H/D Hinge

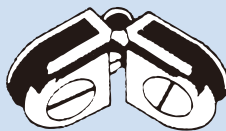

CON2-H
2 Way Hasp,
w/out pin



CON2-H1
2 Way Hinge,
With pin



MS3
3 Way Adjustable



MS4
4 Way adjustable

Lexan Unbreakable ■ Crystal Clear ■ Fits 3/16" Glass

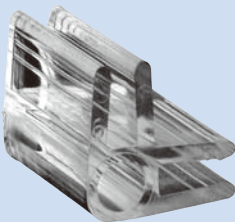

2WC
2 Way Clip

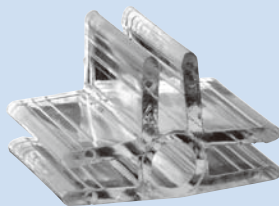

3WC
3 Way Clip

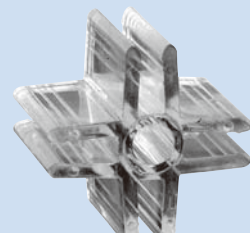

4WC
4 Way Clip



CN1
Screwdriver

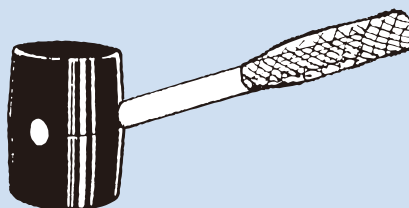

RM9
Rubber Mallet

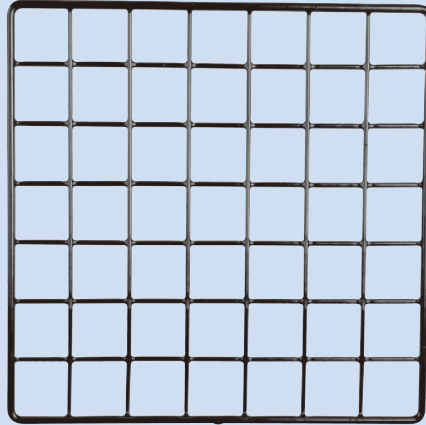

Plastic Coated Grid Panels
(1-1/2" Grid)

Black	White	Red	Sizes
# GS14B	# GS14W	# GS14R	14" x 14"
# GS16B	# GS16W	# GS16R	10" x 16"
# GS10B	# GS10W	# GS10R	10" x 10"

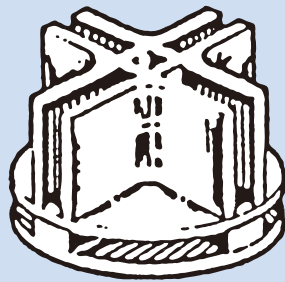

8-Way Plastic Connectors

- # GSC-B Black
- # GSC-W White
- # GSC-R Red



Wire Grid "S" Hooks

- 2-3/4"L, 4.0mm dia.wire
- Chrome plated
- # GSH

E

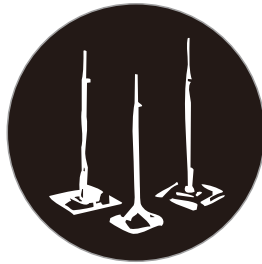

DISPLAY STANDS & TOPS

CHAPTER	DIVISION	CONTENTS
E	01	ROUND BASE DISPLAY FIXTURES
	02	PARSONS BASE DISPLAY FIXTURES
	03	SQUARE BASE DISPLAY FIXTURES
	04	TRUMPET BASE DISPLAY FIXTURES
	05	COUNTER TOP STAND

ROUND BASE DISPLAY FIXTURES

STANDS



Polished Chrome

4" BASE

- 409 - 9" to 18" adjustable stand
- 412 - 12" to 24" adjustable stand
- 415 - 15" to 30" adjustable stand
- 418 - 18" to 36" adjustable stand

5" BASE

- 509 - 9" to 18" adjustable stand
- 512 - 12" to 24" adjustable stand
- 515 - 15" to 30" adjustable stand
- 518 - 18" to 36" adjustable stand

Above stands have 1/4" diameter inner rod with 1/4-20 thread and 3/8" diameter outer tube.

6" BASE

- 618 - 18" to 36" adjustable stand
- 624 - 24" to 48" adjustable stand
- 625 - 5/8" × 24" (not adjustable)

8" BASE

- 818 - 18" to 36" adjustable stand
- 824 - 24" to 48" adjustable stand
- 830 - 5/8" × 30" (not adjustable)
- 836 - 36" to 72" adjustable stand

Above adjustable stands have 3/8" diameter adjustable inner tube with 3/8-27 thread and 5/8" diameter outer tube with 5/8-27 thread.

10" BASE

- 1036 - 7/8" X 36" (not adjustable)

Components for Display Stands

METAL BASES ONLY

- # MB4 4" Bases
- # MB5 5" Bases
- # MB6 6" Bases
- # MB8 8" Bases
- # MB10 10" Bases

UPRIGHTS ONLY

- # E1-1 3/8" × 9" × 18" (adjustable)
- # E1-2 3/8" × 12" × 24" (adjustable)
- # E1-3 3/8" × 15" × 30" (adjustable)
- # E1-4 3/8" × 18" × 36" (adjustable)
- # E1-5 5/8" × 18" × 36" (adjustable)
- # E1-6 5/8" × 24" × 48" (adjustable)
- # E1-7 5/8" × 36" × 72" (adjustable)
- # E1-8 5/8" × 24" (not adjustable)
- # E1-9 5/8" × 30" (not adjustable)
- # E1-10 7/8" × 36" (not adjustable)

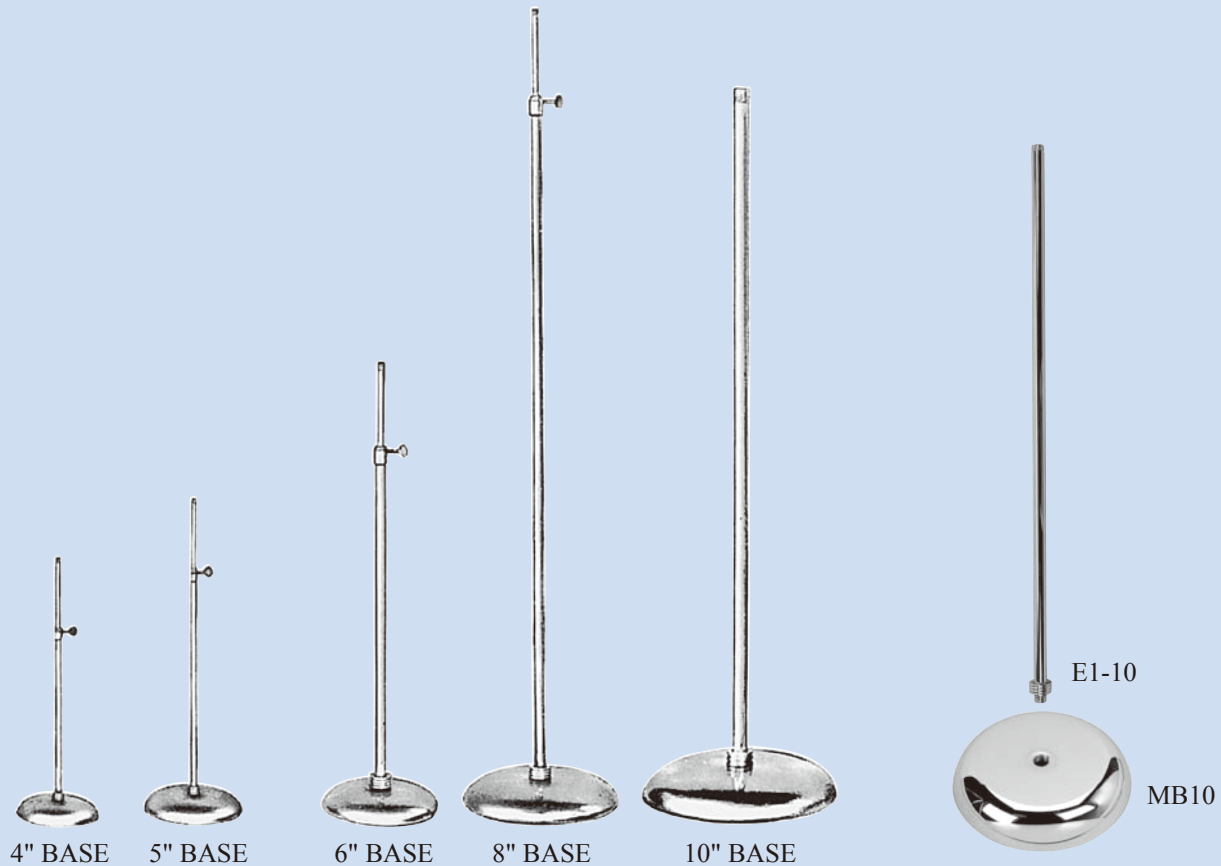



ROUND BASE DISPLAY FIXTURES TOPS



TWO BALL TENT DISPLAY TOP

DT2 - Has 1/4" and 3/8" fitting



1/4" WIRE - 1/4" FITTING

BT12 - Blouse Top-12" wide

BT15 - Blouse Top-15" wide



WALL FIXTURES

POR12 - Pull Out Rod-12"

POR18 - Pull Out Rod-18"



1/4" WIRE - 1/4" FITTING

TT12 - Tee Top-12" wide

TT15 - Tee Top-15" wide



3/8" WIRE - 3/8" FITTING

HT15 -Tee Top-15" wide

HT18 -Tee Top-18" wide

HT21 -Tee Top-21" wide

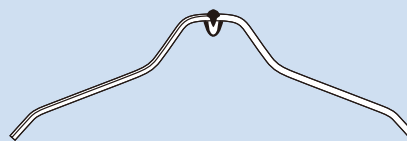

3/8" WIRE - 3/8" FITTING

E1-11 - Dress Top-17" wide



3/8" FITTING

SDT2 -Scroll Drapery Top

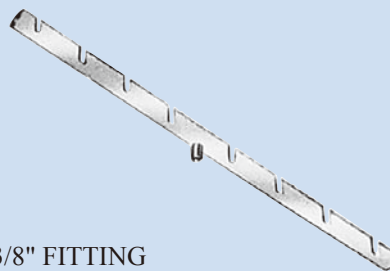

3/8" FITTING

RT8N -Ratchet Top 8 notches



3/8" FITTING

RDT3 -3 Ring Drapery Top

PARSONS BASE DISPLAY FIXTURES

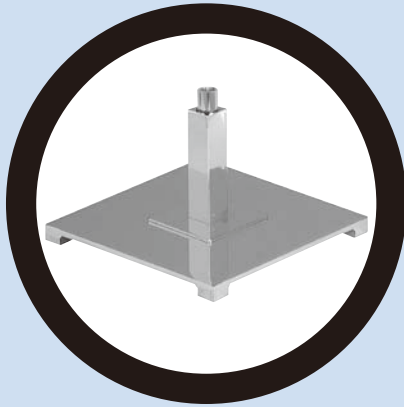

PARSONS BASE

- PB5** - 5" Base
- PB6** - 6" Base
- PB8** - 8" Base
- PB10** - 10" Base

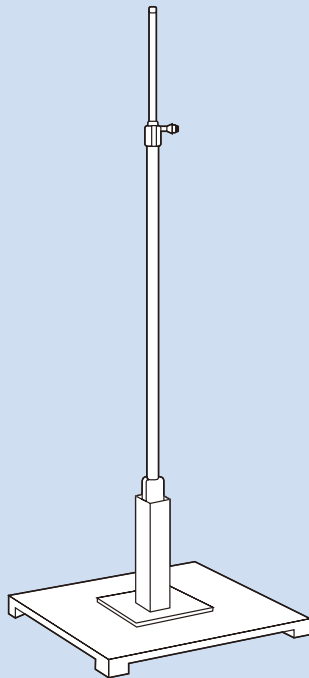

Parsons Base

PARSONS BASE

- PB5-3809** - 5" Base, 3/8" × 9" × 18" upright
- PB5-3812** - 5" Base, 3/8" × 12" × 24" upright
- PB5-3815** - 5" Base, 3/8" × 15" × 30" upright
- PB5-3818** - 5" Base, 3/8" × 18" × 36" upright

- PB6-5818** - 6" Base, 5/8" × 18" × 36" upright
- PB6-5824** - 6" Base, 5/8" × 24" × 48" upright
- PB6-5836** - 6" Base, 5/8" × 36" × 72" upright

- PB8-5818** - 8" Base, 5/8" × 18" × 36" upright
- PB8-5824** - 8" Base, 5/8" × 24" × 48" upright
- PB8-5836** - 8" Base, 5/8" × 36" × 72" upright



PARSONS BASE DISPLAY FIXTURES

WATERFALL DISPLAYERS

BLOUSE DISPLAYERS



PB8-1825
Tent style, 10 balls,
8" base, 5/8" × 18/36" extension



PB8-1821
Single slant, 6 hooks,
8" base, 5/8" × 18/36" extension.



PB6-E4-3
Adjustable gooseneck
with waist cincher, 6" base, 5/8" ×
18/36" extension, 16" hanger.

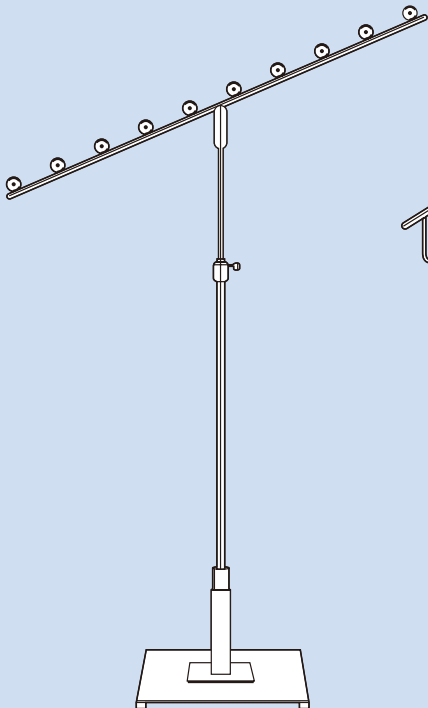

PB8-1820
Single slant, 10 balls,
8" base, 5/8" × 18/36" extension.

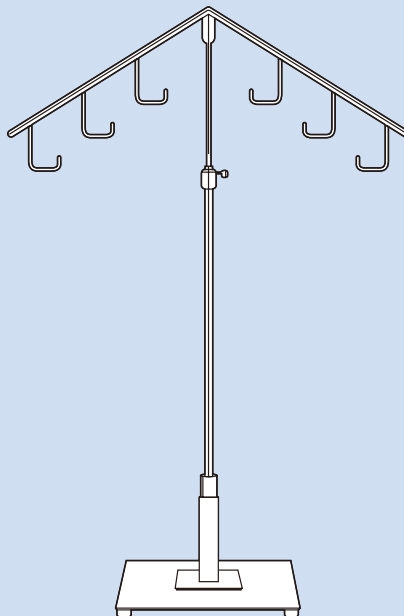

PB8-1826
Tent style, 6 hooks,
8" base, 5/8" × 18/36" extension.

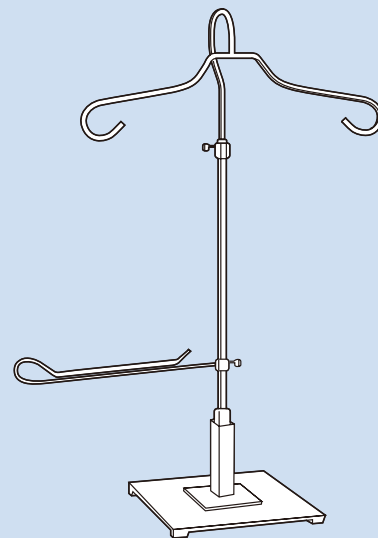

PB8-1816
Adjustable gooseneck
with 11" skirt or slack arm, 8" base,
5/8" × 18/36" extension, 16" hanger.

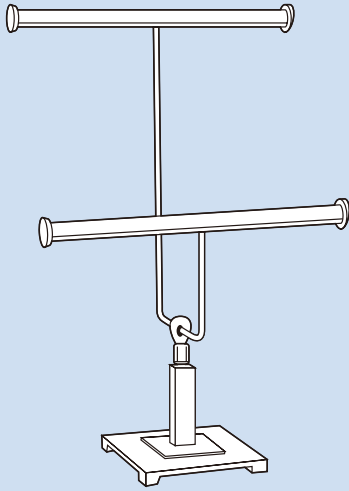

JEWELRY DISPLAYERS

**PB6-1830**

Necklace and bracelet stand.
6" base, 15" round lucite bars.

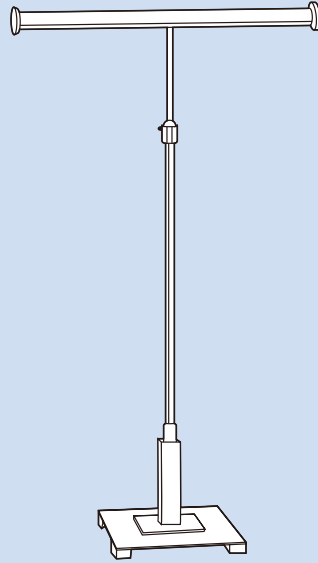
**PB6-1832**

Rope stand, 6" base, adjustable
5/8" × 18/36" extension,
15" round lucite bar.

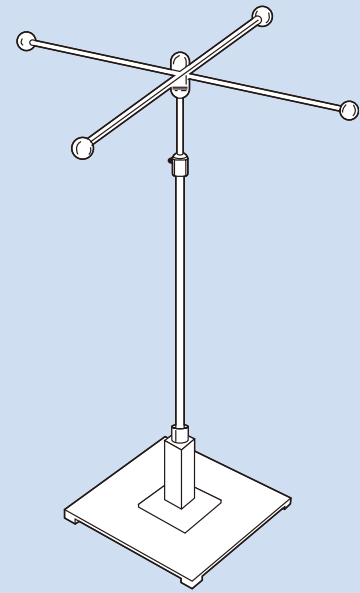
**PB8-1834**

Revolving rope stand, 8" base,
adjustable 5/8" × 18/36" extension,
15½" diameter, 4 arms ball bearing
fitting.

MIRROR

**PB6-E4-1**

Oval double face,
with tilt fitting,
10" × 14", 6" base.

REVOLVING DISPLAYERS

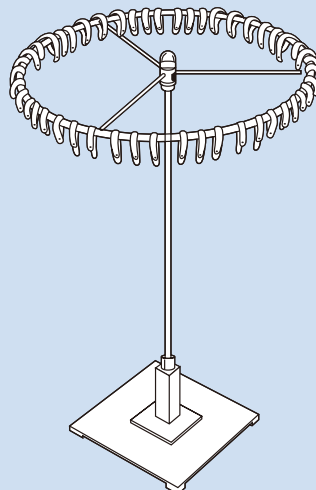
**PB8-3010**

Scarf stand, 8" base, 5/8" × 18/36"
extension, 14" diameter, ball
bearing fitting- not including 100
plastic clips.

**PB10-3012**

Tie stand, 10" base, 5/8" × 31"
upright, 17" diameter, ball bearing
fitting, 12 spokes for hook riders.



PARSONS BASE DISPLAY FIXTURES

SHELF STANDS

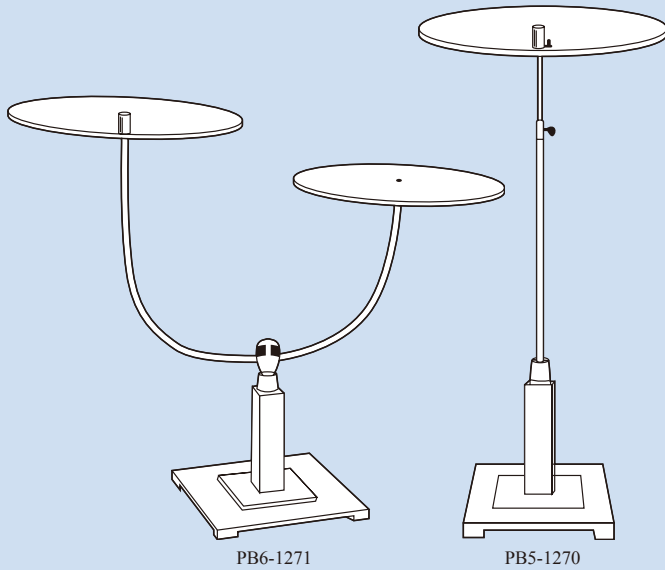

PB6-1271
Double lucite shelves, 8" diameter, 6" base.

PB5-1270
Single Lucite shelf, 8" diameter, 5" base, adjustable height 3/8" x 12/24", extention.

SHOE DISPLAYERS

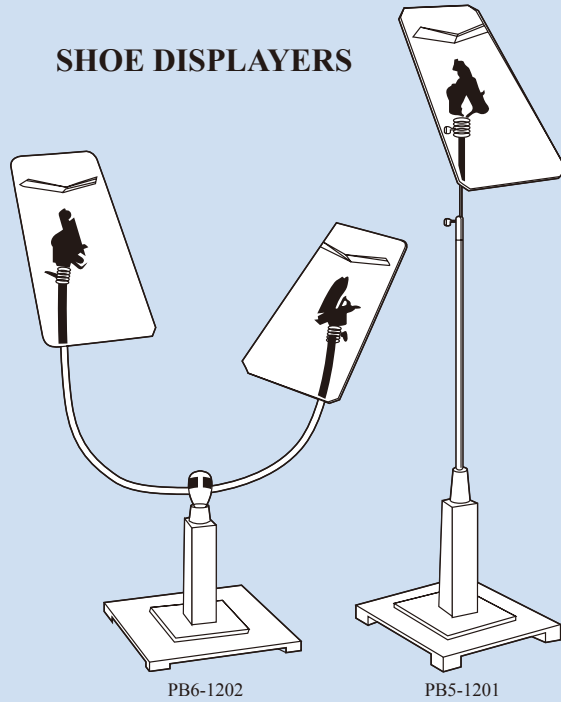

PB6-1202
Double lucite shoe platforms with tilt fitting, 6" base.

PB5-1201
Single shoe stand, lucite platform with tilt fitting, 5" base, adjustable height 3/8" x 12/24" extention.

SHIRT DISPLAYERS

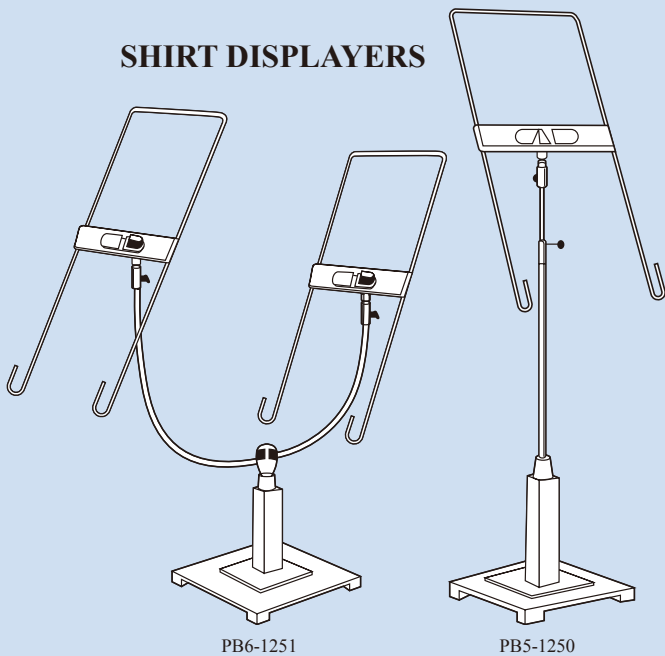

PB6-1251
Double shirt easels with tilt fitting, 6" base.

PB5-1250
Single shirt easel, with tilt fitting, 5" base, adjustable height 3/8" x 12/24" extention.

STANDS

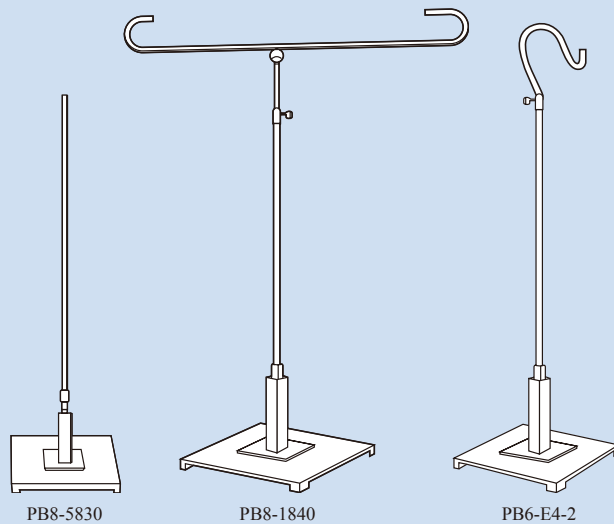

PB8-5830 Form stand, 8" base, 5/8" x 30" upright

PB8-1840 Tee stand, 8" base, 5/8" x 18/36" extention, 23" wide.

PB6-E4-2 Hook stand, 6" base, 5/8" x 18/36" extention.

SQUARE BASE DISPLAY FIXTURES

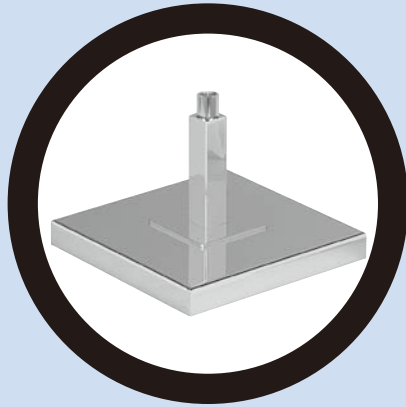

SQUARE BASE

- SB5** – 5" Base
- SB6** – 6" Base
- SB8** – 8" Base
- SB10** – 10" Base

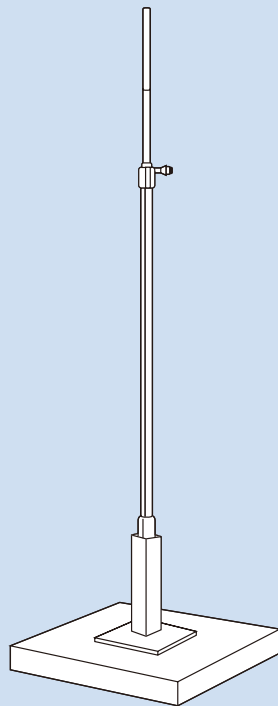

SQUARE BASE

- SB5-3809** – 5" Base, 3/8" × 9" × 18" upright
- SB5-3812** – 5" Base, 3/8" × 12" × 24" upright
- SB5-3815** – 5" Base, 3/8" × 15" × 30" upright
- SB5-3818** – 5" Base, 3/8" × 18" × 36" upright

- SB6-5818** – 6" Base, 5/8" × 18" × 36" upright
- SB6-5824** – 6" Base, 5/8" × 24" × 48" upright
- SB6-5836** – 6" Base, 5/8" × 36" × 72" upright

- SB8-5818** – 8" Base, 5/8" × 18" × 36" upright
- SB8-5824** – 8" Base, 5/8" × 24" × 48" upright
- SB8-5836** – 8" Base, 5/8" × 36" × 72" upright



SQUARE BASE DISPLAY FIXTURES

WATERFALL DISPLAYERS

BLOUSE DISPLAYERS

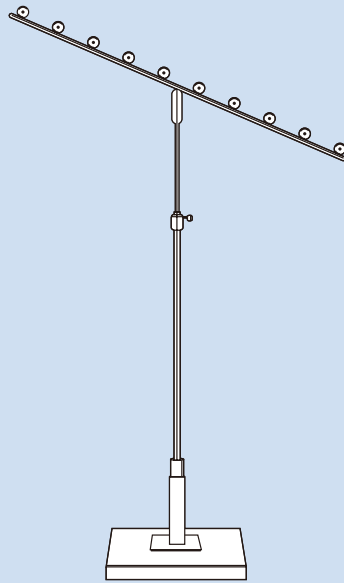
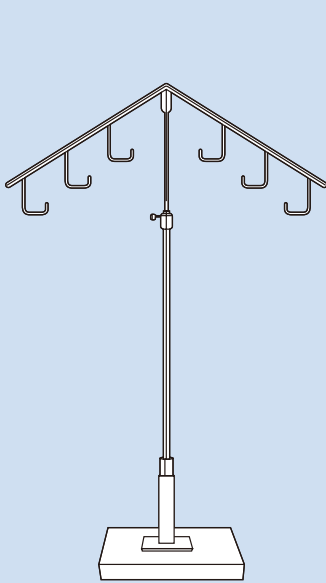

SB8-1826
Tent style, 6 hooks,
8" base, 5/8" x 18/36" extension.

SB8-1820
Single slant, 10 balls,
8" base, 5/8" x 18/36" extension.

SB6-E4-3
Adjustable gooseneck
with waist cincher, 6" base, 5/8" x
18/36" extension, 16" hanger.

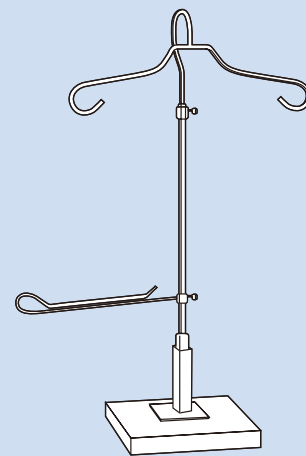

SB8-1821
Single slant, 6 hooks,
8" base, 5/8" x 18/36" extension.

SB8-1825
Tent style, 10 balls,
8" base, 5/8" x 18/36" extension.

SB8-1816
Adjustable gooseneck
with 11" skirt or slack arm, 8" base,
5/8" x 18/36" extension, 16" hanger.

SQUARE BASE DISPLAY FIXTURES



JEWELRY DISPLAYERS

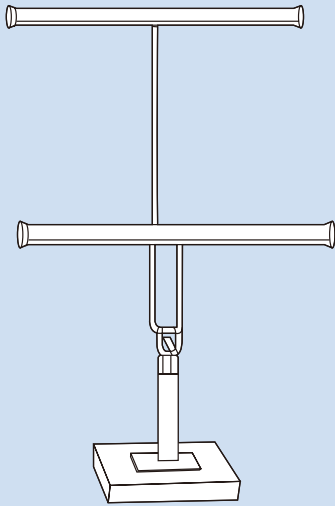

SB6-1830
Necklace and bracelet stand.
6" base, 15" round lucite bars.

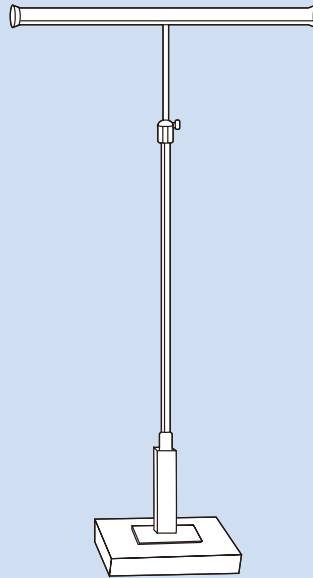

SB6-1832
Rope stand, 6" base, adjustable
5/8" × 18/36" extension,
15" round lucite bar.

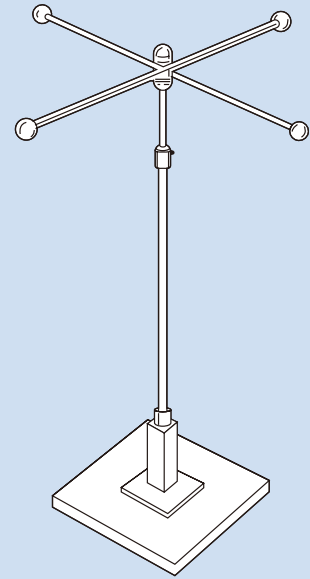

SB8-1834
Revolving rope stand, 8" base,
adjustable 5/8" × 18/36" extension,
1 1/2" diameter, 4 arms on ball
bearing fitting.

MIRROR



SB6-E4-1
Oval double face,
with tilt fitting,
10" × 14", 6" base.

REVOLVING DISPLAYERS

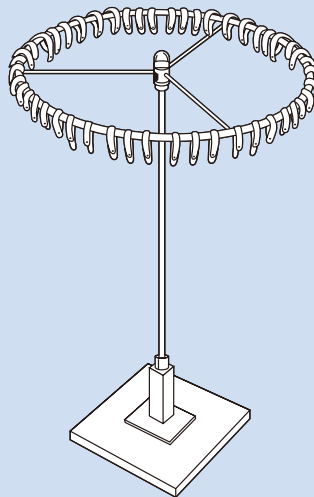

SB8-3010
Scarf stand, 8" base, 5/8" × 18/36"
extension, 14" diameter, ball
bearing fitting- not including 100
plastic clips.



SB10-3012
Tie stand, 10" base,
5/8" × 31" upright, 17" diameter,
ball bearing fitting, 12 spokes
for hook riders.



SQUARE BASE DISPLAY FIXTURES

SHELF STANDS

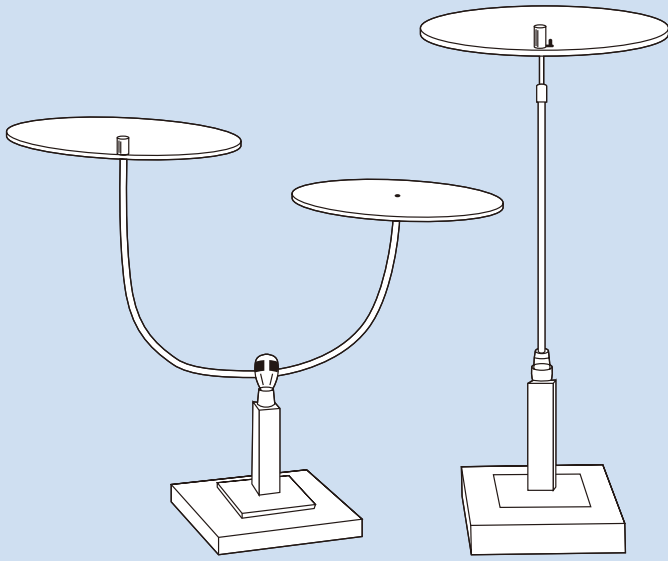

SB6-1271

SB5-1270

SB6-1271

Double lucite shelves, 8" diameter, 6" base.

SB5-1270

Single lucite shelf, 8" diameter, 5" base, adjustable height 3/8" x 12/24" extention.

SHOE DISPLAYERS

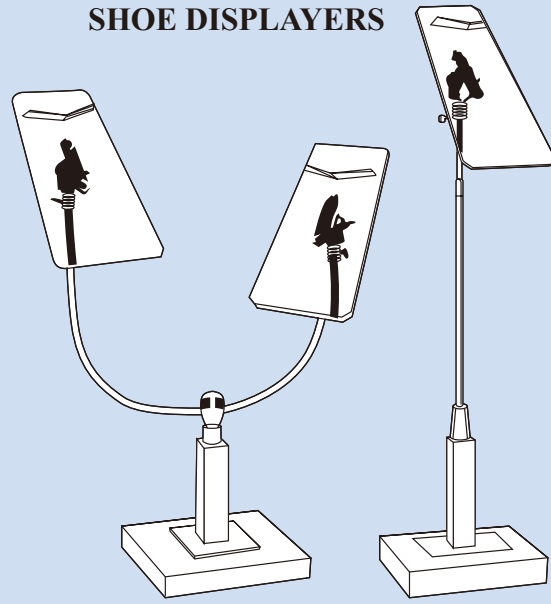

SB6-1202

SB5-1201

SB6-1202

Double lucite shoe platforms with tilt fitting, 6" base.

SB5-1201

Single shoe stand, lucite platform with tilt fitting, 5" base, adjustable height 3/8" x 12/24" extention.

SHIRT DISPLAYERS

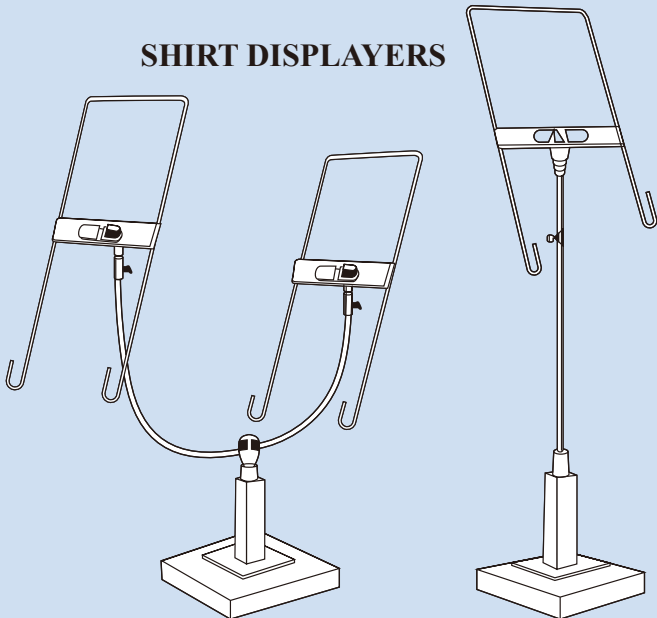

SB6-1251

SB5-1250

SB6-1251

Double shirt easels with tilt fitting, 6" base.

SB5-1250

Single shirt easels, with tilt fitting, 5" base, adjustable height 3/8" x 12/24" extention.

STANDS

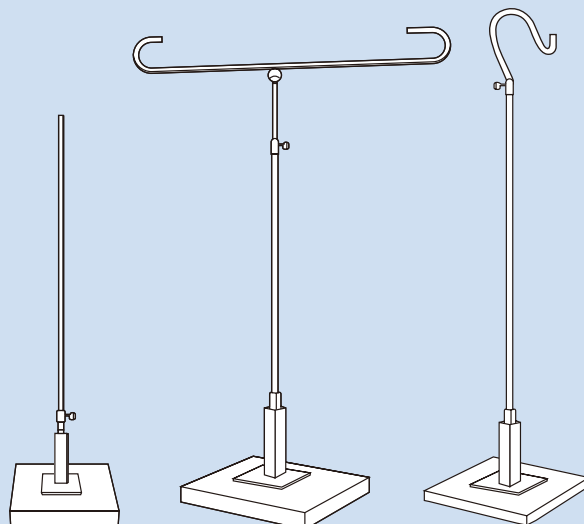

SB8-5830

SB8-1840

SB6-E4-2

SB8-5830 Form stand, 8" base, 5/8" x 30" upright

SB8-1840 Tee stand, 8" base, 5/8" x 18/36" extention, 23" wide.

SB6-E4-2 Hook stand, 6" base, 5/8" x 18/36" extention.

TRUMPET BASE DISPLAY FIXTURES



TRUMPET BASE

- TRB5** – 5" Base
- TRB6** – 6" Base
- TRB8** – 8" Base
- TRB10** – 10" Base

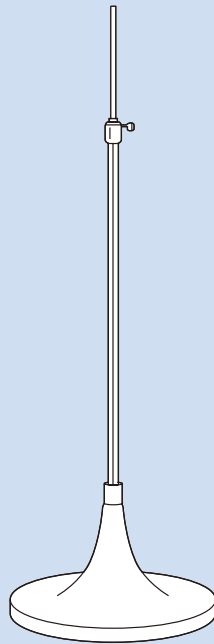

TRUMPET BASE

- TRB5-3809** – 5" Base, 3/8" × 9" × 18" upright
- TRB5-3812** – 5" Base, 3/8" × 12" × 24" upright
- TRB5-3815** – 5" Base, 3/8" × 15" × 30" upright
- TRB5-3818** – 5" Base, 3/8" × 18" × 36" upright

- TRB6-5818** – 6" Base, 5/8" × 18" × 36" upright
- TRB6-5824** – 6" Base, 5/8" × 24" × 48" upright
- TRB6-5836** – 6" Base, 5/8" × 36" × 72" upright

- TRB8-5818** – 8" Base, 5/8" × 18" × 36" upright
- TRB8-5824** – 8" Base, 5/8" × 24" × 48" upright
- TRB8-5836** – 8" Base, 5/8" × 36" × 72" upright



TRUMPET BASE DISPLAY FIXTURES

WATERFALL DISPLAYERS



TRB8-1825
Tent style, 10 balls, 8" base,
5/8" × 18/36" extension.



TRB8-1821
Single slant, 6 hooks, 8" base,
5/8" × 18/36" extension.

BLOUSE DISPLAYERS



TRB6-E4-3
Adjustable gooseneck
with waist cincher, 6" base, 5/8" ×
18/36" extension, 16" hanger.

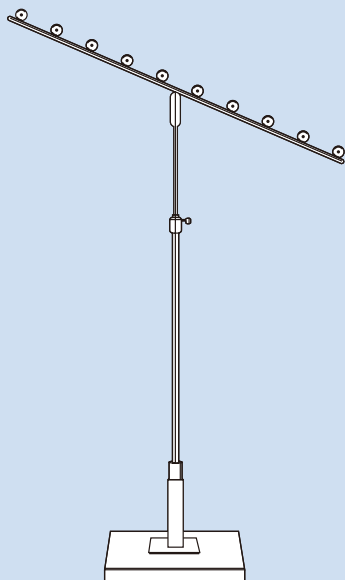

TRB8-1820
Single slant, 10 balls, 8" base,
5/8" × 18/36" extension.

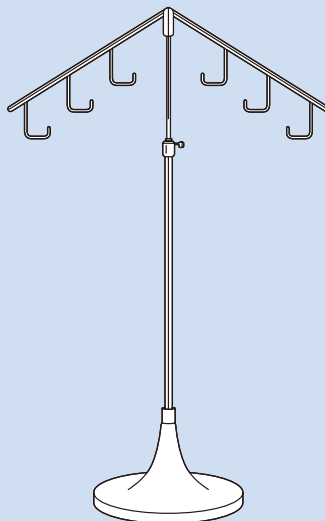

TRB8-1826
Tent style, 6 hooks, 8" base,
5/8" × 18/36" extension.

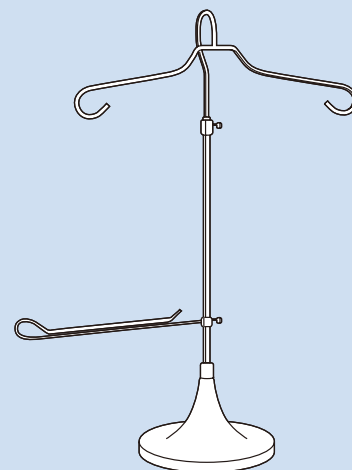

TRB8-1816
Adjustable gooseneck
with 11" skirt or slack arm, 8" base,
5/8" × 18/36" extension, 16" hanger.

TRUMPET BASE DISPLAY FIXTURES



JEWELRY DISPLAYERS

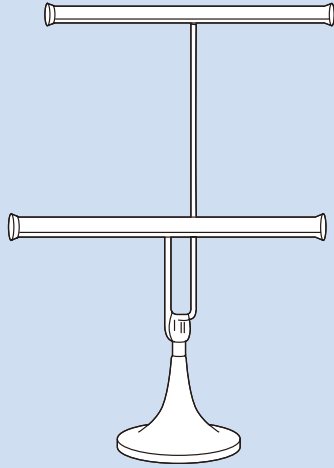

TRB6-1830
Necklace and bracelet stand.
6" base, 15" round lucite bars.

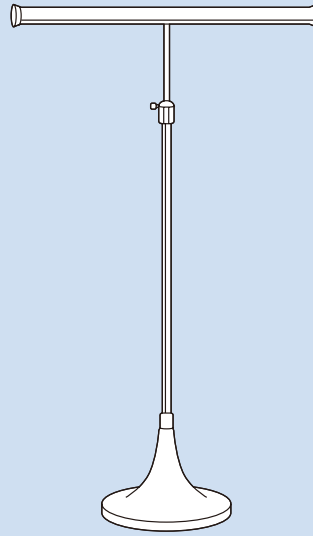

TRB6-1832
Rope stand, 6" base, adjustable
5/8" x 18/36" extension,
15" round lucite bar.

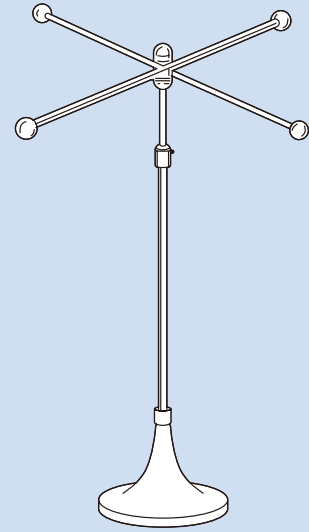

TRB8-1834
Revolving rope stand, 8" base,
adjustable 5/8" x 18/36" extension,
1 1/2" diameter, 4 arms on ball
bearing fitting.

MIRROR



TRB6-E4-1
Oval double face,
with tilt fitting,
10" x 14", 6" base.

REVOLVING DISPLAYERS

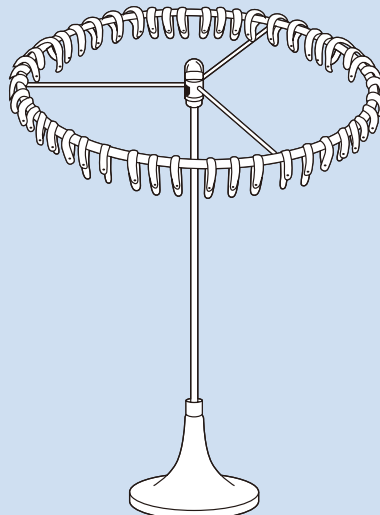

TRB8-3010
Scarf stand, 8" base, 5/8" x 18/36"
extension, 14" diameter, ball
bearing fitting- not including 100
plastic clips.

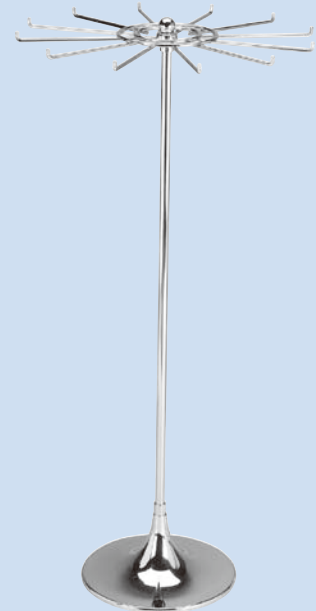

TRB10-3012
Tie stand, 10" base, 5/8" x 31"
upright, 17" diameter, ball bearing
fitting, 12 spokes for hook riders.



TRUMPET BASE DISPLAY FIXTURES

SHELF STANDS

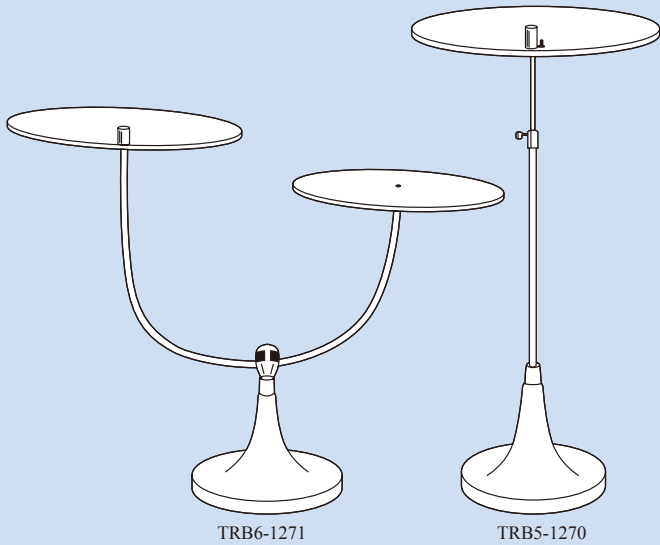

TRB6-1271

TRB5-1270

TRB6-1271

Double lucite shelves, 8" diameter, 6" base.

TRB5-1270

Single Lucite shelf, 8" diameter, 5" base, adjustable height 3/8" x 12/24" extention.

SHOE DISPLAYERS

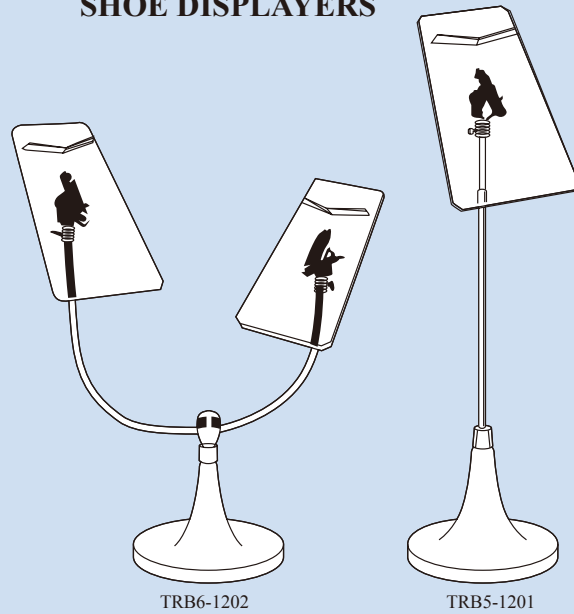

TRB6-1202

TRB5-1201

TRB6-1202

Double lucite shoe platforms with tilt fitting, 6" base.

TRB5-1201

Single shoe stand, lucite platform with tilt fitting, 5" base, adjustable height 3/8" x 12/24" extention.

SHIRT DISPLAYERS



TRB6-1251

TRB5-1250

TRB8-5830

TRB6-1251

Double shirt easels with tilt fitting, 6" base.

TRB5-1250

Single shirt easels, with tilt fitting, 5" base, adjustable height 3/8" x 12/24" extention.

STANDS

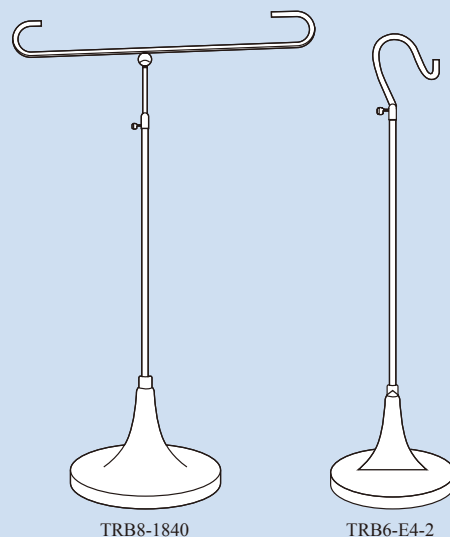

TRB8-1840

TRB6-E4-2

TRB8-5830

Form stand, 8" base, 5/8" x 30" upright

TRB8-1840

Tee stand, 8" base, 5/8" x 18/36" extention, 23" wide.

TRB6-E4-2

Hook stand, 6" base, 5/8" x 18/36" extention.

TRUMPET BASE DISPLAY FIXTURES

COUNTER FIXTURE PARTS



STYLE NUMBER	DESCRIPTION
E4-1	Oval Mirror, Double Face
1201	Single Shoe Stand
1202	Double Shoe Stand
1250	Single Shirt Easel
1251	Double Shirt Easel
1270	Single Shelf Stand
1271	Double Shelf Stand
E4-2	Hook Stand
E4-3	Gooseneck Blouse Displayer with Waist Cincher
1816	Gooseneck Blouse Displayer with Skirt or Slack Arm
1820	Single Slant Displayer-10 Balls
1821	Single Slant Displayer-6 Hooks
1825	Tent Displayer-10 Balls
1826	Tent Displayer-6 Hooks
1830	Necklace and Bracelet Stand
1832	Rope Stand
1834	Revolving Rope Stand
1840	Tee Stand
3010	Revolving Scarf Stand, not including 100 plastic clips
3012	Revolving Tie Stand
* 3809	Deluxe 3/8" × 6" × 12" Upright
* 3812	Deluxe 3/8" × 9" × 18" Upright
* 3815	Deluxe 3/8" × 12" × 24" Upright
* 3818	Deluxe 3/8" × 15" × 30" Upright
* 5818	Deluxe 5/8" × 15" × 30" Upright
* 5824	Deluxe 5/8" × 21" × 42" Upright
* 5830	Form Stand, 5/8" × 30" Upright
* 5836	Deluxe 5/8" × 33" × 66" Upright
* 7836	Dress Form Upright, 7/8" × 36"
WC	Waist Cincher for 1816 & E4-3
SA	Slack Arm

* Deluxe uprights, when used with our square, parsons or trumpet bases, will be 3" higher over-all.



COUNTERTOP FLEXIBLE SHOULDER STAND

21" long black flexible shoulder form

7" dia. chrome base

Adj. height 17" to 28"

902

F



DISPLAYERS

CHAPTER	DIVISION	CONTENTS
F	01	JEWELRY DISPLAYER
	02	GLASSES DISPLAYER



NECKLACE JEWELRY-BUST
Oval shape 8" x 7½"
NJDB-OVAL



NECKLACE JEWELRY-BUST
Round shape 7½" dia.
NJDB-RD

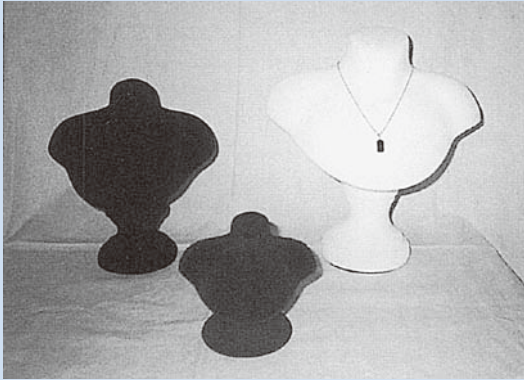

NECKLACE JEWELRY DISPLAY FORM
PE Form, covered with Black/White Velvet.
NJDF-L 11" H
NJDF-M 8" H
NJDF-S 4" H

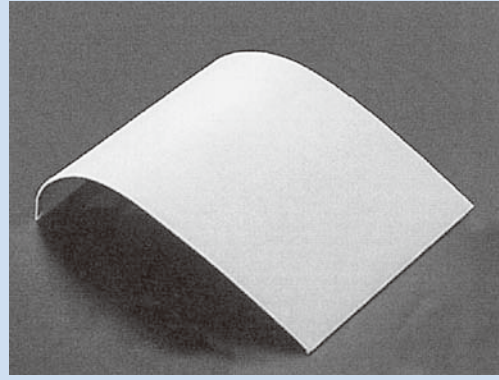

NECKLACE JEWELRY DISPLAY PAD
Multiple 12" L x 8½" W
NJDP-MULTI

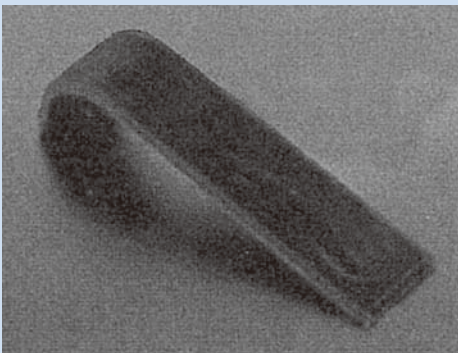

NECKLACE JEWELRY DISPLAY PAD
Single 8½" L x 2" W
NJDP-SGL

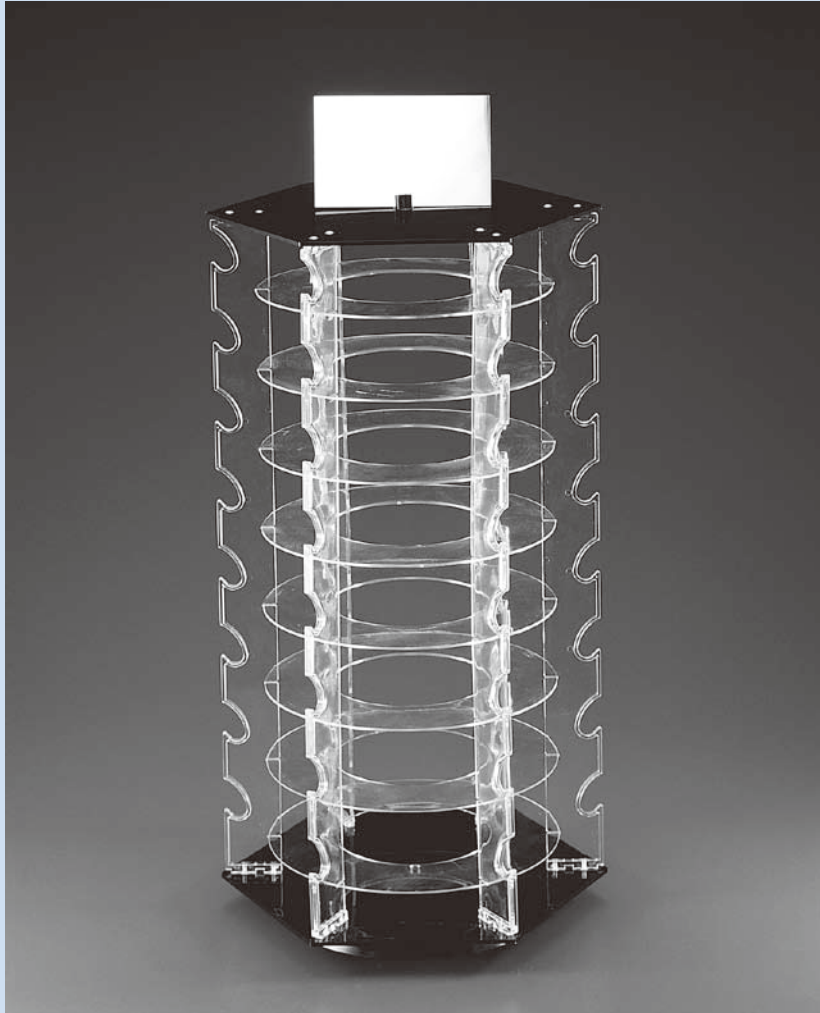

ACRYLIC EYE GLASSES DISPLAYER

With black swivel base and mirror

R-24B For 24 Eye Glasses

R-36B For 36 Eye Glasses

R-48B For 48 Eye Glasses

G



GONDOLAS & DIVIDERS

CHAPTER	DIVISION	CONTENTS
G	01	GONDOLAS
	02	ACCESSORIES

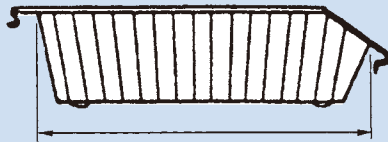
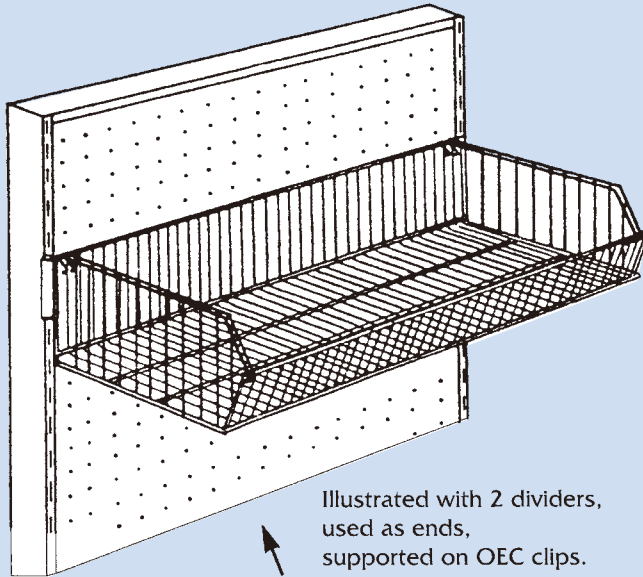

Available depths same as baskets

OPEN END BASKETS

Chrome

Item #	Size
# OEB 1048	10" × 48"
# OEB 1248	12" × 48"
# OEB 1448	14" × 48"
# OEB 1648	16" × 48"

BASKET DIVIDERS

Chrome

Item #	Size
# OED 10	10"
# OED 12	12"
# OED 14	14"
# OED 16	16"

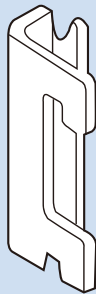

HANGING CLIPS

When using baskets without shelves, clips for hanging are available.

2" Long, Chrome

OEC-L LEFT

OEC-R RIGHT

H

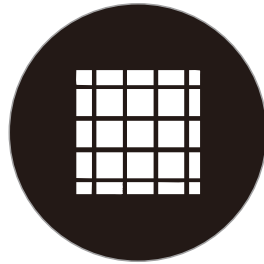

GRIDWALL

CHAPTER	DIVISION	CONTENTS
H	01	GRIDWALL
	02	METAL ACCESSORIES
	03	ACRYLIC ACCESSORIES
	04	BINS & MERCHANDISERS
	05	SECURITY CART

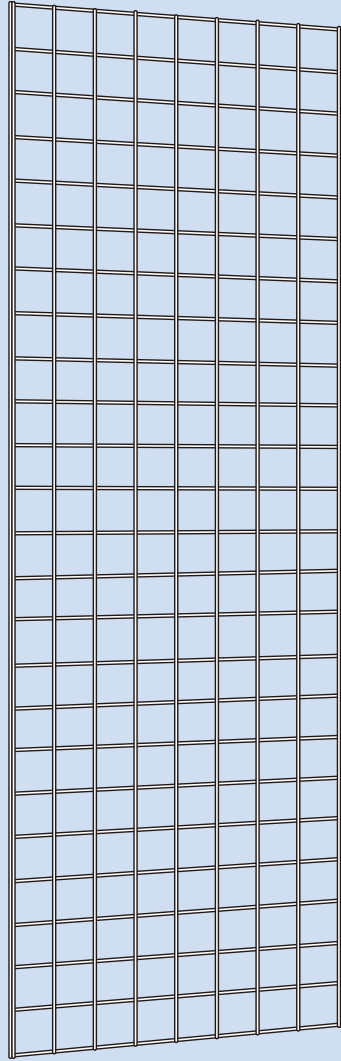

Grid Wall Panels

6mm Wire - 3" Grid

Vertical sides have double wire

Chrome Plated	Brass Plated	White Epoxy	Black Epoxy	Sizes (W × H)
GW15	GW15BR	GW15W	GW15B	1' × 5'
GW24	GW24BR	GW24W	GW24B	2' × 4'
GW25	GW25BR	GW25W	GW25B	2' × 5'
GW26	GW26BR	GW26W	GW26B	2' × 6'
GW27	GW27BR	GW27W	GW27B	2' × 7'
GW28	GW28BR	GW28W	GW28B	2' × 8'
GW36	GW36BR	GW36W	GW36B	3' × 6'
GW37	GW37BR	GW37W	GW37B	3' × 7'
GW38	GW38BR	GW38W	GW38B	3' × 8'
GW44		GW44W	GW44B	4' × 4'
GW48		GW48W	GW48B	4' × 8'
GWTW5		GWTW5W	GWTW5B	2' × 5' with triple center wire

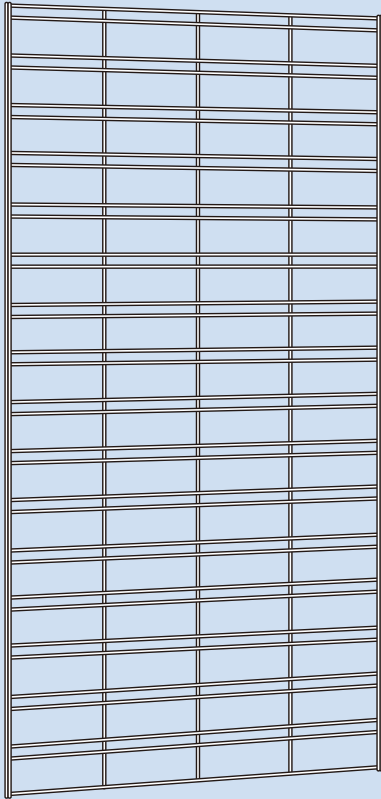

SLATGRID

Sturdy 6mm dia. wires. Vertical wires are spaced approximately 6" O.C. Horizontal wires are spaced 5/8" O.C. then 2-3/8" O.C. Double vertical end wires for added support. Panels are 24" wide. Accepts slatwall and gridwall display hardware.

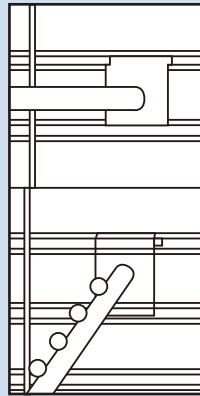

Chrome Plated	Brass Plated	White Epoxy	Black Epoxy	Sizes
SG24	SG24BR	SG24W	SG24B	2' x 4'
SG25	SG25BR	SG25W	SG25B	2' x 5'
SG26	SG26BR	SG26W	SG26B	2' x 6'
SG27	SG27BR	SG27W	SG27B	2' x 7'
SG28	SG28BR	SG28W	SG28B	2' x 8'

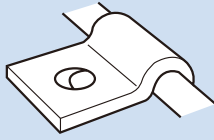

Flush Mounting Clip

For securing panels to desired locations on floor.

- # **GW1** Chrome
- # **GW1B** Black
- # **GW1W** White

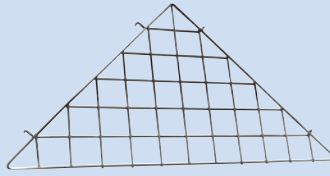

Triangular Shelf

24" x 24"

- # **GW5** Chrome
- # **GW5B** Black
- # **GW5W** White

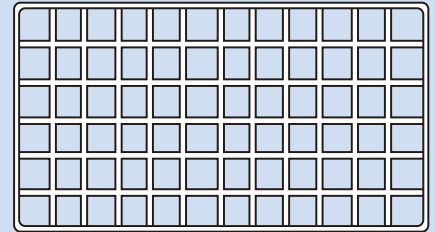
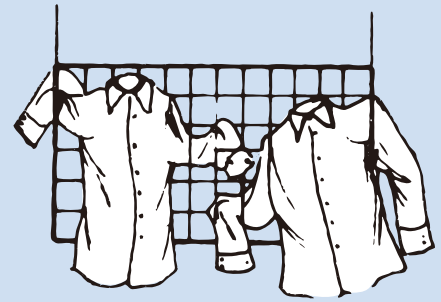

Chrome Light Weight Display Grid

3/16" Wire. 4" squares.

Ideal for hanging from ceiling or in windows.

- # **GW24L** 2' x 4'



Joining Clip

Joins grids for straight or angle positions.

- # **GW2** Zinc Plated
- # **GW2B** Black
- # **GW2W** White

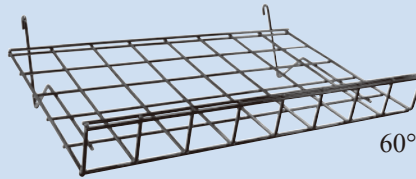

Slant Shelf With Lip

15" x 24"

- # **GW6** Chrome
- # **GW6B** Black
- # **GW6W** White

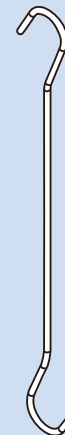

Ceiling Hooks

For displaying grid from ceilings

- # **GWC6** 6"L
- # **GWC12** 12"L
- # **GWC18** 18"L
- # **GWC24** 24"L
- # **GWC30** 30"L
- # **GWC36** 36"L
- # **GWC48** 48"L
- # **GWC60** 60"L



2" Wall Bracket

- # **GW3** Chrome
- # **GW3B** Black
- # **GW3W** White

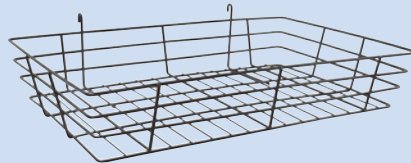

Basket

15" x 24" x 4"H

- # **GW7** Chrome
- # **GW7BLK** Black
- # **GW7W** White

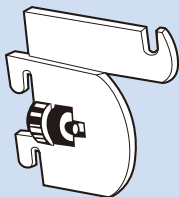

2" Slotted Standard Bracket

1/2" slots on 1" centers

- # **GW4** Chrome
- # **GW4B** Black
- # **GW4W** White

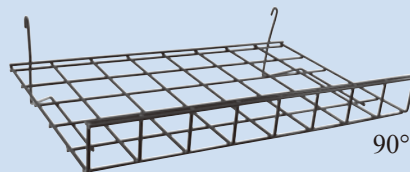

Straight Shelf with Lip

15" x 24"

- # **GW8** Chrome
- # **GW8B** Black
- # **GW8W** White

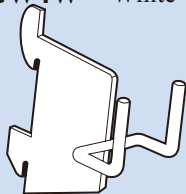

Heavy Duty Grid Bracket

For 1" slots on 2" centers

- # **GW4R** Chrome

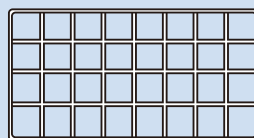

Grid Shelf Chrome

- # **GW124** 12" x 24"
- # **GW148** 12" x 48"

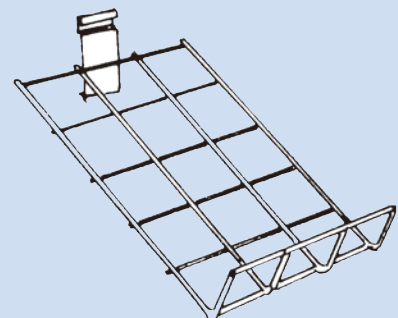

Chrome Shirt Easel

9" x 15"

- # **GW915S**

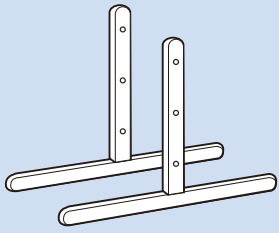

Economy 'T' Legs

Constructed of two 3/16" x 1" steel bars, with three nuts and bolts to assure stability. Chrome.

AS1601 24-1/2" W x 17-1/2" H

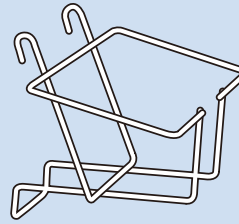

Gridwall Hosiery Bin

8" wide x 5-3/4" deep x 4-1/2" high, chrome

GWPH



Ball Holder

Chrome.

GWBH 9 1/2" Dia

GWFH 6" Dia

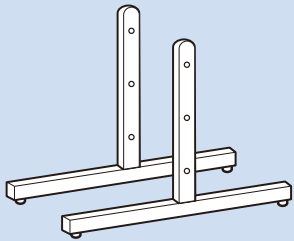

Deluxe 'T' Legs

Constructed of 3/16"x1" vertical steel bar and a 1/2"x1 1/2" horizontal tube with two adjustable levelers to prevent panel from rocking. Three nuts and bolts to assure stability.

AS1611 24" W x 18-1/2" H Chrome

AS1611-B 24" W x 18-1/2" H Black

AS1611-W 24" W x 18-1/2" H White

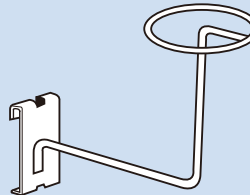

Hat Holder

4-1/2" high x 8" deep 3" ring

GWHH Chrome

GWHH-B Black

GWHH-W White

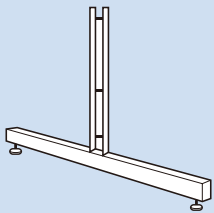

Super Duty 'T' Legs

Constructed of 3/8"x1" channeled upright, and a 1/2"x1-1/2" horizontal tube. Two adjustable levelers prevent panel from rocking. Three bolts and nuts to assure stability. Chrome.

AS1621

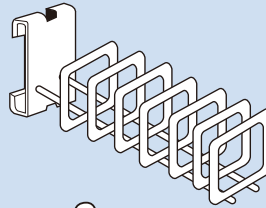

Chrome Clutch Bag

6 Holder, 12" L, Chrome.

GWCB

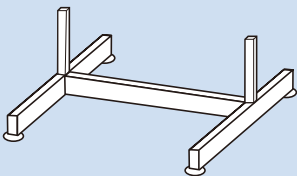

Deluxe Grid Base

Constructed of 1"x2" tubing with horizontal bar for rigidity and strength. Uses 24"x24" floor space, Chrome.

AS1631

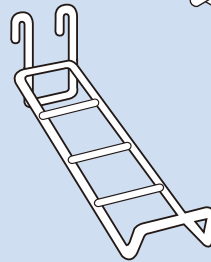

Chrome Shoe Displayer

Front Profile Illustrated

GW410R Right profile

GW410L Left profile

GW410F Front View



Deluxe 'L' Legs

Constructed of 3/16"x1" vertical steel bar and a 1/2"x1-1/2" horizontal tube with two adjustable levelers to prevent panel from rocking.

Three nuts and bolts to assure stability.

AS1641 12" W x 19" H Chrome

AS1641-B 12" W x 19" H Black

AS1641-W 12" W x 19" H White

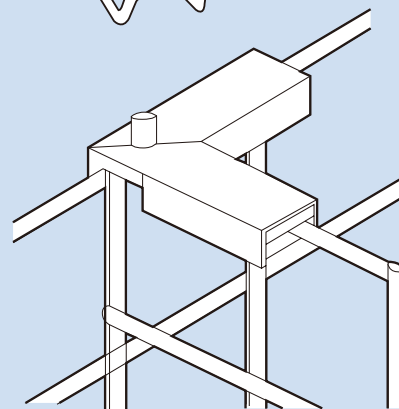

Magnetic sign holder for grid

3"x3", Chrome

MSH33

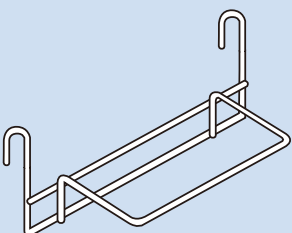

Wire Shoe Shelf

3"x6" Great for sneakers & shoes

WSS36 Chrome

WSS36B Black epoxy

WSS36W White epoxy

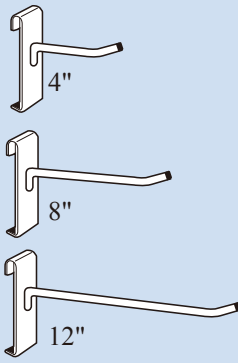

Chrome Gridwall Hooks

- # GWH1 1"L
- # GWH2 2"L
- # GWH4 4"L
- # GWH6 6"L
- # GWH8 8"L
- # GWH10 10"L
- # GWH12 12"L

- | | |
|--------------|--------------|
| Black | White |
| # GWH1B | # GWH1W |
| # GWH2B | # GWH2W |
| # GWH4B | # GWH4W |
| # GWH6B | # GWH6W |
| # GWH8B | # GWH8W |
| # GWH10B | # GWH10W |
| # GWH12B | # GWH12W |

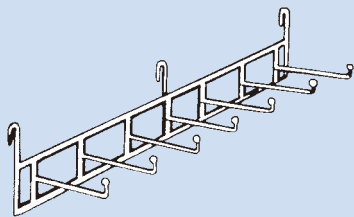

Belt & Tie Displayer

20" wide, 7-6" Chrome spokes for hanging.

GW7HD

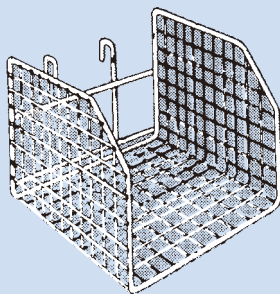

All Wire Shirt And Sweater Bin

One piece construction made in 1" grid pattern, 16" Deep x 10" wide x 8" high.

- # WS708C Chrome
- # WS708B Black
- # WS708W White

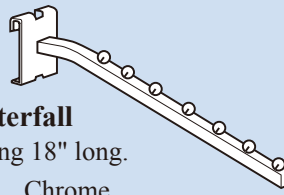

7 Ball Waterfall

Square tubing 18" long.

- # GW7B Chrome
- # GWB7B Black
- # GWW7B White

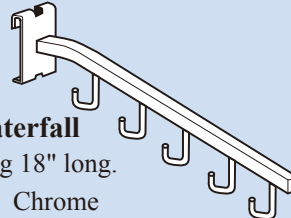

5 Hook Waterfall

Square tubing 18" long.

- # GW5H Chrome
- # GWB5H Black
- # GWW5H White

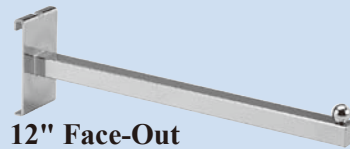

12" Face-Out

Square tubing

- # GW12 Chrome
- # GWB12 Black
- # GWW12 White

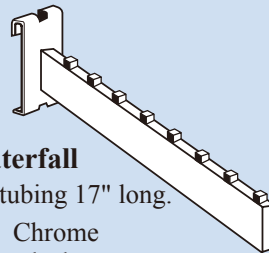

8 Cube Waterfall

Rectangular tubing 17" long.

- # RG8C Chrome
- # RG8C-B Black
- # RG8C-W White

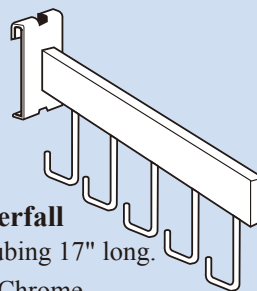

5 Hook Waterfall

Rectangular tubing 17" long.

- # RG5H Chrome
- # RG5H-B Black
- # RG5H-W White



12" Face-Out

Rectangular tubing.

- # RG12 Chrome
- # RG12B Black
- # RG12W White



Knife Shelf Bracket Chrome

- # GW8KB 8"
- # GW10KB 10"
- # GW12KB 12"
- # GW14KB 14"



Adjustable Shelf Bracket Chrome

- # GW10ADJ 10" Long
- # GW12ADJ 12" Long
- # GW14ADJ 14" Long



Hangrail Bracket

12" Long, Chrome

- # GWRT Holds 1-1/4" O.D. Tubing
- # GWRM Holds 1" & 1-1/16" O.D. Tubing



Hangrail Bracket

For 1/2" x 1-1/2" rect. tubing, 12" Long

- # GW12RT Chrome
- # GW12RT-B Black
- # GW12RT-W White

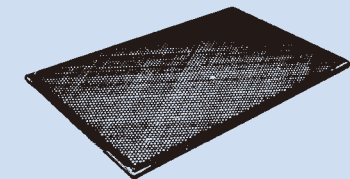

Perforated Metal Shelf

23"x15", Bullnose front.

Fits on two 14" epoxy shelf brackets.

- # ES5B Black
- # ES5W White

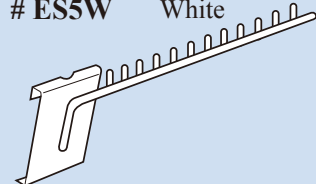

Upswing Waterfall

8 1/2 L. with 12 pegs, Chrome.

UW-8



GRIDWALL SCARECROWS

Adjustable from 18" to 28" to 35"

- # **GWSC** Chrome
- # **GWSC-B** Black
- # **GWSC-W** White

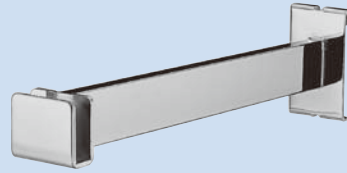

GRIDWALL HANGRAIL BRACKETS

Holds 1/2" × 1-1/2" rectangular hangrail
Made of 1/2" × 1-1/2" rectangular tube,
12" long

- # **GW12RTR** Chrome
- # **GW12RTR-B** Black
- # **GW12RTR-W** White

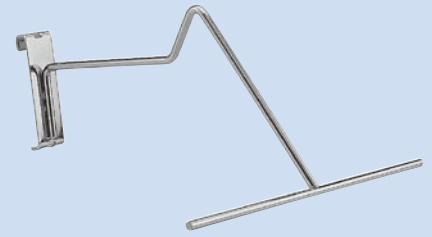

GRIDWALL WESTERN HAT DISPLAY

9-3/4" × 9-1/2" × 6"

- # **GWHB** Chrome

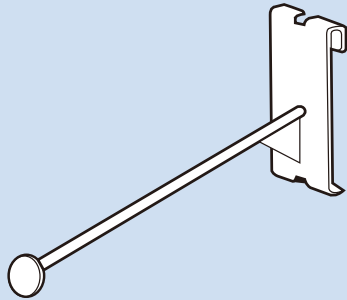

STRAIGHT OUT

3/8" dia rod, 15" long

- # **SO-15G** Chrome



ROUND TUBING FACEOUT

5/8" dia. with disk end
12" long

- # **GW11** Chrome
- # **GW11-B** Black
- # **GW11-W** White



UTILITY HOOK

Extends 1/2" Ideal for hanging pictures or single hangers

- # **GWH** Chrome
- # **GWH-B** Black
- # **GWH-W** White



BALL HOLDER

5" dia. with 4" extension

- # **GBB2-3** Chrome

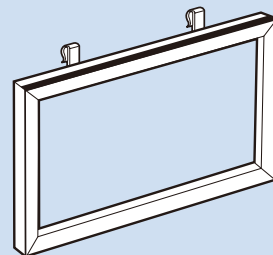

GRIDWALL SIGN HOLDER

Chrome

- # **MGW57** 5 1/2" × 7"
- # **MGW711** 7" × 11"

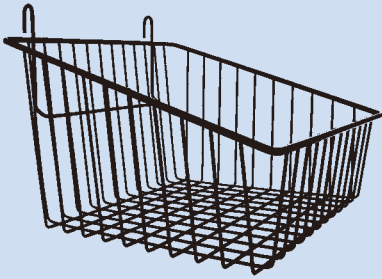

SLOPED FRONT BASKET

12"W × 12"D × 4"H (Front) × 8"H (Rear)

- # H2-1 Chrome
- # H2-1B Black
- # H2-1W White



NARROW BASKET

12"W × 6"D × 6"H

- # GWB 1266 Chrome
- # GWB 1266-B Black
- # GWB 1266-W White

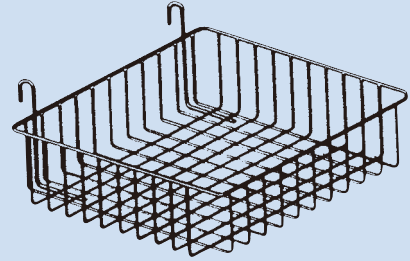

SHALLOW BASKET

12"W × 12"D × 4"H

- # GWB 12124 Chrome
- # GWB 12124-B Black
- # GWB 12124-W White



DEEP BASKET

12"W × 12"D × 8"H

- # GWB 12128 Chrome
- # GWB 12128-B Black
- # GWB 12128-W White

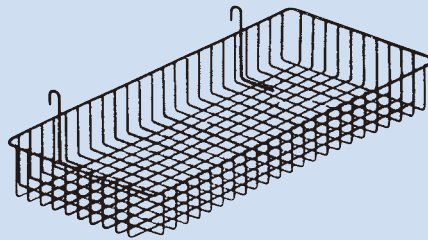

SHALLOW BASKET

24"W × 12"D × 4"H

- # GWB 12244 Chrome
- # GWB 12244-B Black
- # GWB 12244-W White

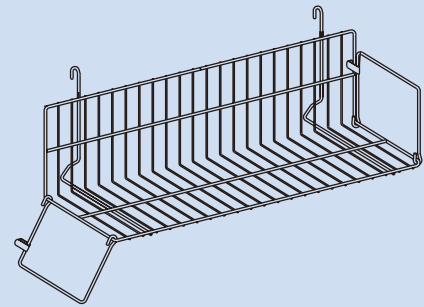

VIDEO/BOOK SHELF

Wire rack has hinged ends to use singly or in a continued run. Tilt back design keeps goods from falling forward, 5³/₄" deep × 6³/₄" high

- | | | |
|------------|------------|----------|
| Black | White | Length |
| # VCS24B-G | # VCS24W-G | 24" wide |
| # VCS48B-G | # VCS48W-G | 48" wide |

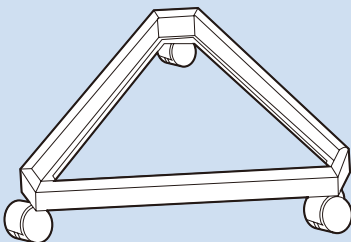

GRID TRIANGLE BASE

Includes casters, Holds three 2' wide grid panels

- # GW3TB Chrome
- # GW3TB-B Black
- # GW3TB-W White

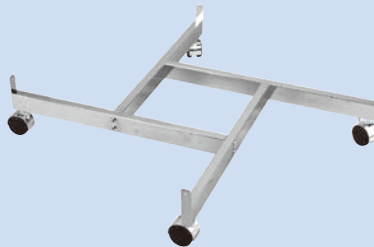

4 WAY GRID BASE

Includes casters, Holds four 2' wide grid panels

- # H2-8 Chrome
- # H2-8B Black
- # H2-8W White

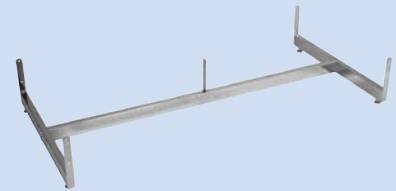

GRID GONDOLA BASE

Hardware to connect base to grid panels are included

- # H2-9 Chrome
- # H2-9B Black
- # H2-9W White

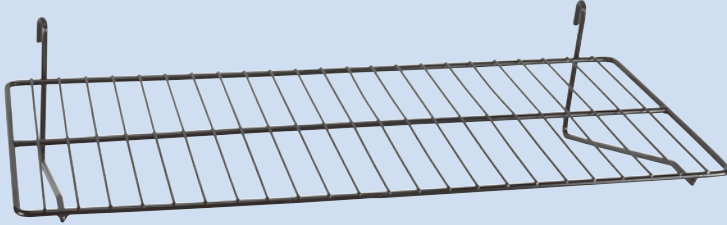

STRAIGHT SHELF

12"D × 24"W

GW9 Chrome

GW9B Black

GW9W White

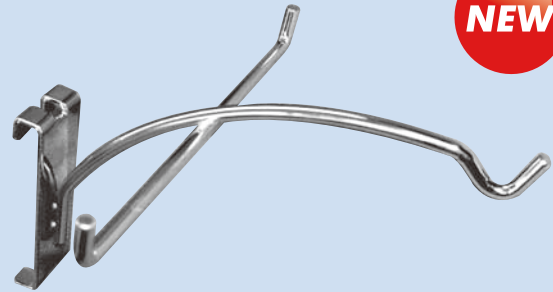

EYEGASSES DISPLAY

5-1/2"D × 5-1/2"W

GWEG Chrome

GWEG-Z Zinc

GWEG-B Black

GWEG-W White

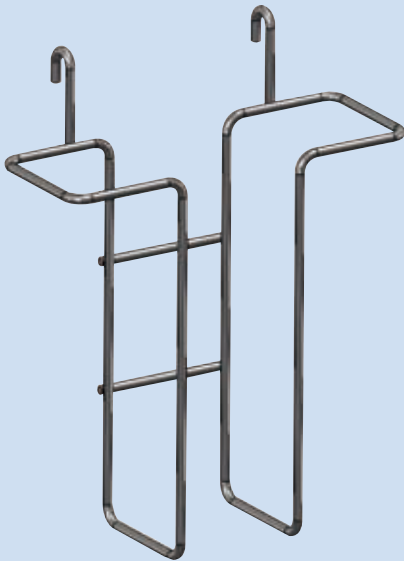

LITERATURE TRAY(Vertical)

9"W × 9"H × 4"D

U2-1 Chrome

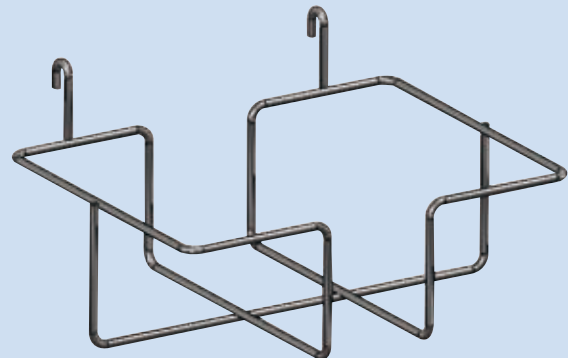

LITERATURE TRAY(Horizontal)

12"W × 4"H × 9"D

U2-2 Chrome

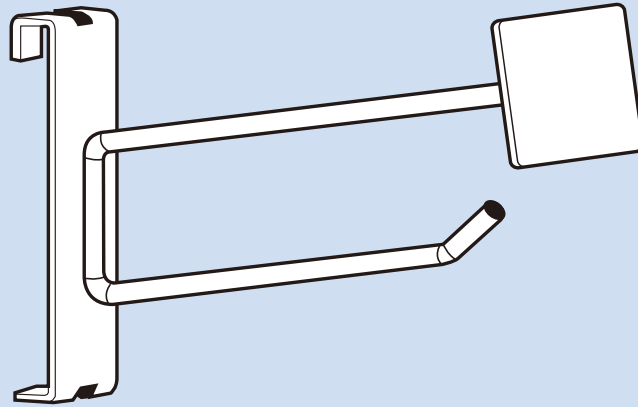

GRIDWALL SCANNER HOOK ZINC

Length	Metal Plate: 1-3/8"×3"×1.5mm Wire Dia. 0.187"	Metal Plate: 1-3/8"×3"×1.5mm Wire Dia. 0.225"	Metal Plate: 1-3/8"×2-1/8"×1.5mm Wire Dia. 0.187"	Metal Plate: 1-3/8"×2-1/8"×1.5mm Wire Dia. 0.225"
4"	M13G4-ME	M13G4-HD	M12G4-ME	M12G4-HD
6"	M13G6-ME	M13G6-HD	M12G6-ME	M12G6-HD
8"	M13G8-ME	M13G8-HD	M12G8-ME	M12G8-HD
10"	M13G10-ME	M13G10-HD	M12G10-ME	M12G10-HD
12"	M13G12-ME	M13G12-HD	M12G12-ME	M12G12-HD

GRIDWALL SCANNER HOOK CHROME

Length	Metal Plate: 1-3/8"×3"×1.5mm Wire Dia. 0.187"	Metal Plate: 1-3/8"×3"×1.5mm Wire Dia. 0.225"	Metal Plate: 1-3/8"×2-1/8"×1.5mm Wire Dia. 0.187"	Metal Plate: 1-3/8"×2-1/8"×1.5mm Wire Dia. 0.225"
4"	M13G4-ME-C	M13G4-HD-C	M12G4-ME-C	M12G4-HD-C
6"	M13G6-ME-C	M13G6-HD-C	M12G6-ME-C	M12G6-HD-C
8"	M13G8-ME-C	M13G8-HD-C	M12G8-ME-C	M12G8-HD-C
10"	M13G10-ME-C	M13G10-HD-C	M12G10-ME-C	M12G10-HD-C
12"	M13G12-ME-C	M13G12-HD-C	M12G12-ME-C	M12G12-HD-C

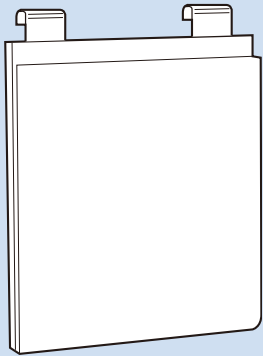

ACRYLIC SIGNHOLDER

Item	H × W
# JD516GW	7" × 5½"
# JD517GW	5½" × 7"
# JD518GW	11" × 7"
# JD519GW	7" × 11"
# JD522GW	14" × 11"
# JD523GW	11" × 14"

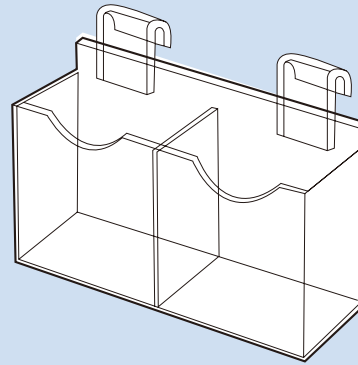

ACRYLIC DOUBLE HOSEIERY BOX

15" Wide × 6½" High × 4½" Deep
SP2047G

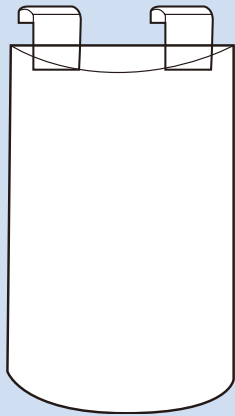

ACRYLIC FASHION BELT DISPLAYER

Half cylinder 19"H × 18"W
SP2018G

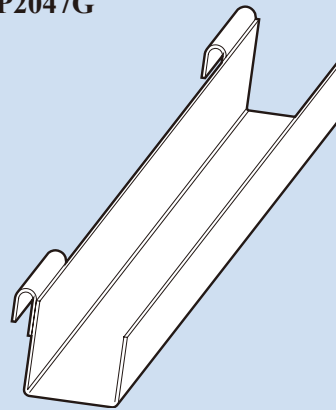

ACRYLIC J-RACK SHELF

2-1/2" front lip, 3-1/2" back.
Depth is 1-3/4" outside, 1-1/2" inside
G2270 11-3/4"L open both ends
G2275 23-3/4"L open both ends
G2291 35-3/4"L open both ends
G2292 47-3/4"L open both ends

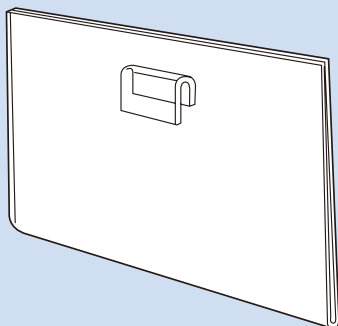

ACRYLIC CARDFRAME

Item	H × W
# GFRAME1	5½" × 7"
# GFRAME2	7" × 11"

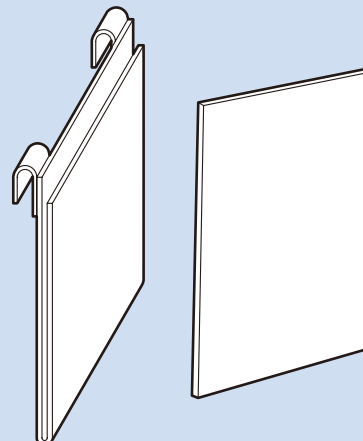

ACRYLIC T-SHIRT DISPLAY

Sleeve 11-1/2"W × 14"H × 1"D
Insert 11-1/4"W × 13-1/2"H
GTSHIRT

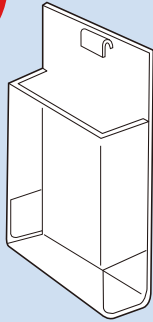

ACRYLIC SINGLE BROCHURE HOLDER

With 2" deep pocket, 1/8" thick.

AC-3111 4"W × 9"H

AC-3115 8-1/2"W × 11"H

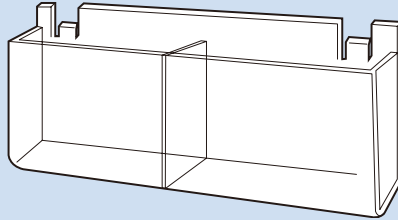

ACRYLIC DOUBLE BROCHURE HOLDER

Holds 8 1/2" × 11" brochure

G3452

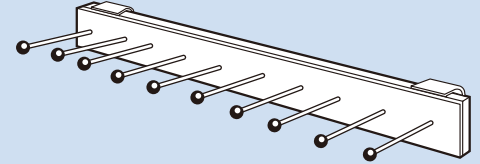

ACRYLIC BELT & TIE DISPLAY

G1979G 20"

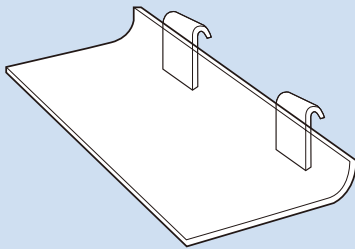

ACRYLIC SHELF

For Gridwall, 1/4" thick.

4"D × 9"W

AC-3001

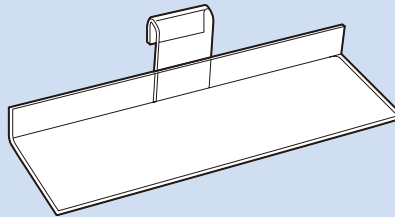

ACRYLIC SHOE SHELF

1/8" thick

JD651GW 3"D × 9"W

JD653GW 4"D × 9"W

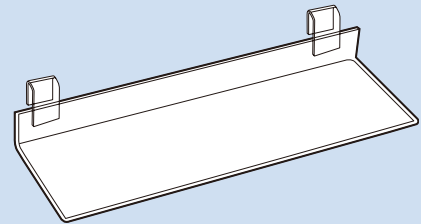

ACRYLIC SHOE SHELF

2.5mm thick

G3001 4"D × 9"W

G3002 4"D × 12"W

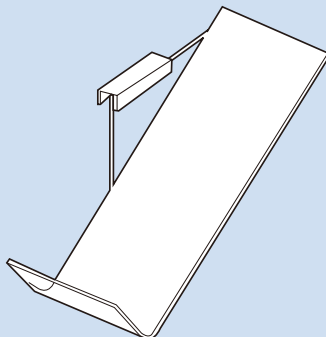

ACRYLIC LEFT SLANT SHOE SHELF

G10L 4"D × 9"W

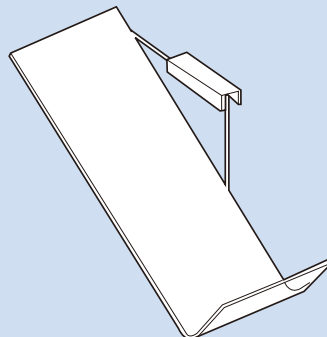

ACRYLIC RIGHT SLANT SHOE SHELF

G10R 4"D × 9"W

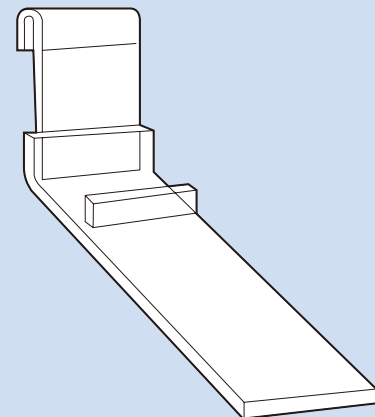

ACRYLIC SHOE SHELF

1972G-3 3"D × 8"W

1972G-4 4"D × 10"W

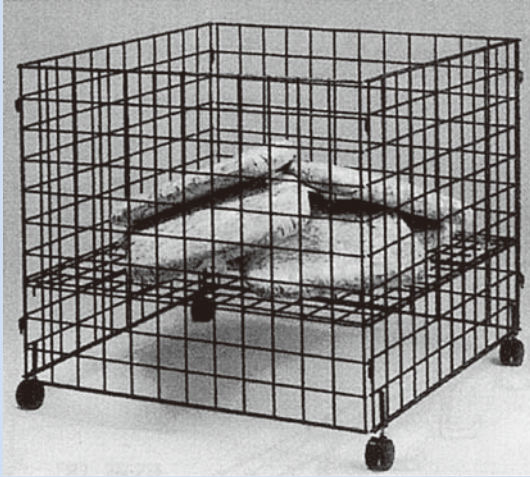

GRID DUMP BINS - HIGH CAPACITY

Ideal for large bulky items. The grid panels ship flat and allow for quick assembly and knockdown for space saving storage. No tools needed! Floor panel adjusts from bottom to top of unit in 3" increments to vary capacity. Constructed of ¼" wire in 3" squares.

30"H X 36" SQ. with 4-pc. casters.

Item	Color
# SB3636W	White
# SB3636B	Black
# SB3636C	Chrome

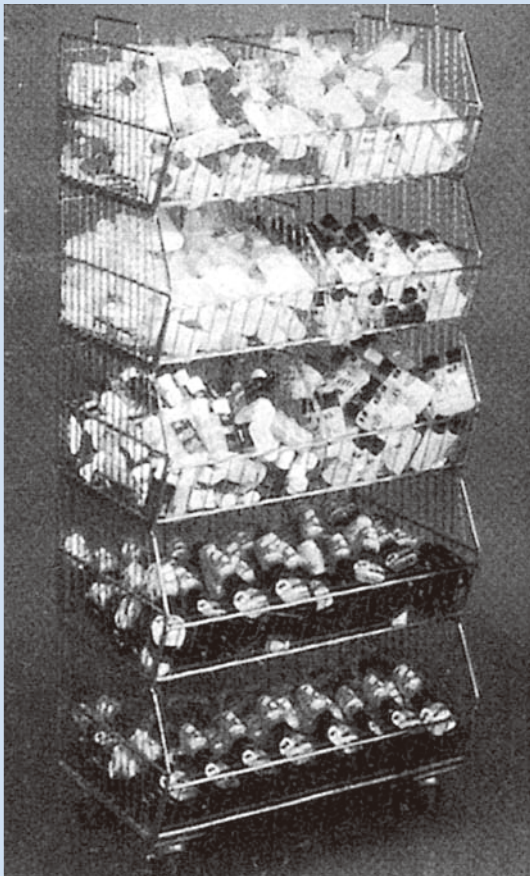

HIGH CAPACITY STACKING BASKETS

Comes complete with 3" heavy duty casters allowing ease of movement to any location in store.

Casters are welded to bottom basket. Each basket is 24"W. Sides are 10"H and front lip is 4½"H.

Choice of 14" or 20" deep. Overall height of unit is 54". Chrome finish

Item	Size
# SB2414	24"W × 14"D × 54"H
# SB2420	24"W × 20"D × 54"H



WIRE DUMP BIN

Size: 18" × 18" × 37"H
Shelf adjusts to a max. depth of 26"
with signholder, Zinc plated.

W18

WIRE DUMP BIN

Size: 24" × 24" × 37"H
Shelf adjusts to a max. depth of 26"
with signholder, Zinc plated.

W24

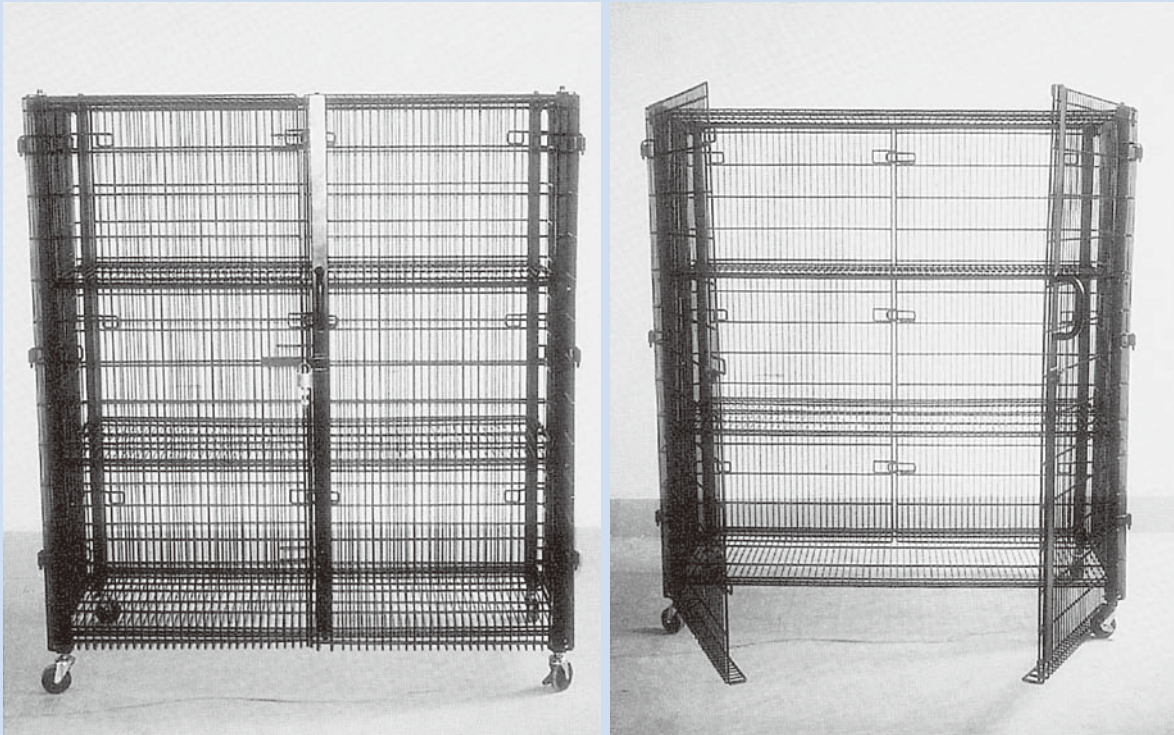

SECURITY CART

with 4 pcs. of 3" Locking casters,
Including 1 pc. Lock & 2 pcs. Keys

Matte Black Finish

Size : 52" L × 24"W × 54"H

SC522454MB

I

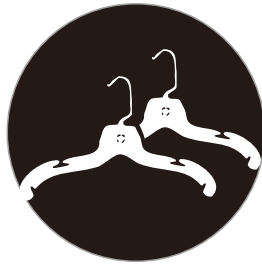

HANGERS

CHAPTER	DIVISION	CONTENTS
I	01	WOODEN HANGER
	02	STEEL HANGER
	03	PLASTIC HANGER
	04	BAMBOO HANGER
	05	OTHER HANGER & ACCESSORIES



17" SUIT HANGER

HW1-NA

In natural wood with wood dowel, chrome wire clamp & hook.

HW1-WA

In walnut finish with wood dowel, brass plated wire clamp & hook.

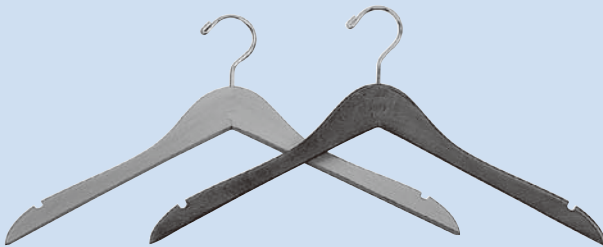

17" FLAT DRESS HANGER

With notches at the top

HW3-NA

In natural wood with chrome hook.

HW3-WA

In walnut finish with brass hook.

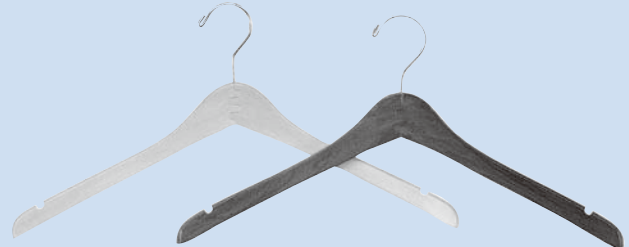

17" CONTOURED DRESS HANGER

With notches at the top

HW4-NA

In natural wood with chrome hook.

HW4-WA

In walnut finish with brass hook.

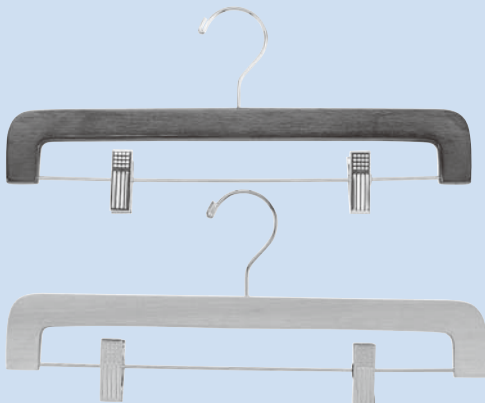

14" LADIES SKIRT HANGER

HW5-NA

In natural wood with chrome plated wire, clips & hook.

HW5-WA

In walnut finish with brass plated wire, clips & hook.



17" LADIES SUIT HANGER

With notches at the top

HW6-NA

In natural wood with chrome plated wire, clips & hook.

HW6-WA

In walnut finish with brass plated wire, clips & hook.



WOODEN HANGERS

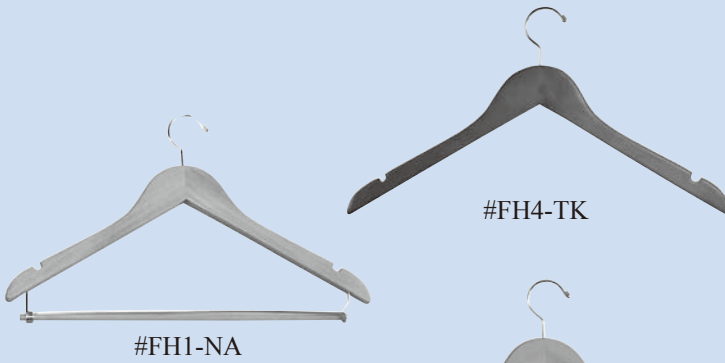

#FH1-NA

#FH4-TK

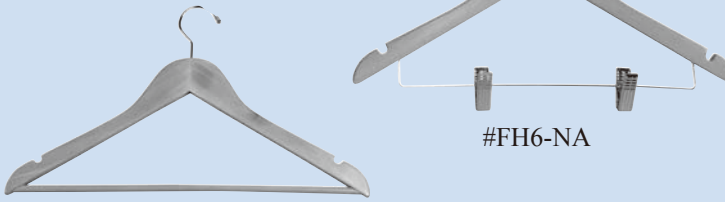

#FH2-NA

#FH6-NA

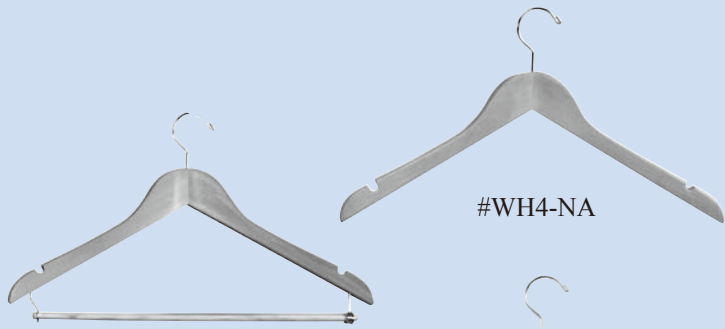

#WH1-NA

#WH4-NA

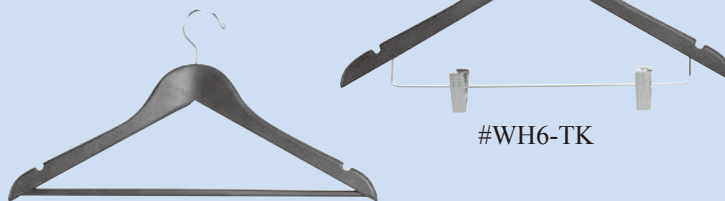

#WH2-TK

#WH6-TK

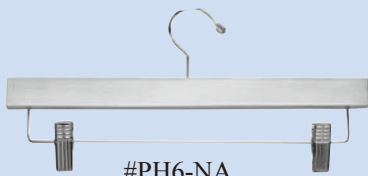

#PH6-NA



#PH6-TK

17" FLAT HANGERS

FH1-NA

With chrome hook, clamp & wooden bar on spring, natural color.

FH2-NA

With chrome hook & wooden bar, natural color.

FH4-NA

With chrome hook, natural color.

FH6-NA

With chrome hook & metal wire bar w/clips, natural color.

FH4-TK

With satin chrome hook, teak color.

FH4-TK-BR

-ditto- but with brass hook.

17" WISHBONE HANGERS

WH1-NA

With chrome hook, clamp & wooden bar on spring, natural color.

WH4-NA

With chrome hook, natural color

WH6-NA

With chrome hook & metal wire bar w/clips, natural color.

WH1-TK

With satin chrome hook, clamp & wooden bar on spring, teak color.

WH1-TK-BR

-ditto- but with brass hook & clamp.

WH2-TK

With satin chrome hook & wooden bar, teak color.

WH2-TK-BR

-ditto- but with brass hook.

WH4-TK

With satin chrome hook, teak color.

WH4-TK-BR

-ditto- but with brass hook.

WH6-TK

With satin chrome hook, & metal wire bar with clips, teak color.

WH6-TK-BR

-ditto- but with brass hook & metal wire bar with clips.

14" PANT/SKIRT HANGERS

PH6-NA

With chrome hook, metal wire bar with clips, natural color.

PH6-TK

With satin chrome hook & metal wire bar with clips, teak color.

PH6-TK-BR

-ditto- but with brass hook & metal wire bar with clips.



DH2-NA

17" Deluxe Natural Wooden Coat Hanger
with chrome hook

Any Color Finished may be available in quantities



CHROME PLATED



BLOUSE AND DRESS HANGER

Clamp Joint

With Loop Hook

- # BDH-12-LH 12"
- # BDH-14-LH 14"
- # BDH-16-LH 16"
- # BDH-18-LH 18"
- # BDH-19-LH 19"

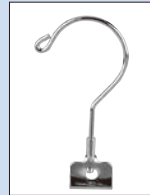

With Regular Hook

- # BDH-12
- # BDH-14
- # BDH-16
- # BDH-18
- # BDH-19

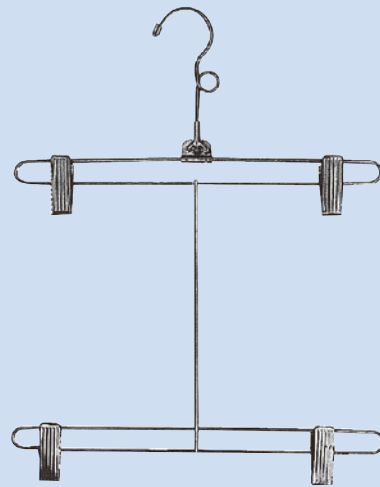

BIKINI BATHING SUIT HANGER

Clamp Joint

With Loop Hook

- # BBSH-12-LH 12"



With Regular Hook

- # BBSH-12

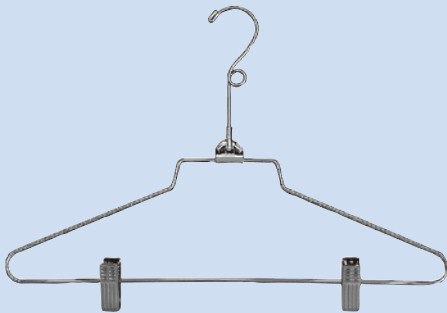

COMBINATION HANGER

Clamp Joint

With Loop Hook

- # CH-12-LH 12"
- # CH-14-LH 14"
- # CH-16-LH 16"

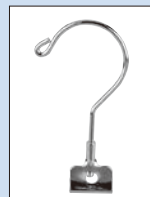

With Regular Hook

- # CH-12
- # CH-14
- # CH-16

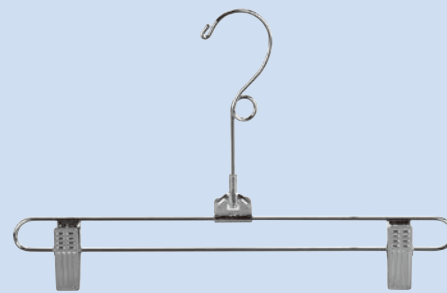

SKIRT HANGER

Clamp Joint

With Loop Hook

- # SH-12-LH 12"



With Regular Hook

- # SH-12

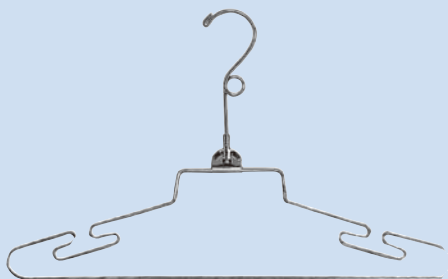

LINGERIE HANGER

Clamp Joint

With Loop Hook

- # LING-16-LH 16"



With Regular Hook

- # LING-16

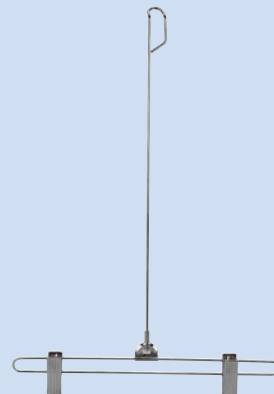

DROP ATTACHMENT HANGER

Clamp Joint

With Loop Hook

- # DA-9 9" drop
- # DA-16 16" drop



STEEL HANGERS

CHROME PLATED

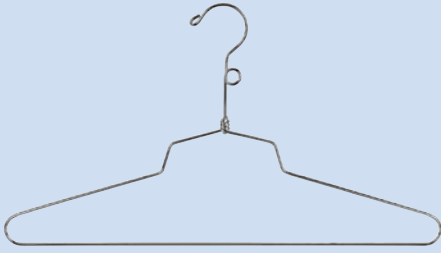

BLOUSE AND DRESS HANGER

Twist Joint

With Loop Hook

- # BDH-12-LH-T 12"
- # BDH-14-LH-T 14"
- # BDH-16-LH-T 16"
- # BDH-18-LH-T 18"
- # BDH-19-LH-T 19"



With Regular Hook

- # BDH-12-T
- # BDH-14-T
- # BDH-16-T
- # BDH-18-T
- # BDH-19-T

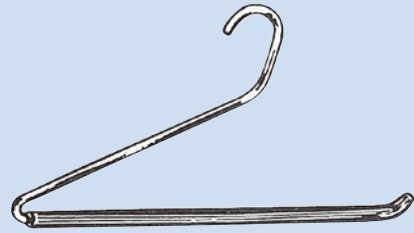

SLACK HANGER

Drape style with white plastic ribbed cover for sure-grip.

14" Wide

400

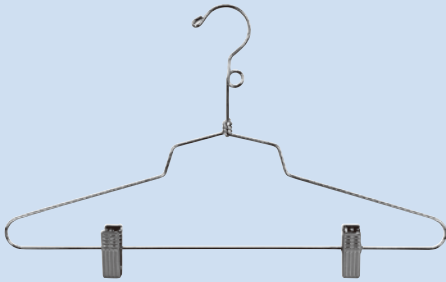

COMBINATION HANGER

Twist Joint

With Loop Hook

- # CH-12-LH-T 12"
- # CH-14-LH-T 14"
- # CH-16-LH-T 16"



With Regular Hook

- # CH-12-T
- # CH-14-T
- # CH-16-T

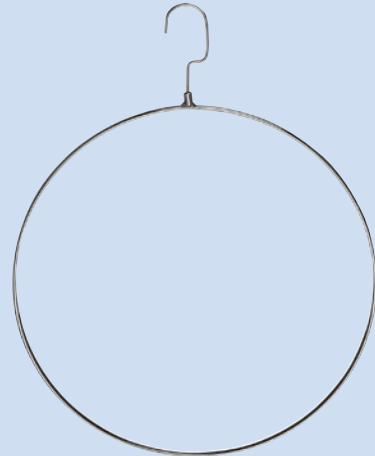

BIKINI / PANTY HANGER

15' Dia. Ring

PR-15

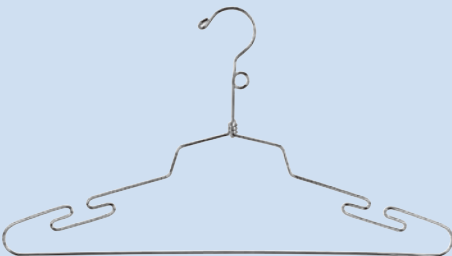

LINGERIE HANGER

Twist Joint

With Loop Hook

- # LING-16-LH-T 16"



With Regular Hook

- # LING-16-T



DIAPER PIN ROD

To hold loop hook hangers together.

14" Length

DPR-14

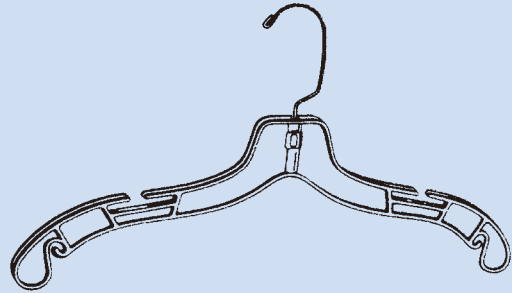
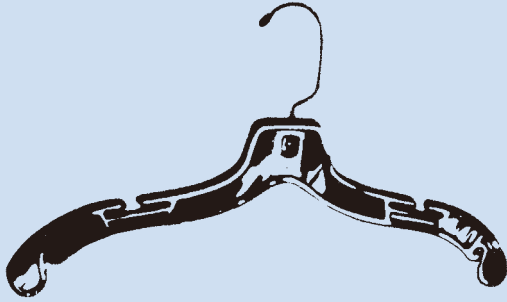

17" LADIES DRESS HANGER

With swivel hook

Heavy Weight

- # D60B Black with black hook
- # D60C Clear with zinc hook
- # D60W White with zinc hook

Super Heavy Weight

- # D70B Black with black hook
- # D70C Clear with zinc hook
- # D70W White with zinc hook

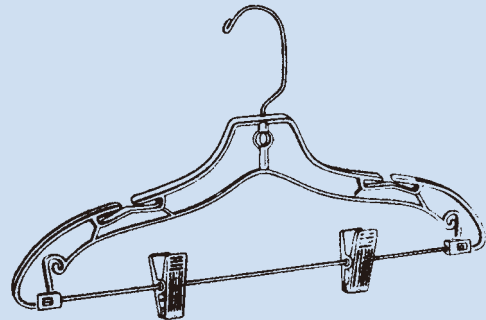
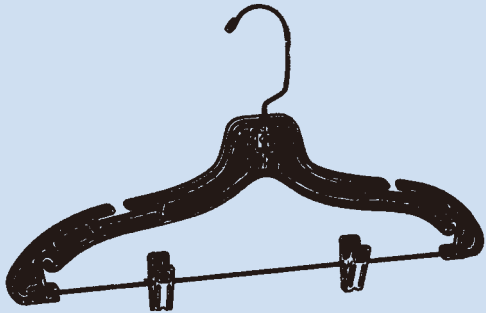

17" LADIES SUIT HANGER

With swivel hook & clips

Super Heavy Weight

- # D70B-PC Black with plastic clips & black hook
- # D70C-MC Clear with metal clips & zinc hook
- # D70W-MC White with metal clips & zinc hook

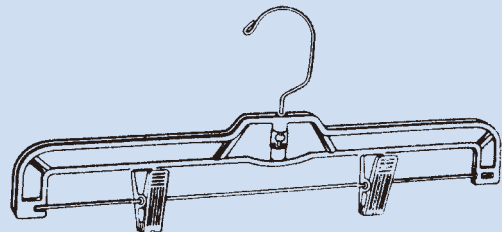
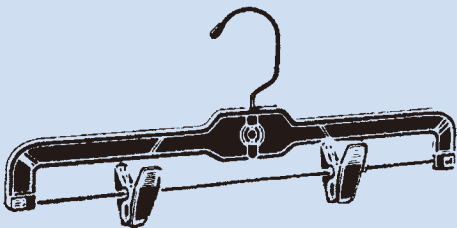

14" LADIES SKIRT HANGER

With swivel hook & clips

Heavy Weight

- # S80B-PC Black with plastic clips & black hook
- # S80C-MC Clear with metal clips & zinc hook
- # S80W-MC White with metal clips & zinc hook



PLASTIC HANGERS

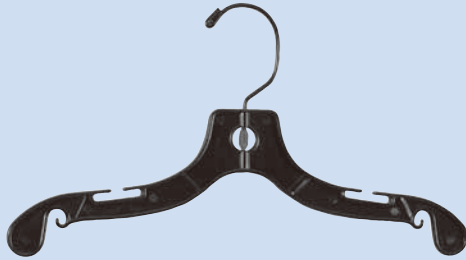

CHILD DRESS HANGER

With swivel hook

10"	12"	14"	
# D10B	# D12B	# D14B	Black with black hook
# D10C	# D12C	# D14C	Clear with zinc hook
# D10W	# D12W	# D14W	White with zinc hook

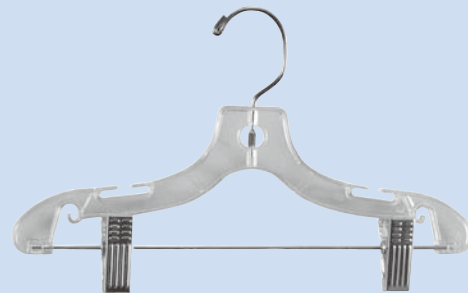

CHILD SUIT HANGER

With swivel hook & clips

12"	14"	
# D12B-PC	# D14B-PC	Black with plastic clips & black hook
# D12C-MC	# D14C-MC	Clear with metal clips & zinc hook
# D12W-MC	# D14W-MC	White with metal clips & zinc hook

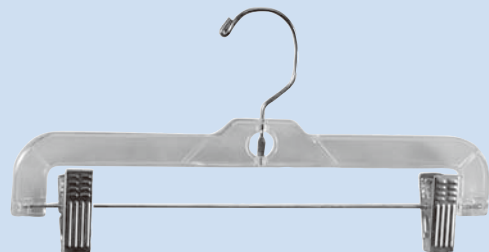
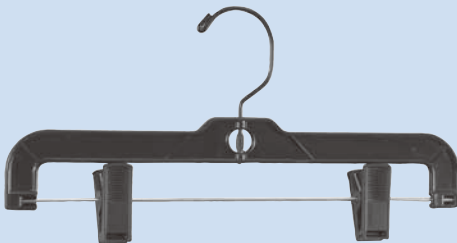

12" CHILD SKIRT HANGER

With swivel hook & clips

# S75B-PC	Black with plastic clips & black hook
# S75C-MC	Clear with metal clips & zinc hook
# S75W-MC	White with metal clips & zinc hook

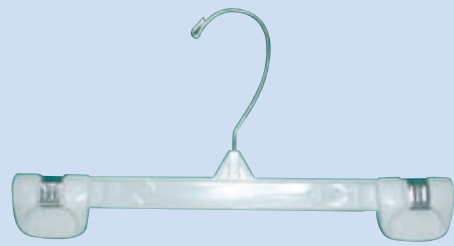

SNAP HANGER

With Zinc hook

10"	12"	
# I3-1-10B	# I3-1-12B	Black
# I3-1-10C	# I3-1-12C	Clear
# I3-1-10W	# I3-1-12W	White



SNAP HANGER

With Plastic hook

10"	12"	
# I3-2-10B	# I3-2-12B	Black
# I3-2-10C	# I3-2-12C	Clear
# I3-2-10W	# I3-2-12W	White



The Bamboo is growing by the hour
and cause less damage to our planet



FBH4

17" Flat Natural Bamboo Top Hanger
with chrome hook

WBH4

17" Wishbone Natural Bamboo Top Hanger
with chrome hook



FBH2

17" Flat Natural Bamboo Top Hanger
with Bar & chrome hook

WBH2

17" Wishbone Natural Bamboo Top Hanger
with Bar & chrome hook



FBH6

17" Flat Natural Bamboo Top Hanger
with Chrome hook, bar & clips

WBH6

17" Wishbone Natural Bamboo Top Hanger
with Chrome hook, bar & clips



BPH6

14" Natural Bamboo Pants Hanger
with chrome Regular Clips

Other Style of bamboo hanger may be available in quantities

OTHER HANGERS & ACCESSORIES

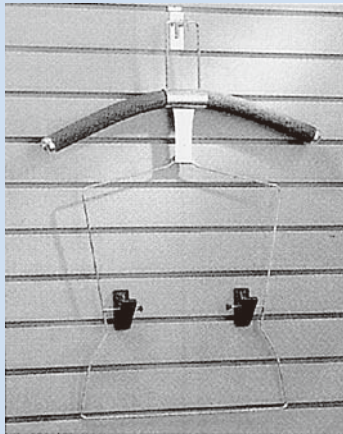

FLEXIBLE COORDINATE HANGER

Flexible ribbed foam shoulder and shaped chrome wire hanger gives life to your merchandise! Detachable drop has pant/skirt clips. Loop at top fits hooks and faceout arms. Bends to fit any size.

FRHWD

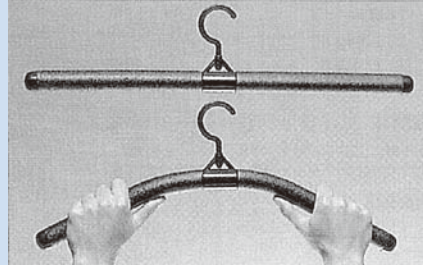

BENDABLE FOAM PE HANGER

Easily shaped to enhance any garment. All black with swivel hook. 21" long.

BFH



SATIN COVERED HANGER

Truly luxurious, satin padded hanger 1 3/8" thick x 15 1/4" long with matching bow. Hook is covered with vinyl tube in matching color.

- #SPH30 Beige
- #SPH31 Pink
- #SPH32 Light blue
- #SPH33 White
- #SPH34 Yellow
- #SPH35 Purple
- #SPH36 Orange
- #SPH37 Black



PLASTIC "PIGGYBACK" CONNECTOR

Join two or more hangers together for a coordinate display or as a space saver!

PBC

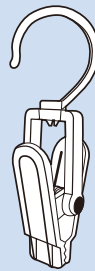

SUPER MIGHTY CLIP

4" overall length with 1/4" dia. rotating ring. Spring clip holds items tight.

- # SMC Clear
- # SMC-B Black
- # SMC-W White

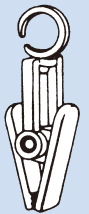
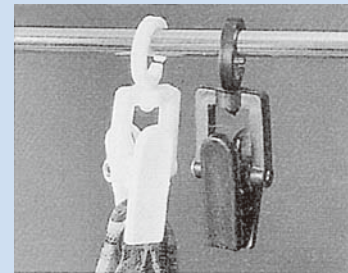

MIGHTY CLIP

2" overall length with 3/8" dia. rotating ring. Spring clip holds items tight.

- # MC Clear
- # MC-B Black
- # MC-W White

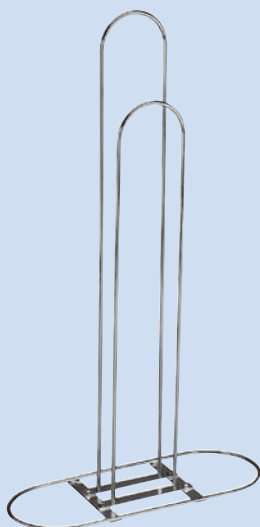

OVAL BASED HANGER STACKER

Keep hangers neat and untangled. Heavy chrome plated steel wire. Holds up to 100 hangers.

Item	Pack/per carton
# CS19-10	10 pcs
# CS19-3	3 pcs
# CS19-1	1 pcs

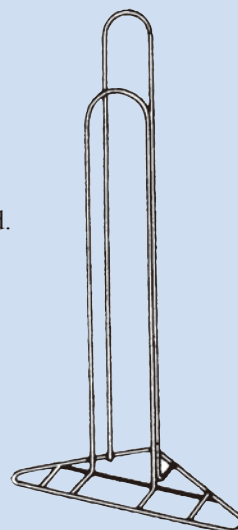

TRIANGLE BASED HANGER STACKER

Keep hangers neat and untangled. Heavy chrome plated steel wire. Holds up to 100 hangers.

Item	Pack/per carton
# CS19-T-10	10 pcs
# CS19-T-3	3 pcs
# CS19-T-1	1 pcs

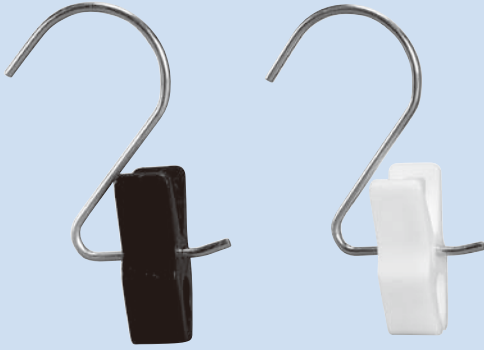

ALL PURPOSE HANGER CLIP

- # **WHC-B** Wire hook w/black clip
- # **WHC-W** Wire hook w/white clip



HANGING "S" HOOK

- 4.0mm dia.wire
- Zinc Plated
- # **SH-2** 2"L
- # **SH-3** 3"L
- # **SH-4** 4"L



ROUND SIZE DIVIDERS

- Fits round & square tubes
- Dia. 3-1/2"

CD-W (Alphabets or numbers) -- White with Black prints/ 100 per box
 # **CD-W** Blank White / 100 per box
 # **CD-B** (Alphabets or numbers) -- Black with Gold prints / 100 per box



RECTANGULAR DIVIDERS

- Fits Round, square and rectangular tubes
- 2"W x 5"H

RD-W (Alphabets or numbers) -- White with Black prints/ 100 per box
 # **RD-W** Blank White/ 100 per box

SIZE CHART

1	2	3	3X	4	5	6	6-1/2	6X	7	8	8-1/2	9	10	10-1/2
11	12	12-1/2	13	14	14-1/2	15	16	17	18	18-1/2	19	20	20-1/2	21
22	22-1/2	23	24	24-1/2	25	26	26-1/2	27	28	28-1/2	29	30	30-1/2	31
32	32-1/2	33	34	35	36	37	38	39	40	41	42	43	44	45
46	47	48	49	50	51	52	53	54	55	56	57	58	60	3Mo
6Mo	9Mo	12Mo	18Mo	24Mo	30Mo	36Mo	2T	3T	4T	3P	4P	5P	6P	7P
8P	9P	10P	11P	12P	13P	14P	15P	16P	17P	18P	20P	Petite	3/4	5/6
7/8	9/10	11/12	13/14	15/16	S	M	L	XS	XL	XXL	XXXL	Set	A-Z	Blank

We might need to charge you the mold fee if we don't have your printing icon.
 Please contact us for submitting more information.



MINI ROUND SIZE DIVIDERS

- Fits wire hook of hanger
- Dia. 3/4"

#MCD-W (Alphabets or numbers) -- White with Black prints/ 10,000 per box



SIZE CHART

1	2	3	3x	4	5	6	6-1/2	6x	7	8	8-1/2	9	10	10-1/2
11	12	12-1/2	13	14	14-1/2	15	16	17	18	18-1/2	19	20	20-1/2	21
22	22-1/2	23	24	24-1/2	25	26	26-1/2	27	28	28-1/2	29	30	30-1/2	31
32	32-1/2	33	34	35	36	37	38	39	40	41	42	43	44	45
46	47	48	49	50	51	52	53	54	55	56	57	58	60	3Mo
6Mo	9Mo	12Mo	18Mo	24Mo	30Mo	36Mo	2T	3T	4T	3P	4P	5P	6P	7P
8P	9P	10P	11P	12P	13P	14P	15P	16P	17P	18P	20P	Petite	3/4	5/6
7/8	9/10	11/12	13/14	15/16	S	M	L	XS	XL	XXL	XXXL	Set	A-Z	Blank

We might need to charge you the mold fee if we don't have your printing icon.
Please contact us for submitting more information.



HANGING WIRE CLIP STRIP

- Curved top hangs on shelving, pipes & cabinets
- Zinc plated

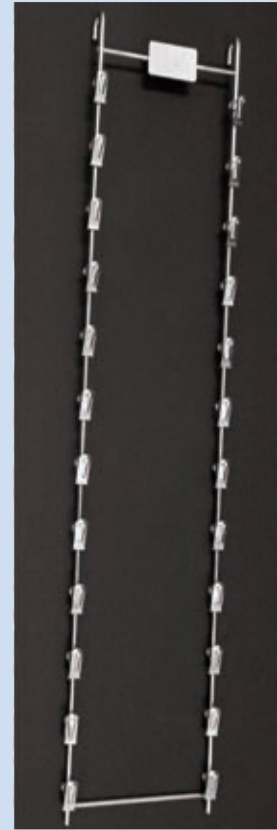

Single Strand

Double Strand

CLIP STRIP	Without Metal Tab	With Metal Tab
SINGLE STRAND 12-Clip, 32" Long.	#WCS-12	#WCS-12T
SINGLE STRAND 18-Clip, 47" Long.	#WCS-18	#WCS-18T
DOUBLE STRAND 24-Clip, 32" Long.	#WCS-24	#WCS-24T



COUNTER TOP - WIRE CLIP STRIP

Zinc plated



Double Strand

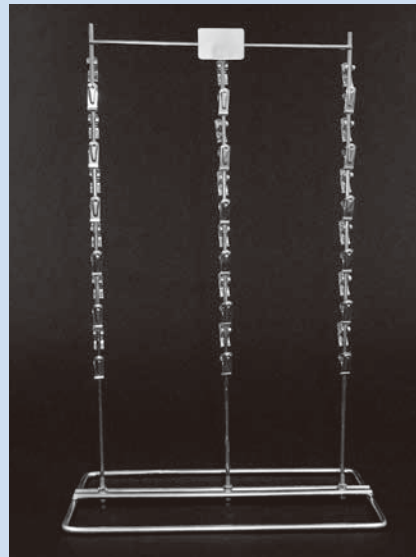
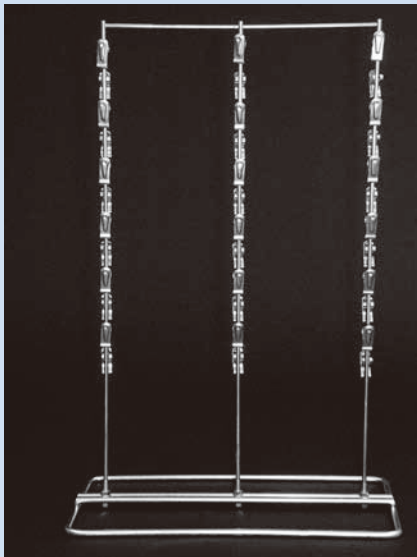

Triple Strand

CLIP STRIP	Without Metal Tab	With Metal Tab
DOUBLE STRAND 24-Clip, 23" Tall.	#WCS-24-CT	#WCS-24T-CT
TRIPLE STRAND 36-Clip, 23" Tall.	#WCS-36-CT	#WCS-36T-CT

J

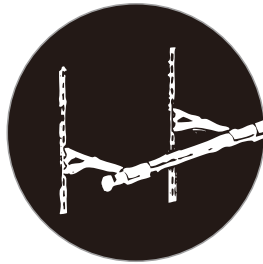

HANGRAILS, BRACKETS, SHELVING, STANDARDS & ETC.

CHAPTER	DIVISION	CONTENTS
J	01	HANGRAILS
	02	HANGRAIL ACCESSORIES
	03	HANGRAIL BRACKETS
	04	SHELVING
	05	SHELF BRACKETS
	06	STANDARDS
	07	SATIN FINISH



1" Round Tubing
(17 Gauge) - Chrome Plated

	Length
# CT1-4	4'
# CT1-5	5'
# CT1-6	6'
# CT1-8	8'
# CT1-10	10'
# CT1-12	12'

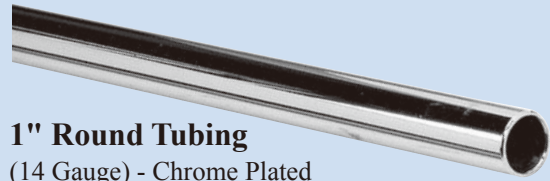

1" Round Tubing
(14 Gauge) - Chrome Plated

	Length
# HT1-4	4'
# HT1-5	5'
# HT1-6	6'
# HT1-8	8'
# HT1-10	10'
# HT1-12	12'

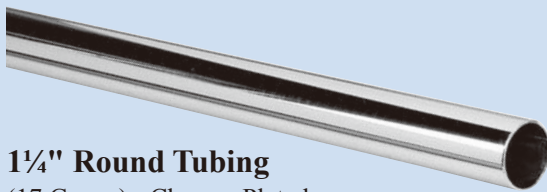

1/4" Round Tubing
(17 Gauge) - Chrome Plated

	Length
# CT5-4	4'
# CT5-5	5'
# CT5-6	6'
# CT5-8	8'
# CT5-10	10'
# CT5-12	12'



1-1/16" Round Tubing
(14 Gauge) - Chrome Plated

	Length
# HT3-4	4'
# HT3-5	5'
# HT3-6	6'
# HT3-8	8'
# HT3-10	10'
# HT3-12	12'



1" Square Tubing
(17 Gauge) - Chrome Plated

	Length
# ST4	4'
# ST5	5'
# ST6	6'
# ST8	8'
# ST10	10'
# ST12	12'

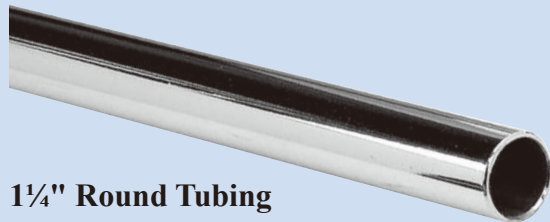

1/4" Round Tubing
(14 Gauge) - Chrome Plated

	Length
# HT5-4	4'
# HT5-5	5'
# HT5-6	6'
# HT5-8	8'
# HT5-10	10'
# HT5-12	12'



1/2x1/2" Rectangular Tubing
(17 Gauge) - Chrome Plated

	Length
# RT4	4'
# RT5	5'
# RT6	6'
# RT8	8'
# RT10	10'
# RT12	12'



CHROME PLATED END CAPS



EK1
For 1" and 1-1/16" tubing

EK5
For 1-1/4" and 1-5/16" tubing

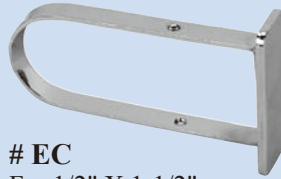

EC
For 1/2" X 1-1/2"
rectangular tubing

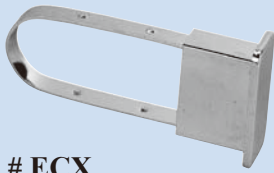

ECX
For 1/2" X 1-1/2"
rectangular tubing with 1"
extension

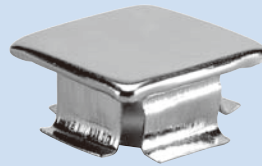

EC7
For 1" square tubing

"O" and "U" FLANGES POLISHED CHROME

"O" FLANGE

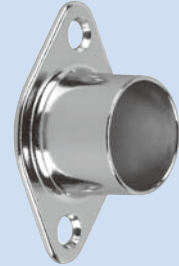

FO1
for 1" round tubing

SPLICERS

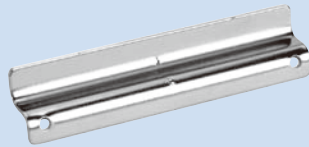

RT-SP
For rectangular tubing,
nickel plated

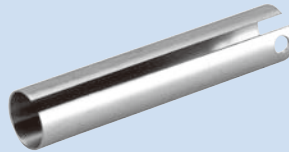

HT1-SP
For 1" round tubing, zinc plated

HT3-SP
For 1-1/16" round tubing, zinc plated

HT5-SP
For 1-1/4" round tubing, zinc plated



FO5
for 1-1/4" round tubing

LEVELER

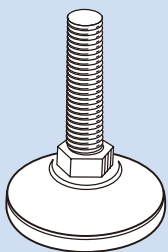

LVL38
3/8" thread

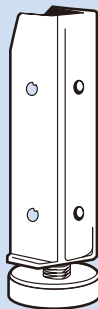

HEAVY DUTY INSERT # SQ/NT

To fit into 1" square tubing.
3/8" thread. includes leveler.
For use with casters.

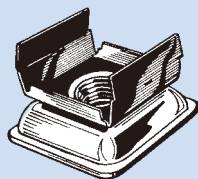

GRATER CLIP # SQ/GC

For 1" square tubing
3/8" thread

"U" FLANGE



FU1
for 1 round tubing



FU5
for 1-1/4" round tubing



HANGRAIL ACCESSORIES

FOR 1/2" x 1-1/2" RECT. TUBING

Chrome Plated



STRAIGHT FACEOUT

Item	Size
# RH3S	3"L
# RH6S	6"L
# RH12S	12"L

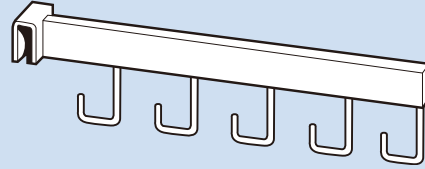

STRAIGHT FACEOUT W/5 HOOKS

15"L
SH5H



HOOKS, W/30° UPTURN

Item	Size
# RH1H	1"L
# RH4H	4"L
# RH6H	6"L
# RH8H	8"L
# RH9H	9"L
# RH10H	10"L
# RH12H	12"L

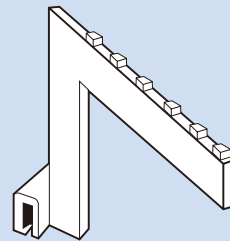

WATERFALL RISER

8" Vertical Riser
12"L Slant Arm
with 6 cubes
RH6C-VR

FOR WALL MOUNTING

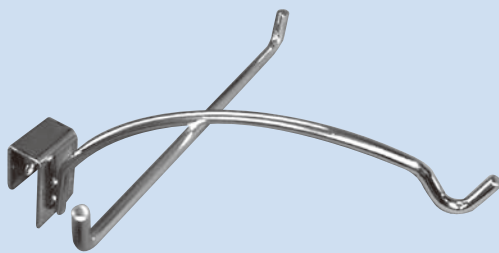

EYEGASSES DISPLAY

5-1/2"D x 5-1/2"W

# RHEG	Chrome
# RHEG-Z	Zinc
# RHEG-B	Black
# RHEG-W	White

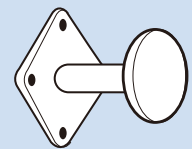
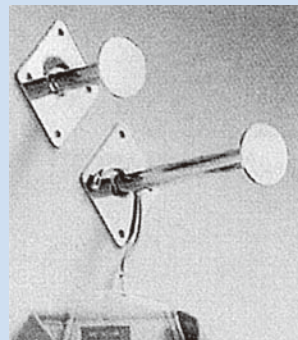

FITTING ROOM WALL HOOKS

With disk end

Item	Size
# WH3	3"L
# WH6	6"L

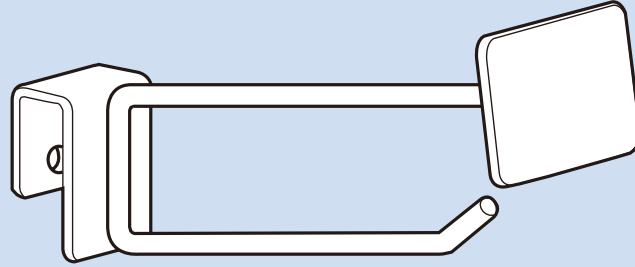

HANGRAIL SCANNER HOOK ZINC

Length	Metal Plate: 1-3/8"×3"×1.5mm Wire Dia. 0.187"	Metal Plate: 1-3/8"×3"×1.5mm Wire Dia. 0.225"	Metal Plate: 1-3/8"×2-1/8"×1.5mm Wire Dia. 0.187"	Metal Plate: 1-3/8"×2-1/8"×1.5mm Wire Dia. 0.225"
4"	M13H4-ME	M13H4-HD	M12H4-ME	M12H4-HD
6"	M13H6-ME	M13H6-HD	M12H6-ME	M12H6-HD
8"	M13H8-ME	M13H8-HD	M12H8-ME	M12H8-HD
10"	M13H10-ME	M13H10-HD	M12H10-ME	M12H10-HD
12"	M13H12-ME	M13H12-HD	M12H12-ME	M12H12-HD

HANGRAIL SCANNER HOOK CHROME

Length	Metal Plate: 1-3/8"×3"×1.5mm Wire Dia. 0.187"	Metal Plate: 1-3/8"×3"×1.5mm Wire Dia. 0.225"	Metal Plate: 1-3/8"×2-1/8"×1.5mm Wire Dia. 0.187"	Metal Plate: 1-3/8"×2-1/8"×1.5mm Wire Dia. 0.225"
4"	M13H4-ME-C	M13H4-HD-C	M12H4-ME-C	M12H4-HD-C
6"	M13H6-ME-C	M13H6-HD-C	M12H6-ME-C	M12H6-HD-C
8"	M13H8-ME-C	M13H8-HD-C	M12H8-ME-C	M12H8-HD-C
10"	M13H10-ME-C	M13H10-HD-C	M12H10-ME-C	M12H10-HD-C
12"	M13H12-ME-C	M13H12-HD-C	M12H12-ME-C	M12H12-HD-C



POLISHED CHROME

**SINGLE BRACKET WITH TUBE ATTACHED**

To fit universal 1/2" slots on 1" centers -
With nylon stabilizer

- # S112 - 12" for 1" & 1-1/16" hangrail
- # S114 - 14" for 1" & 1-1/16" hangrail
- # S512 - 12" for 1-1/4" hangrail
- # S514 - 14" for 1-1/4" hangrail

**DOUBLE BRACKET WITH TUBE ATTACHED**

To fit universal 1/2" slots on 1" centers -
With nylon stabilizer

- # D112 - 12" for 1" & 1-1/16" hangrail
- # D114 - 14" for 1" & 1-1/16" hangrail
- # D512 - 12" for 1-1/4" hangrail
- # D514 - 14" for 1-1/4" hangrail

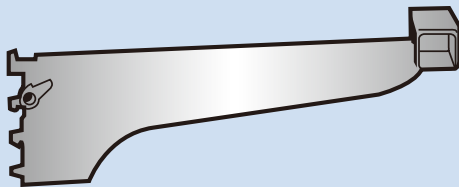
**BRACKET WITH SQUARE TUBE ATTACHED**

To fit universal 1/2" slots on 1" centers -
With nylon stabilizer

- # F112 - For holding 1" square tubing
12" long

**FLAT BRACKET WITH TUBE ATTACHED**

To fit universal 1/2" slots on 1" centers -
With locking screw

- # ALS112 - 12" for 1" & 1-1/16" hangrail
- # ALS114 - 14" for 1" & 1-1/16" hangrail
- # ALS212 - 12" for 1-1/4" hangrail
- # ALS214 - 14" for 1-1/4" hangrail

**PULL-OUT ROD**

- # PO17 - For single bracket
- # PO18 - For double bracket

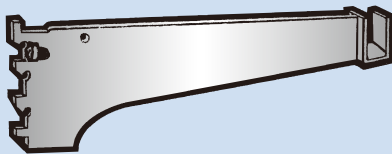
**BRACKET FOR HOLDING RECTANGULAR TUBING**

To fit universal 1/2" slots on 1" centers -
With tightening screw

- # CR12 - For holding 1/2" x 1-1/2"
rectangular tubing - 12" long
- # CR14 - 14" long

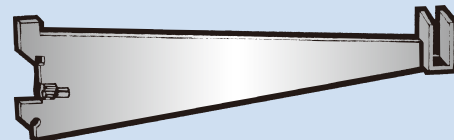
**HEAVY DUTY BRACKET FOR HOLDING RECTANGULAR TUBING**

To fit heavy duty 1" slots on 2" centers -
With tightening screw

- # GR12 - For holding 1/2" x 1-1/2"
rectangular tubing - 12" long

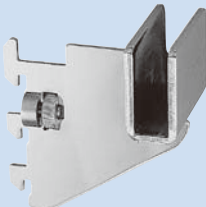
**BLADE BRACKET FOR HOLDING RECTANGULAR TUBING**

To fit universal 1/2" slots on 1" centers -
With tightening screw

- # BS3 - For holding 1/2" x 1-1/2"
rectangular tubing - 3" long

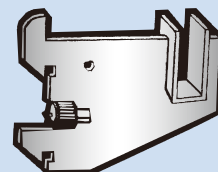
**HEAVY DUTY BLADE BRACKET FOR HOLDING RECTANGULAR TUBING**

To fit heavy duty 1" slots on 2" centers -
With tightening screw

- # BR3 - For holding 1/2" x 1-1/2"
rectangular tubing - 3" long



HANGRAIL BRACKETS

BRACKET ATTACHMENT

FOR UNIVERSAL SLOTTED STANDARDS
(1/2" SLOTS ON 1" CENTERS)
POLISHED CHROME FINISH

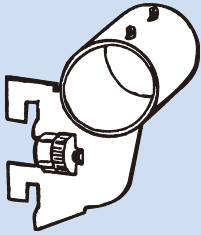

STUBBY BRACKET

- # **STB1** - for 1" & 1-1/16"
round tubing - rear mounted
- # **STB5** - for 1-1/4"
round tubing - rear mounted

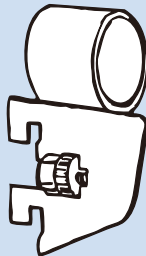

STUBBY BRACKET

- # **BS-15** - for 1" & 1-1/16"
round tubing - side mounted
- # **BS-25** - for 1-1/4"
round tubing - side mounted

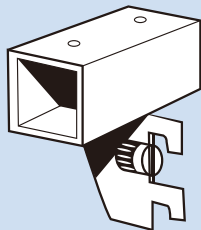

STUBBY BRACKET

- # **BS-ST** - for 1" square tubing
- rear mounted

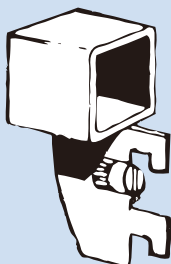

STUBBY BRACKET

- # **BS-SM** - for 1" square tubing
- side mounted

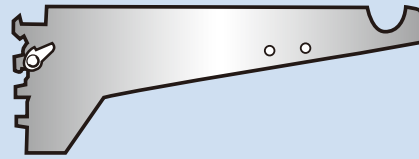

SINGLE BRACKET W/O "U" CUP

- # **5630-1-12** - 12" for 1" & 1-1/16" hangrail
- # **5630-1-14** - 14" for 1" & 1-1/16" hangrail
- # **5630-5-12** - 12" for 1-1/4" hangrail
- # **5630-5-14** - 14" for 1-1/4" hangrail

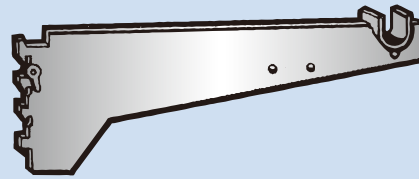

SINGLE BRACKET WITH "U" CUP

- # **5631-1-12** - 12" for 1" & 1-1/16" hangrail
- # **5631-1-14** - 14" for 1" & 1-1/16" hangrail
- # **5631-5-12** - 12" for 1-1/4" hangrail
- # **5631-5-14** - 14" for 1-1/4" hangrail

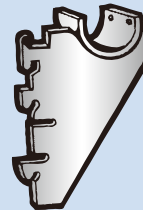

STUB BRACKET WITH "U" CUP

- # **5632-1** - for 1" & 1-1/16" hangrail
- # **5632-5** - for 1-1/4" hangrail

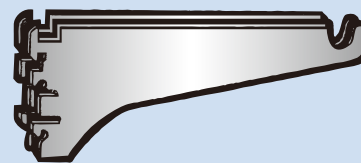

DOUBLE BRACKET W/O "U" CUP

- # **5633-1-12** - 12" for 1" & 1-1/16" hangrail
- # **5633-1-14** - 14" for 1" & 1-1/16" hangrail
- # **5633-5-12** - 12" for 1-1/4" hangrail
- # **5633-5-14** - 14" for 1-1/4" hangrail

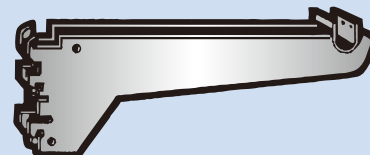

DOUBLE BRACKET WITH "U" CUP

- # **5634-1-12** - 12" for 1" & 1-1/16" hangrail
- # **5634-1-14** - 14" for 1" & 1-1/16" hangrail
- # **5634-5-12** - 12" for 1-1/4" hangrail
- # **5634-5-14** - 14" for 1-1/4" hangrail



CHROME PLATED



ALL-PURPOSE BLADE BRACKET FOR SNAP-ON ATTACHMENT

For universal 1/2" slots on 1" centers -
With nylon stabilizer

HBS12 - 12" blade # HBS14 - 14" blade



HEAVY DUTY BLADE BRACKET FOR SNAP-ON ATTACHMENT

For 1" slots on 2" centers -
With tightening screw

HBR10 - 10" blade # HBR14 - 14" blade
HBR12 - 12" blade # HBR16 - 16" blade



ONE TOOTH HEAVY DUTY BRACKET

For 1" slots on 2" center

4141-10 10" L # 4141-14 14" L
4141-12 12" L # 4141-16 16" L

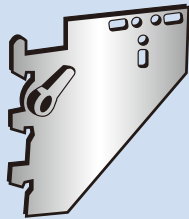

STUBBY BRACKET FOR SNAP-ON ATTACHMENT

For 1/2" slots on 1" center
H1 - stubby bracket

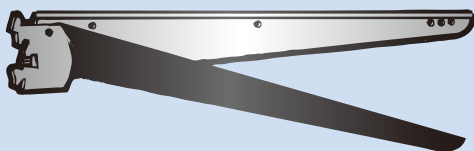

HEAVY DUTY ADJUSTABLE BRACKETS

For 1" slots on 2" center, Adjusts to 5
positions: 15° upslant, horizontal, 15°, 30°
& 45° downslant, with stabilizer screw.

4215-12 12" L # 4215-14 14" L

SNAP-ON SPRING CLAMP SOCKET

CLC1 - center for 1" & 1-1/16" hangrail
CLC5 - center for 1-1/4" & 1-5/16" hangrail
CLL1 - left end for 1" & 1-1/16" hangrail
CLL5 - left end for 1-1/4" & 1-5/16" hangrail
CLR1 - right end for 1" & 1-1/16" hangrail
CLR5 - right end for 1-1/4" & 1-5/16" hangrail



SNAP-ON SOCKET WITH TUBE ATTACHED

RDC1 - center for 1" & 1-1/16" hangrail
RDC5 - center for 1-1/4" hangrail
RDL1 - left end for 1" & 1-1/16" hangrail
RDL5 - left end for 1-1/4" hangrail
RDR1 - right end for 1" & 1-1/16" hangrail
RDR5 - right end for 1-1/4" hangrail



"U" CUP

UC1 - center for 1" & 1-1/16" hangrail
UC2 - center for 1-1/4" hangrail
UE1 - end for 1" & 1-1/16" hangrail
UE2 - end for 1-1/4" hangrail

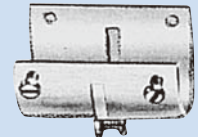

SNAP-ON SOCKET

For 1/2" x 1-1/2" Rectangular Tubing

RTC - center
RTL - left
RTR - right

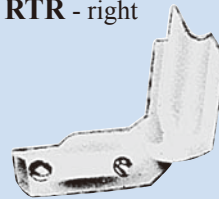
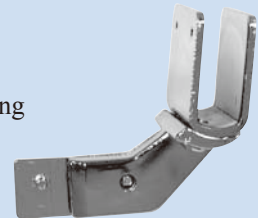

SNAP-ON SOCKET FOR "J" RAIL

JC7 - center
JL7 - left
JR7 - right



HOLD DOWN CLAMP

HDC - for double bracket
1" & 1-1/16" tubing
HDC2 - for double bracket
1-1/4" tubing



HEAVY CORNICE BRACKET

For 1" slots on 2" center

CH5145-24 Adj. 24"-30"
CH5145-30 Adj. 30"-36"



BRACKET FOR HOLDING RECTANGULAR TUBING

To fit universal 1/2" slots on 1" centers,
With tightening screw

Made of 1/2"×1-1/2" rectangular tubing chrome

Item	Size
# CR6R	6" L
# CR9R	9" L
# CR12R	12" L
# CR14R	14" L

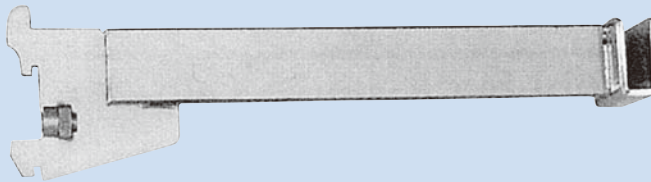

HEAVY DUTY BRACKET FOR HOLDING RECTANGULAR TUBING

To fit heavy duty 1" slots on 2" centers,
With tightening screw

Made of 1/2"×1-1/2" rectangular tubing chrome

Item	Size
# GR6R	6" L
# GR9R	9" L
# GR12R	12" L
# GR14R	14" L



BULLNOSE INJECTION MOLDED SHELVES WITH OPEN BOTTOM

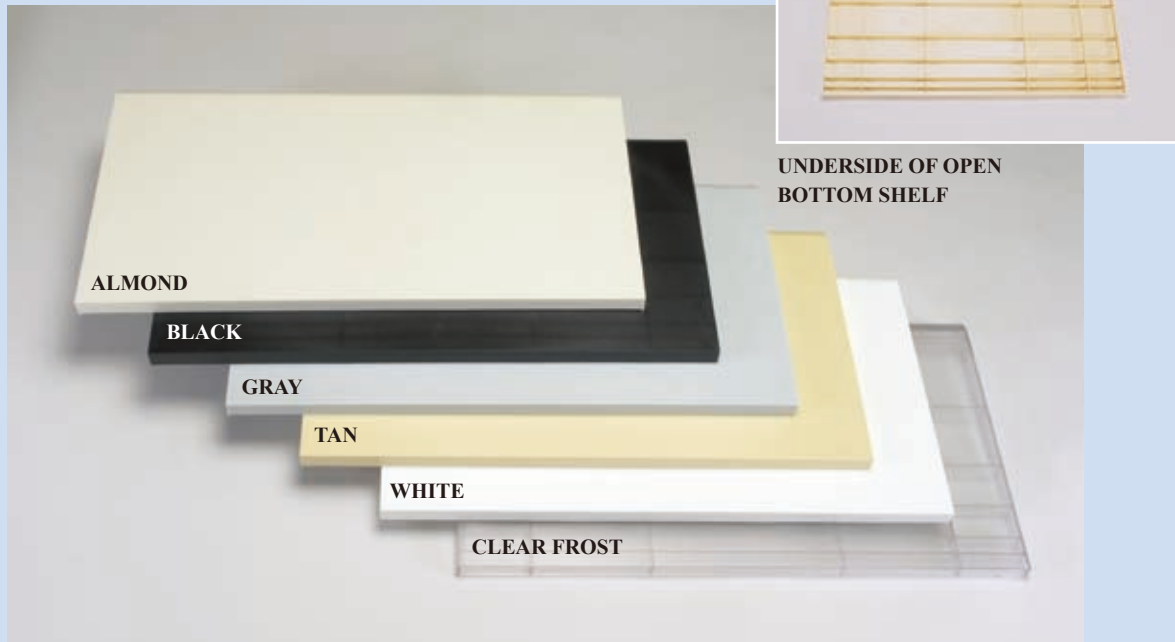

Item	Size	Color
# PS1324A	13" × 24"	Almond
# PS1324B	13" × 24"	Black
# PS1324G	13" × 24"	Gray
# PS1324T	13" × 24"	Tan
# PS1324W	13" × 24"	White
# PS1324CF	13" × 24"	Clear Frost
# PS1348A	13" × 48"	Almond
# PS1348B	13" × 48"	Black
# PS1348G	13" × 48"	Gray
# PS1348T	13" × 48"	Tan
# PS1348W	13" × 48"	White
# PS1348CF	13" × 48"	Clear Frost
# PS1548A	15" × 48"	Almond
# PS1548B	15" × 48"	Black
# PS1548G	15" × 48"	Gray
# PS1548T	15" × 48"	Tan
# PS1548W	15" × 48"	White
# PS1548CF	15" × 48"	Clear Frost



**WOOD GRAIN
BULLNOSE INJECTION MOLDED SHELVES
WITH OPEN BOTTOM**



Item	Size	Color
# PS1324C	13" × 24"	Cherry
# PS1324M	13" × 24"	Maple
# PS1324O	13" × 24"	Oak
# PS1348C	13" × 48"	Cherry
# PS1348M	13" × 48"	Maple
# PS1348O	13" × 48"	Oak



MELAMINE WOOD SHELVING

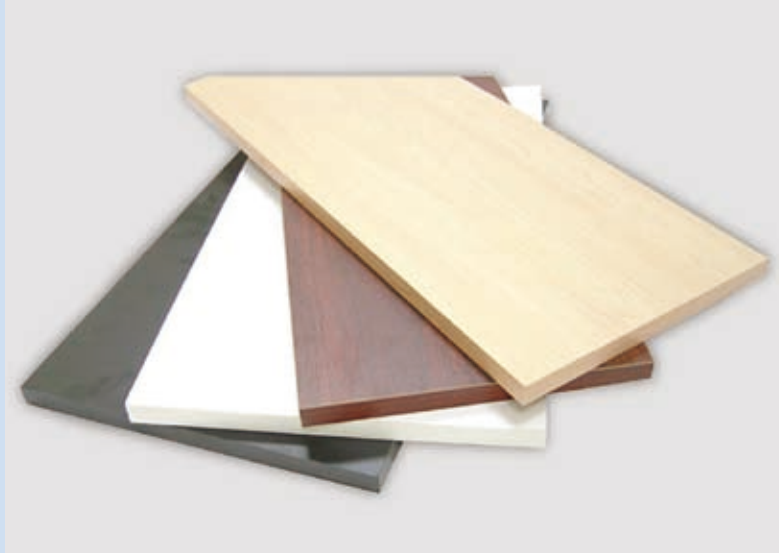

Item	Size	Color
# WS1024B	10" × 24"	Black
# WS1024CH	10" × 24"	Cherry
# WS1024MP	10" × 24"	Maple
# WS1024W	10" × 24"	White
# WS1024WA	10" × 24"	Walnut
# WS1048B	10" × 48"	Black
# WS1048CH	10" × 48"	Cherry
# WS1048MP	10" × 48"	Maple
# WS1048W	10" × 48"	White
# WS1048WA	10" × 48"	Walnut
# WS1224B	12" × 24"	Black
# WS1224CH	12" × 24"	Cherry
# WS1224MP	12" × 24"	Maple
# WS1224W	12" × 24"	White
# WS1224WA	12" × 24"	Walnut
# WS1248B	12" × 48"	Black
# WS1248CH	12" × 48"	Cherry
# WS1248MP	12" × 48"	Maple
# WS1248W	12" × 48"	White
# WS1248WA	12" × 48"	Walnut

- 3/4" Thickness melamine laminated
- Bracket sold separately



FOR UNIVERSAL SLOTTED STANDARDS (1/2" SLOTS ON 1" CENTERS)



WEDGE TYPE SHELF BRACKET CHROME

Item	Length
# 4010-6	6"
# 4010-8	8"
# 4010-10	10"
# 4010-12	12"
# 4010-14	14"
# 4010-16	16"

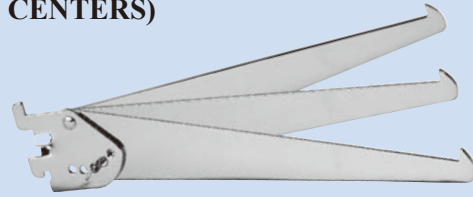

WEDGE TYPE ADJUSTABLE SHELF BRACKETS CHROME

Six position - straight, 15°, 30°, 45°, 60°
downslant, 15° upslant

Item	Length
# BWE10	10"
# BWE12	12"
# BWE14	14"



SHELF BRACKET SCREW TIGHTENING, CHROME

Item	Length
# 120-10	10"
# 120-12	12"
# 120-14	14"
# 120-16	16"



BRACKETS FOR WOOD SHELVES CHROME

# BWSC12	# BWSC14	# BWSC16
Center - 12"	Center - 14"	Center - 16"
# BWSL12	# BWSL14	# BWSL16
Left - 12"	Left - 14"	Left - 16"
# BWSR12	# BWSR14	# BWSR16
Right - 12"	Right - 14"	Right - 16"

SHELF RESTS FOR MEDIUM DUTY BRACKETS ZINC PLATED



220C
Center Clip

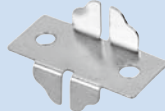

220F
Front Clip



220E
End Clip



223
Rubber Bumper
Grey color



GLASS SHELF SUPPORT ALUMINUM

Item	Length
# 6266-24-AL	24"
# 6266-30-AL	30"
# 6266-36-AL	36"
# 6266-48-AL	48"
# 6266-60-AL	60"

METAL

# 6266-48-ME	48"
--------------	-----

ZINC PLATED

SNAP-IN SHELF RESTS FOR HEAVY DUTY BRACKETS ZINC PLATED

"Snap-In" Feature Secures Rests To Shelf Bracket.



M1173
CENTER



F1173
FRONT

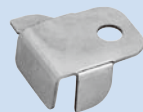

L1173
LEFT END

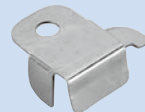

R1173
RIGHT END

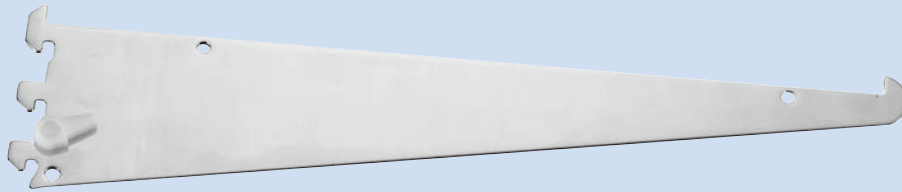

SHELF BRACKETS WITH NYLON STABILIZER

To fit universal 1/2" slots on 1" centers
chrome

Item	Sizes
# BNY12	12" L
# BNY14	14" L



SHELF BRACKETS WITH NYLON STABILIZER

To fit universal 1/2" slots on 1" centers
chrome

Item	Sizes
# B120-10	10" L
# B120-12	12" L
# B120-14	14" L

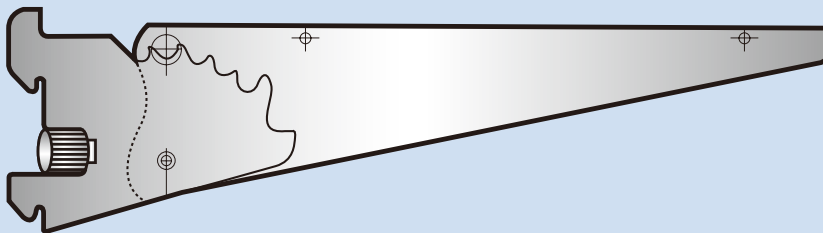

HEAVY DUTY ADJUSTABLE BRACKET

To fit heavy duty 1" slots on 2" centers
with tightening screw, w/o front lip.
chrome, 12" Long

1284-12 ADJ



125

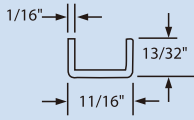
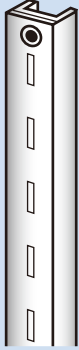

124

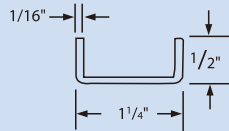
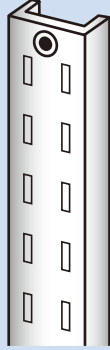

131

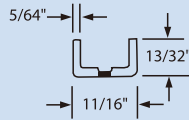

134

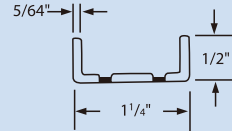
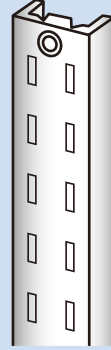

1204

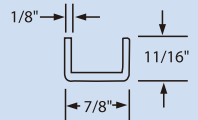
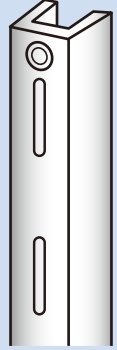

Medium Weight - Zinc Plated
Steel Thickness: 1/16" (.062")
Universal - 1/2" Slots on 1" Centers
Countersunk mounting screw
holes 12" apart

Heavy Weight - Zinc Plated
Steel Thickness: 5/64" (.078")
Universal - 1/2" Slots on 1" Centers
Countersunk mounting screw
holes 12" apart

Extra Heavy Duty - Zinc Plated
Steel Thickness: 1/8" (.125")
1" Slots on 2" Centers
Countersunk mounting screw
holes 12" apart

Style No.	Slot Type	Length	Style No.	Slot Type	Length	Style No.	Slot Type	Length
#125-3	Single	36"	#131-3	Single	36"	#1204-3	Single	36"
#125-4	Single	48"	#131-4	Single	48"	#1204-4	Single	48"
#125-5	Single	60"	#131-5	Single	60"	#1204-5	Single	60"
#125-6	Single	72"	#131-6	Single	72"	#1204-6	Single	72"
#125-7	Single	84"	#131-7	Single	84"	#1204-7	Single	84"
#125-8	Single	96"	#131-8	Single	96"	#1204-8	Single	96"
#124-3	Double	36"	#134-3	Double	36"			
#124-4	Double	48"	#134-4	Double	48"			
#124-5	Double	60"	#134-5	Double	60"			
#124-6	Double	72"	#134-6	Double	72"			
#124-7	Double	84"	#134-7	Double	84"			
#124-8	Double	96"	#134-8	Double	96"			



**CONCEALED WALL STEEL
T - STANDARDS
A-LINE**

Heavy Weight

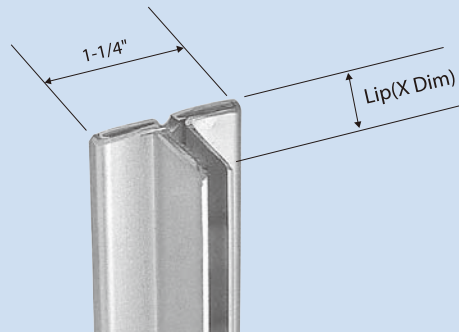

Backplate Thickness: 5/64"(0.078")
1/2" Slots on 1" Centers
Countersunk mounting screw holes 12" apart

ZINC PLATED			BLACK EPOXY		
Item #	Lip(X Dim)	Length	Item #	Lip(X Dim)	Length
A21S-6	7/16"	72"	A21S-6B	7/16"	72"
A21S-7	7/16"	84"	A21S-7B	7/16"	84"
A21S-8	7/16"	96"	A21S-8B	7/16"	96"
A21S-10	7/16"	120"	A21S-10B	7/16"	120"
A21S-12	7/16"	144"	A21S-12B	7/16"	144"
A21M-6	11/16"	72"	A21M-6B	11/16"	72"
A21M-7	11/16"	84"	A21M-7B	11/16"	84"
A21M-8	11/16"	96"	A21M-8B	11/16"	96"
A21M-10	11/16"	120"	A21M-10B	11/16"	120"
A21M-12	11/16"	144"	A21M-12B	11/16"	144"
A21L-6	13/16"	72"	A21L-6B	13/16"	72"
A21L-7	13/16"	84"	A21L-7B	13/16"	84"
A21L-8	13/16"	96"	A21L-8B	13/16"	96"
A21L-10	13/16"	120"	A21L-10B	13/16"	120"
A21L-12	13/16"	144"	A21L-12B	13/16"	144"



CONCEALED WALL STEEL T - STANDARDS B-LINE

Extra Heavy Duty

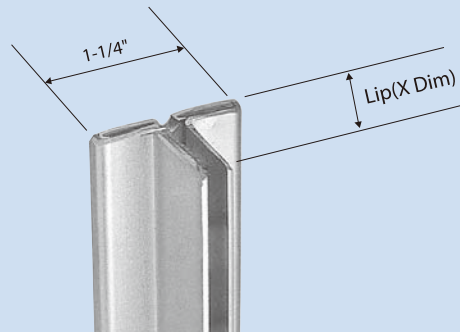

Backplate Thickness: 1/8"(0.125")
 1/2" Slots on 1" Centers
 Countersunk mounting screw holes 12" apart

ZINC PLATED			BLACK EPOXY		
Item #	Lip(X Dim)	Length	Item #	Lip(X Dim)	Length
B31S-6	7/16"	72"	B31S-6B	7/16"	72"
B31S-7	7/16"	84"	B31S-7B	7/16"	84"
B31S-8	7/16"	96"	B31S-8B	7/16"	96"
B31S-10	7/16"	120"	B31S-10B	7/16"	120"
B31S-12	7/16"	144"	B31S-12B	7/16"	144"
B31M-6	11/16"	72"	B31M-6B	11/16"	72"
B31M-7	11/16"	84"	B31M-7B	11/16"	84"
B31M-8	11/16"	96"	B31M-8B	11/16"	96"
B31M-10	11/16"	120"	B31M-10B	11/16"	120"
B31M-12	11/16"	144"	B31M-12B	11/16"	144"
B31L-6	13/16"	72"	B31L-6B	13/16"	72"
B31L-7	13/16"	84"	B31L-7B	13/16"	84"
B31L-8	13/16"	96"	B31L-8B	13/16"	96"
B31L-10	13/16"	120"	B31L-10B	13/16"	120"
B31L-12	13/16"	144"	B31L-12B	13/16"	144"



CHROMED ACCESSORIES FOR B-LINE T-STANDARDS



BLADE SHELF BRACKET

B12 - 12" Long



RECT TUBING FACEOUT

Made of 1/2" × 1-1/2" rect tubing

BRS12 - 12" Long

BRS14 - 14" Long

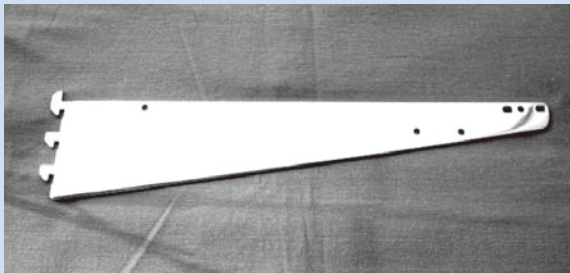

ALL-PURPOSE BLADE BRACKET

BHBS12 - 12" Long

BHBS14 - 14" Long

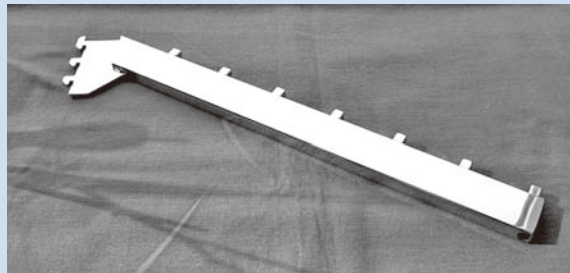

**7 CUBE RECT TUBING
WATERWALL**

Made of 1/2" × 1-1/2" rect tubing

BRS7C

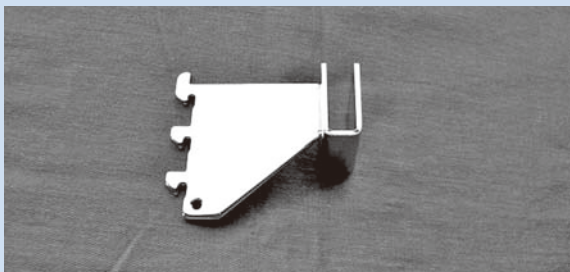

BLADE BRACKET

For holding 1/2" × 1-1/2" rect tubing

BBS3 - 3" Long

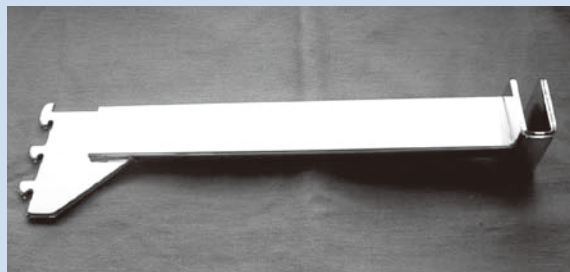

RECT TUBING BRACKET

For holding 1/2" × 1-1/2" rect tubing

Made of 1/2" × 1-1/2" rect tubing

BCR12R - 12" Long



CONCEALED WALL STEEL T - STANDARDS C-LINE

Extra Heavy Duty

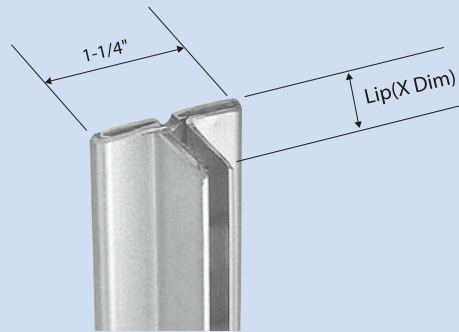

Backplate Thickness: 1/8"(0.125")
 1" Slots on 2" Centers
 Countersunk mounting screw holes 12" apart

ZINC PLATED			BLACK EPOXY		
Item #	Lip(X Dim)	Length	Item #	Lip(X Dim)	Length
C32S-6	7/16"	72"	C32S-6B	7/16"	72"
C32S-7	7/16"	84"	C32S-7B	7/16"	84"
C32S-8	7/16"	96"	C32S-8B	7/16"	96"
C32S-10	7/16"	120"	C32S-10B	7/16"	120"
C32S-12	7/16"	144"	C32S-12B	7/16"	144"
C32M-6	11/16"	72"	C32M-6B	11/16"	72"
C32M-7	11/16"	84"	C32M-7B	11/16"	84"
C32M-8	11/16"	96"	C32M-8B	11/16"	96"
C32M-10	11/16"	120"	C32M-10B	11/16"	120"
C32M-12	11/16"	144"	C32M-12B	11/16"	144"
C32L-6	13/16"	72"	C32L-6B	13/16"	72"
C32L-7	13/16"	84"	C32L-7B	13/16"	84"
C32L-8	13/16"	96"	C32L-8B	13/16"	96"
C32L-10	13/16"	120"	C32L-10B	13/16"	120"
C32L-12	13/16"	144"	C32L-12B	13/16"	144"

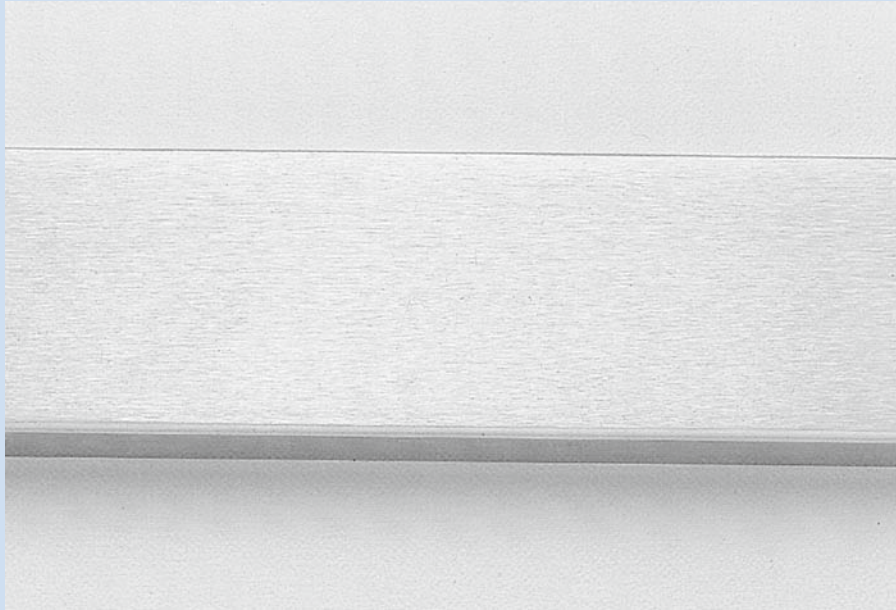

SATIN CHROME FINISH (GRIT #180)



1/2"×1-1/2" RECTANGULAR TUBING

17 Gauge, Satin Chrome

RT2-SC 2"L

RT4-SC 4"L

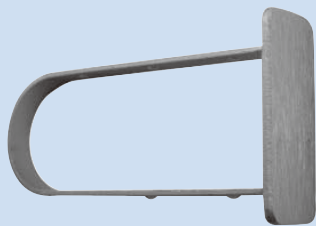

END CAP

For 1/2"× 1-1/2" rectangular tubing
Satin Chrome

EC-SC

ECX-SC (with 1" extension)

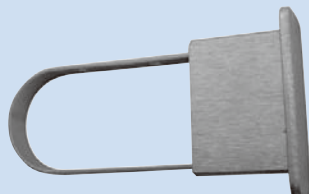



WEDGE TYPE SHELF BRACKET

To fit universal 1/2" slots on 1" centers
Satin Chrome

4010-12SC 12"L

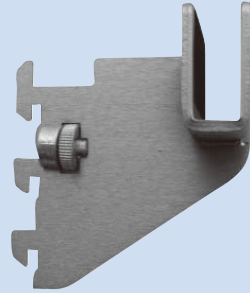

BLADE BRACKET FOR HOLDING RECTANGULAR TUBING

To fit universal 1/2" slots on 1" centers
With tightening screw
Satin Chrome

BS3-SC 3"L



ALL-PURPOSE BLADE BRACKET FOR SNAP-ON ATTACHMENT

To fit universal 1/2" slots on 1" centers
With nylon stabilizer
Satin Zinc

HBS12-SZ 12"L

HBS14-SZ 14"L



BRACKET FOR HOLDING RECTANGULAR TUBING

To fit universal 1/2" slots on 1" centers,
With tightening screws.
Made of 1/2" x 1-1/2" rectangular tubing
Satin Chrome

CR12R-SC 12"L



BRACKETS FOR WOOD SHELVES

To fit universal 1/2" slots on 1" centers
Satin Zinc

BWSC12-SZ # BWSL12-SZ # BWSR12-SZ
Center ~ 12" Left ~ 12" Right ~ 12"

BWSC14-SZ # BWSL14-SZ # BWSR14-SZ
Center ~ 14" Left ~ 14" Right ~ 14"



STRAIGHT FACEOUT

To fit universal 1/2" slots on 1" centers
Made of 1/2" x 1-1/2" rectangular tubing
Satin Chrome

RDW12-SC 12"L

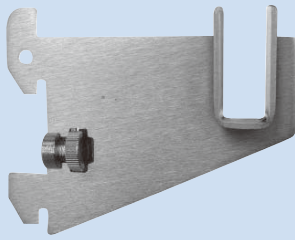

HEAVY DUTY BLADE BRACKET FOR HOLDING RECTANGULAR TUBING

To fit heavy duty 1" slots on 2" centers
With tightening screw, Satin Chrome

BR3-SC 3"L

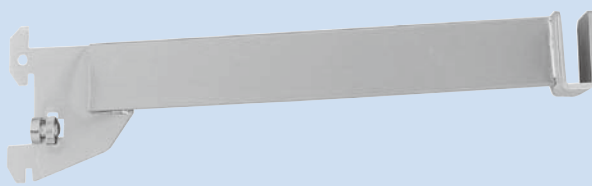

HEAVY DUTY BRACKET FOR HOLDING RECTANGULAR TUBING

To fit heavy duty 1" slots on 2" centers
With tightening screw
Made of 1/2" x 1-1/2" rectangular tubing
Satin Chrome

GR8R-SC 8"L
GR12R-SC 12"L



HEAVY DUTY BLADE BRACKET FOR SNAP-ON ATTACHMENT

To fit heavy duty 1" slots on 2" centers
With tightening screw
Satin Chrome

HBR12-SC 12"L



STRAIGHT FACEOUT

To fit heavy duty 1" slots on 2" centers
Made of 1/2" x 1-1/2" rectangular tubing
Satin Chrome

RR12-SC 12"L

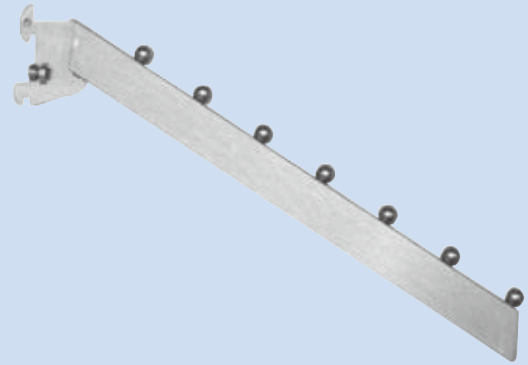

7 BALL WATERFALL

To fit heavy duty 1" slots on 2" centers
Made of 1/2" x 1-1/2" rectangular tubing
Satin Chrome

RR7B-SC 17"L



STRAIGHT FACEOUT

Horizontal mount on 1/2" x 1-1/2" rect. tubing
Made of 1/2" x 1-1/2" rectangular tubing
Satin Chrome

RH6S-SC 6"L
RH12S-SC 12"L

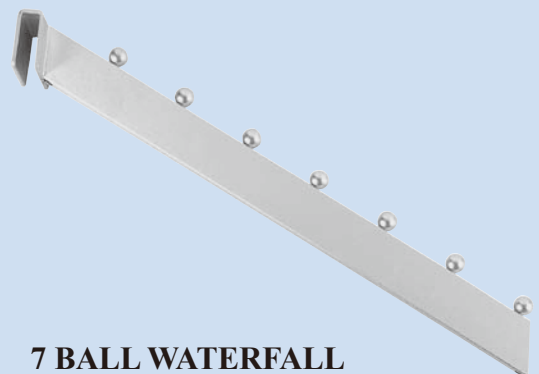

7 BALL WATERFALL

Horizontal mount on 1/2" x 1-1/2" rect. tubing
Made of 1/2" x 1-1/2" rectangular tubing
Satin Chrome

RH7B-SC 17"L

K



LIGHTING

CHAPTER	DIVISION	CONTENTS
K	01	TRACK LIGHTS & ACCESSORIES



STANDARD VOLTAGE FIXTURES

For halogen and incandescent lamps

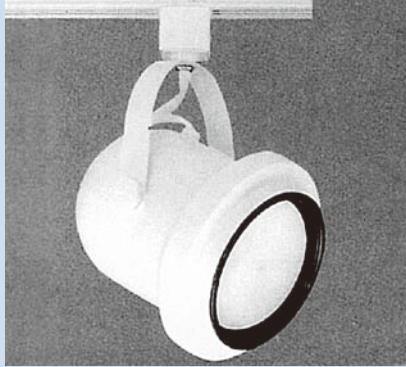

BELL CYLINDER STYLE

Style	Color	Diameter	Length
# ATH-395S	white/black	4-1/2"	5"
# ATH-395L	white/black	5-1/2"	6-1/4"
# ATH-395XL	white/black	7"	8-1/4"



FLAT BACK CYLINDERS

Style	Color	Diameter	Length
# ATH-313	white/black	3-1/2"	6"
# ATH-315	white/black	4-1/2"	7"



ROUND BACK CYLINDERS

Style	Color	Diameter	Length
# ATH-108S	white/black	3-1/2"	5-3/4"
# ATH-108M	white/black	4-1/2"	6-3/4"



STEP CYLINDERS

Style	Color	Diameter	Length
# ATH-104S	white/black	3-1/2"	4-1/4"
# ATH-104L	white/black	4-1/2"	6-1/4"



LOW VOLTAGE HALOGEN FIXTURES

Use with MR16 Lamps - 12 volt - 50 watt (Transformers included)

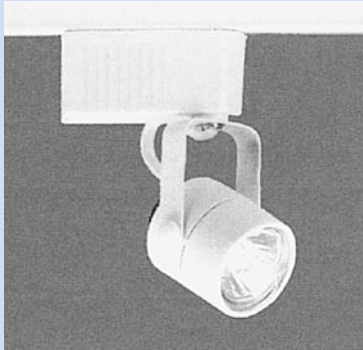

ALH-02
white/black
D: 2-1/4" L: 3"
Round cylinder (swivel)



ALH-07
white/black
D: 2-1/4" L: 3"
Square style (swivel)

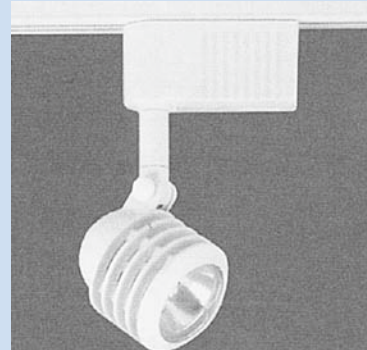

ALH-16B
white/black
D: 2-3/4" L: 3-1/8"
Beehive style on post (swivel)

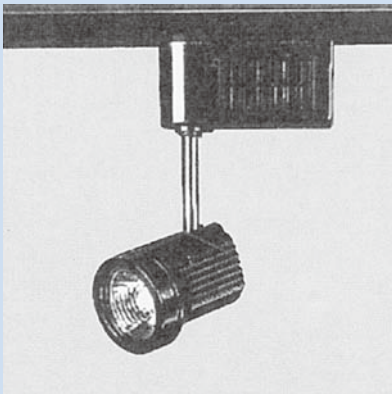

ALH-25
white/black
D: 2-1/4" L: 3"
Euro style on post (non- swivel)

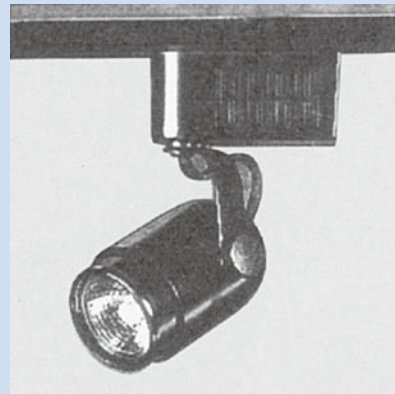

ALH-33
white/black
D: 2-3/4" L: 4-1/4"
Round back style (swivel)

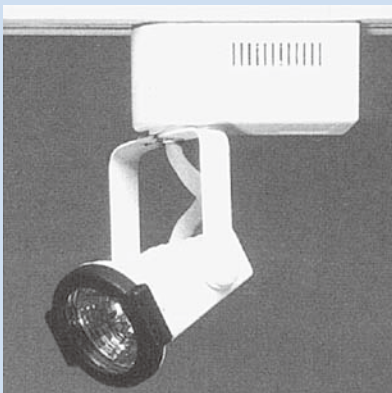

ALH-42U
white/black
D: 2-1/2" L: 3"
Mini spot (swivel)

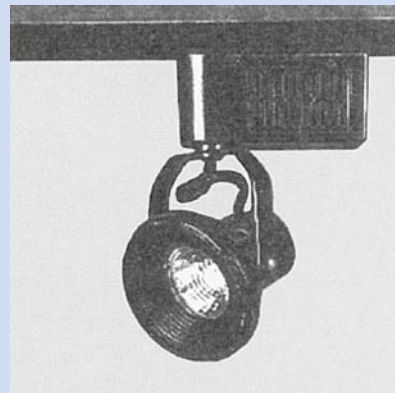

ALH-45
white/black
D: 3-1/4" L: 3"
Satellite style (swivel)



ACCESSORIES FOR TRACK LIGHTING

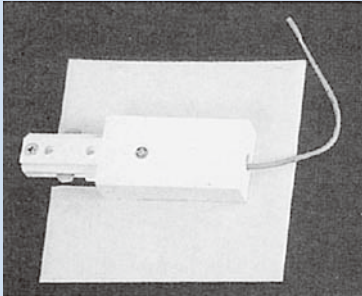

CE-3 white/black
Live End W/Canopy
 Live End Connector to start a run.

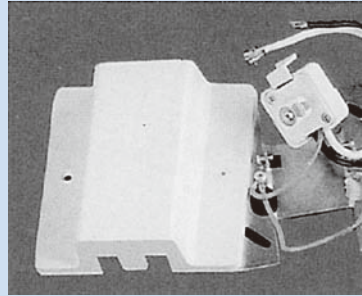

CF-3 white/black
Floating Canopy
 Track can be connected to existing outlet box located anywhere along the track. Comes with canopy cover, connector, end cap and mounting hardware.

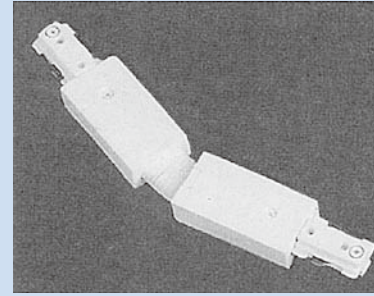

FX-3 white/black
Flexible Connector
 Connects two track sections at any angle up to 90°, or permits track to run from ceiling to wall, or in other configurations.

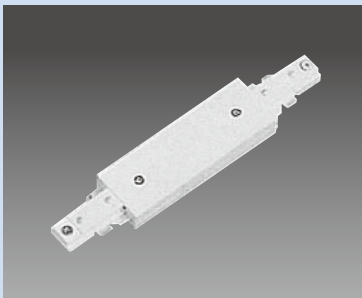

I-3 white/black
I-Feedable Connector
 Connects two track sections end-to-end.

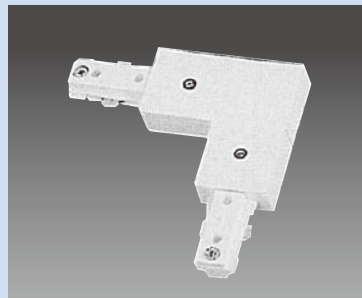

L-3 white/black
L-Feedable Connector
 Connects two track sections at a 90° angle.



SI-3 white/black
Mini Connector
 Connects two track sections end-to-end with minimum 1/8" space between track (No feed).

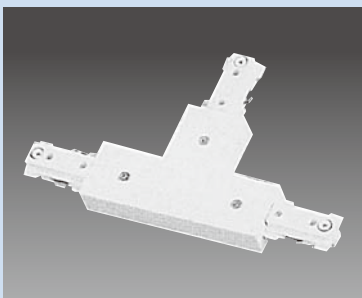

T-3 white/black
T-Feedable Connector
 Connects three track sections in 'T' configuration.

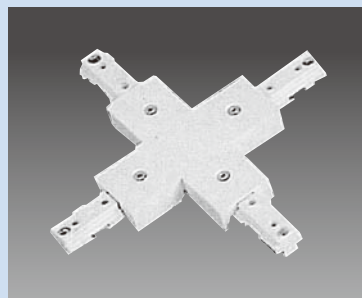

X-3 white/black
X-Feedable Connector
 Connects four track sections in cross configuration.

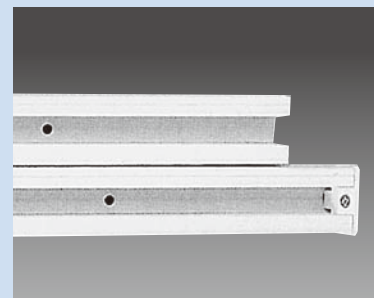

SURFACE TRACK		
Item	Color	Length
# ATH-24	white/black	2'
# ATH-48	white/black	4'
# ATH-96	white/black	8'

L



MANNEQUINS & FORMS

CHAPTER	DIVISION	CONTENTS
L	01	ABSTRACT
	02	FLAT
	03	FLEXIBLE
	04	RATTAN
	05	REALISTIC
	06	TUBULAR
	07	FORM
	08	MANNEQUINS SHOW I
	09	MANNEQUINS SHOW II
	10	SEXY
	11	ACCESSORIES
	12	PLASTIC MANNEQUINS
	13	ELITE SERIES

ABSTRACT FEMALE FULL FORM



- Made of textured fiberglass in black or white.
- Only two inches in depth. Overall height: 71"
- Stands on 15-1/2" round chrome base.
- Available in three poses

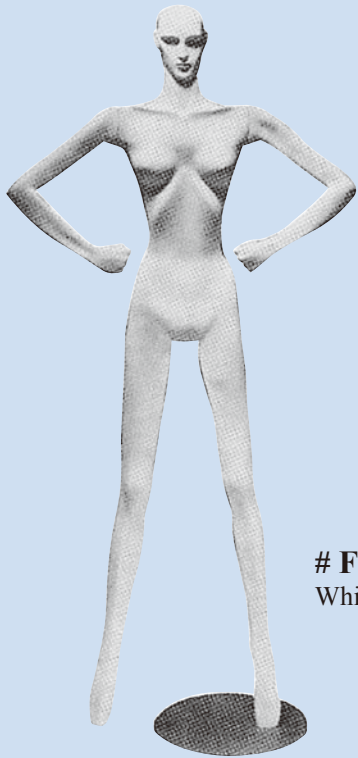

FF73-W
White



FF74-W
White

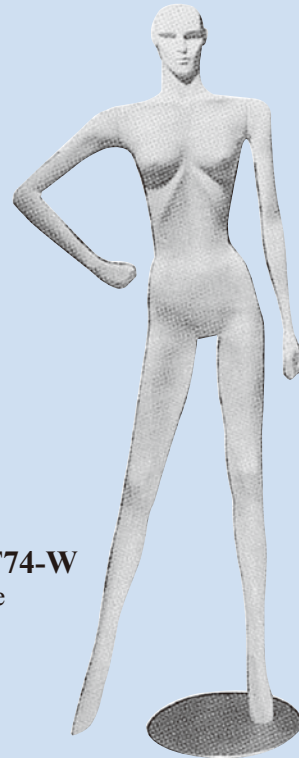

FF75-W
White

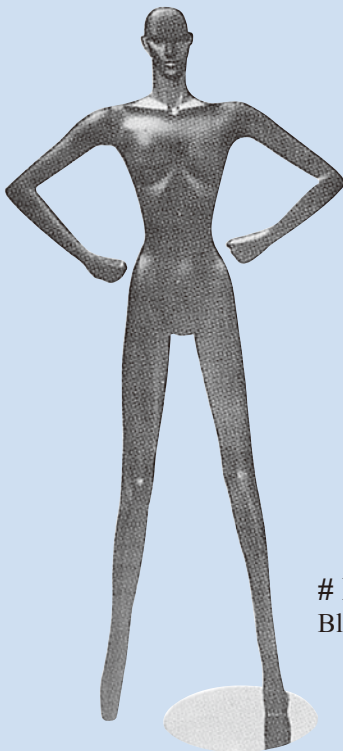

FF73-B
Black

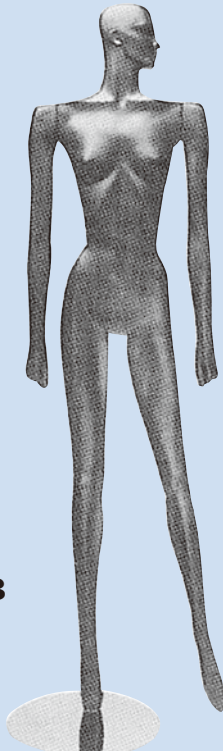

FF74-B
Black



FF75-B
Black



ABSTRACT

MALE FULL FORM

- Made of textured fiberglass in black or white.
- Only two inches in depth. Overall height: 71".
- Stands on 15-1/2" round chrome base.
- Available in three poses.

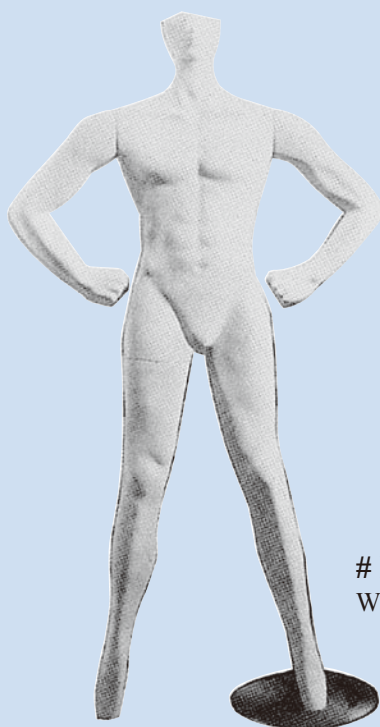

FF77-W
White

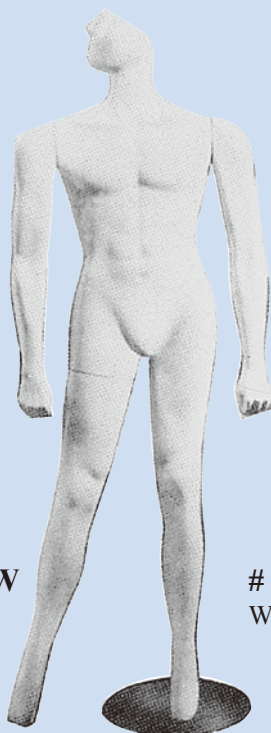

FF78-W
White



FF79-W
White

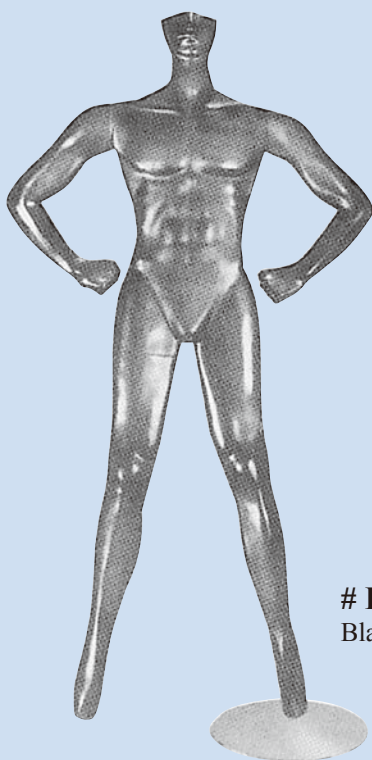

FF77-B
Black

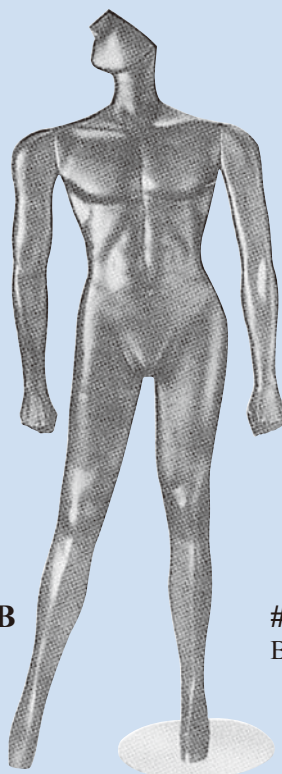

FF78-B
Black

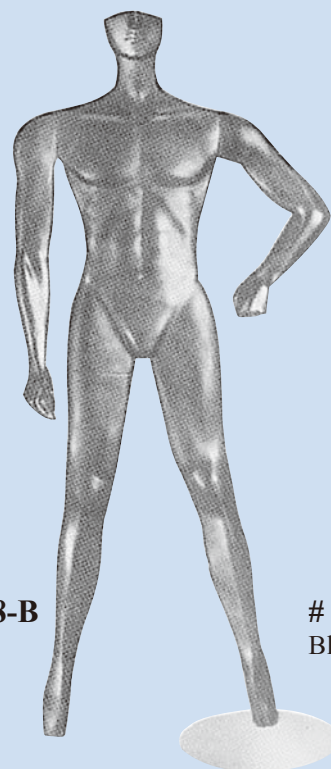

FF79-B
Black

ABSTRACT

FEMALE & MALE HALF FORM



- 12" Round chrome base included
- Made of textured fiberglass.
Only two inches in depth.

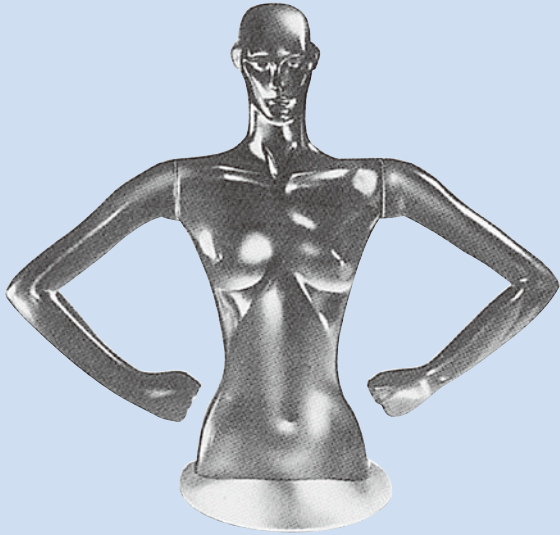

HF573-B
Ladies' - Black

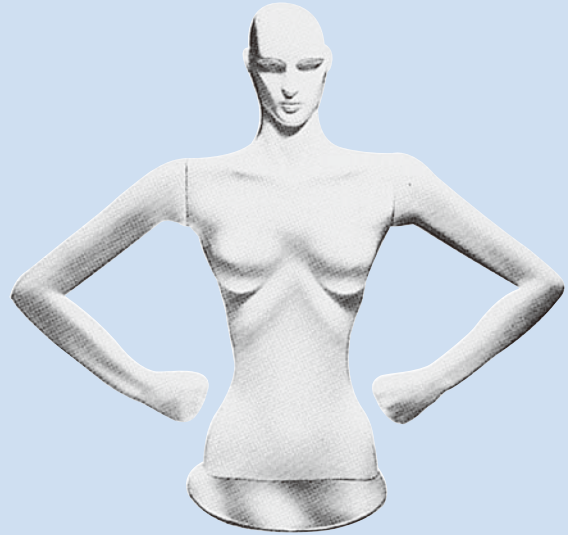

HF573-W
Ladies' - White

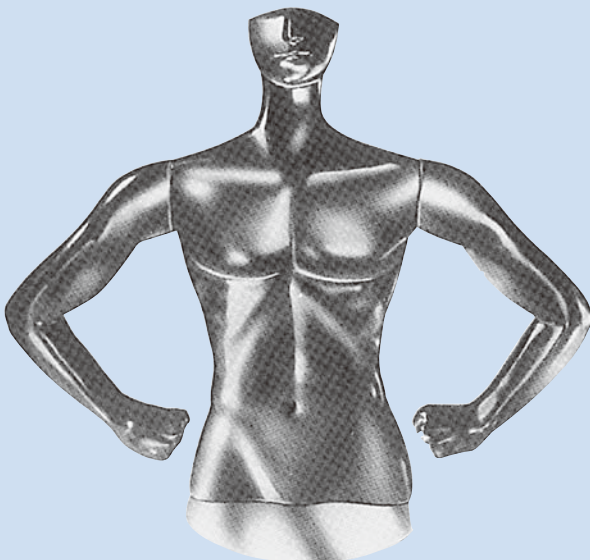

HF577-B
Men's - Black

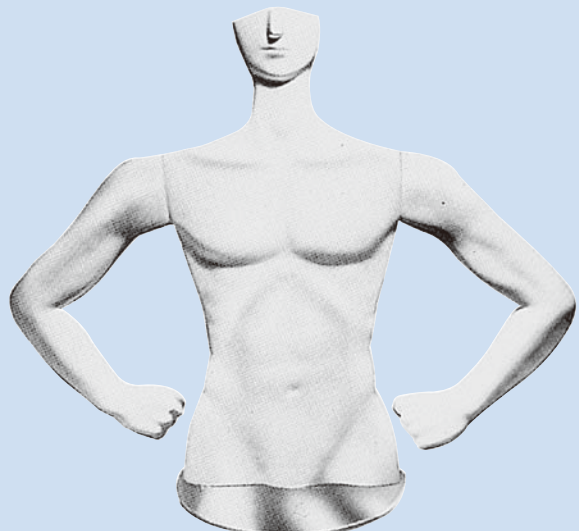

HF577-W
Men's - White



HAND-PAINTED FLAT MANNEQUINS

Made of fiberglass only 1-3/16" thick. Have three-dimensional faces and bodies. Lightweight and sturdy they feature hand painted faces and mod hair. Stands on a 15-1/2" round chrome base.

Available in three poses. Height: 73".

White color



FF70



FF71



FF72



FF40

FF41

FF42



LADIE'S FLAT MANNEQUINS

Made of fiberglass, fleshtone with make-up. Only 2 inches in depth. Each figure is 73 inches tall and stands on 15-1/2 inch round chrome base (included).

Available in 3 poses.

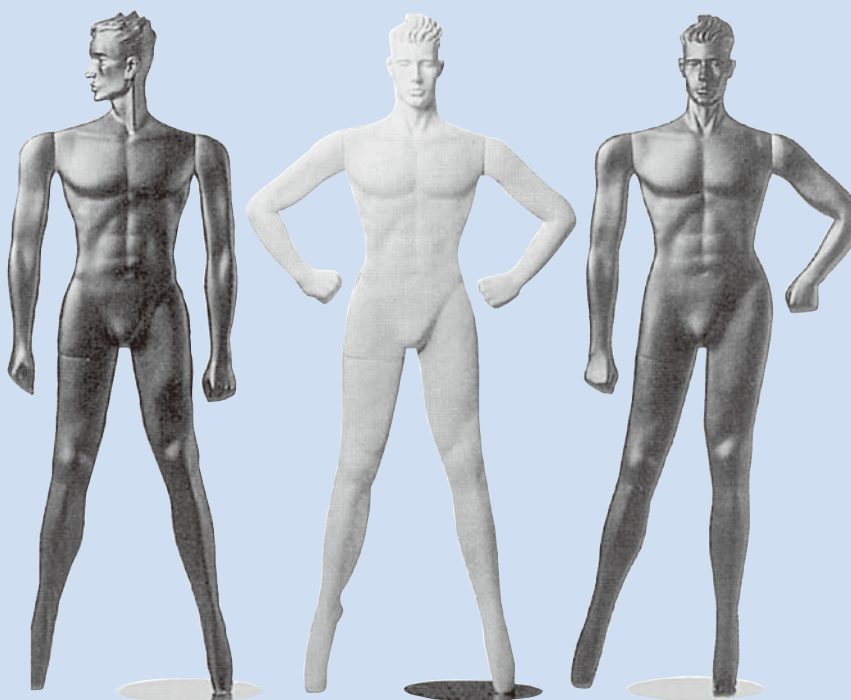

FF43-B - Black
FF43-W - White

FF44-B - Black
FF44-W - White

FF45-B - Black
FF45-W - White

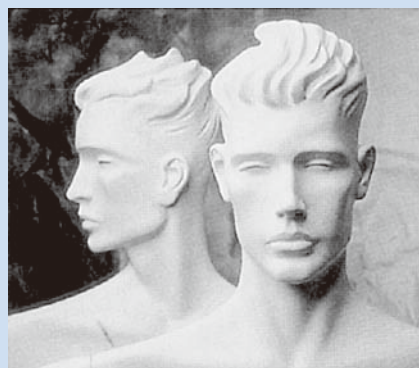

MAN'S FLAT MANNEQUINS

Made of fiberglass, Black or White Only 2 inches in depth. Each figure is 75 inches tall and stands on 15-1/2 inch round chrome base (included).

Available in 3 poses.



FLEXIBLE FORMS

Made of Ribbed Rubber Flexible Aluminum Rod - Black

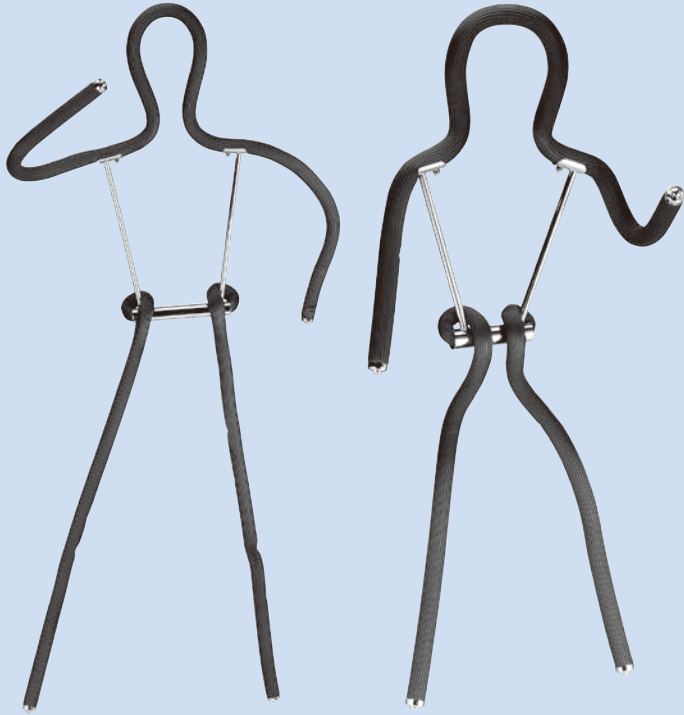

Ribbed Rubber Flexible Form - Black

Can be shaped into any position and hung from cord or wire. Form has 3/8" fitting for mounting to "T" stand.

- # RFAD - Adult
- # RFCH - Child



"T" Stand

8" chrome base with 36" to 72" adjustable upright.

836

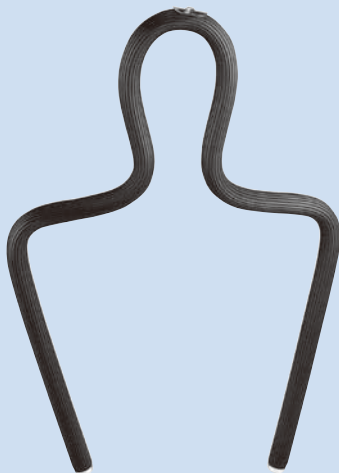

6 Ft. Ribbed Rubber Flexible Aluminum Rod - Black

Let your imagination run wild. Can be shaped into any form.

RF6



HEADLESS MALE MANNEQUINS

- Fiberglass construction
- Three different poses
- Round metal base connected to sole
- Fleshtone & white colors are available



MSM-604
MSM-604-W
 H : 172.0 cm
 B : 96.0 cm
 W : 77.0 cm
 Hi : 95.0 cm



MSM-605
MSM-605-W
 H : 170.0 cm
 B : 97.5 cm
 W : 76.0 cm
 Hi : 92.0 cm

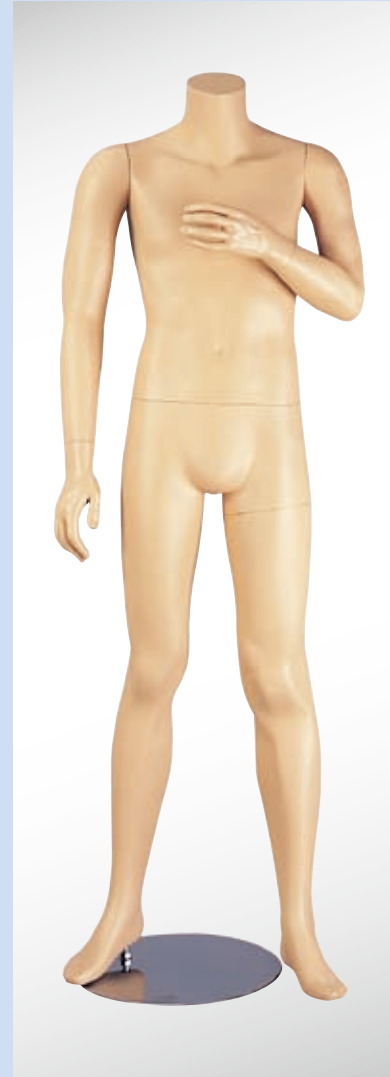

MSM-606
MSM-606-W
 H : 172.0 cm
 B : 96.0 cm
 W : 77.0 cm
 Hi : 95.0 cm



HEADLESS FEMALE MANNEQUINS

- Fiberglass construction
- Four different poses
- Round metal base connected to sole
- Fleshtone & white colors are available

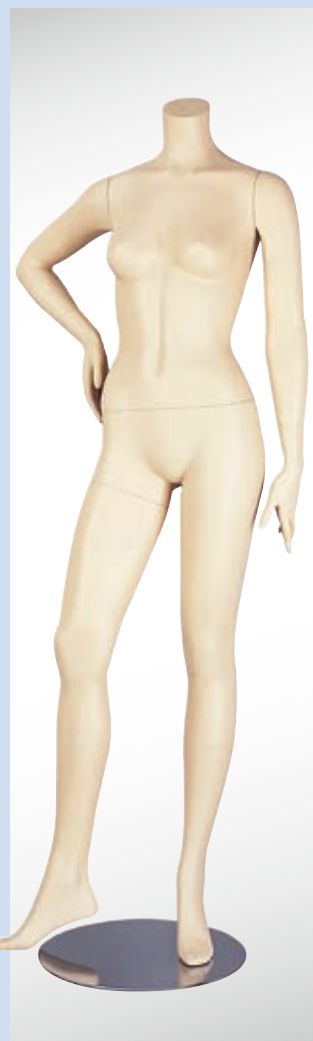
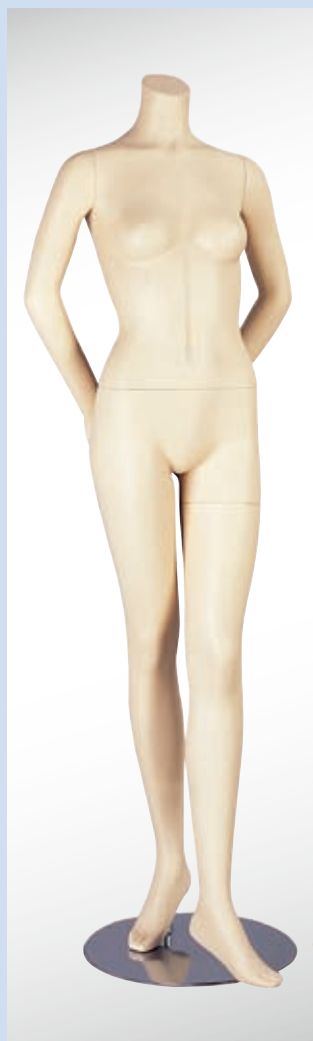
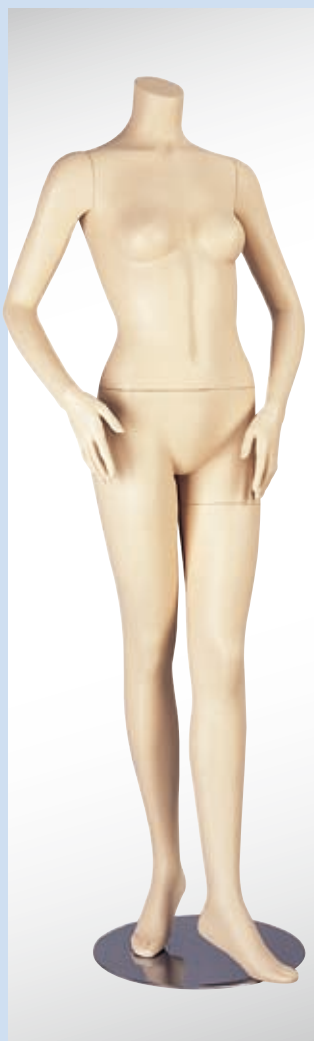
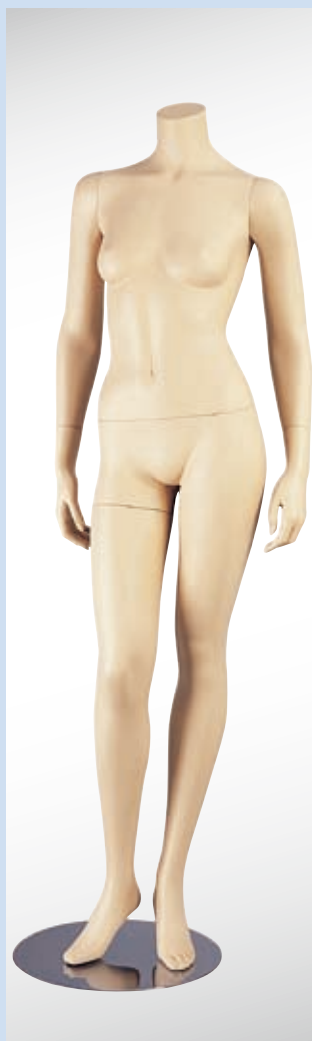

DYM-63
DYM-63-W

H : 165.0 cm
B : 85.0 cm
W : 63.0 cm
Hi : 86.0 cm

DYM-64
DYM-64-W

H : 165.0 cm
B : 85.0 cm
W : 63.0 cm
Hi : 86.0 cm

DYM-65
DYM-65-W

H : 165.0 cm
B : 85.0 cm
W : 63.0 cm
Hi : 86.0 cm

DYM-66
DYM-66-W

H : 165.0 cm
B : 85.0 cm
W : 63.0 cm
Hi : 86.0 cm



MALE MANNEQUINS

- Fiberglass construction
- Molded hair
- Round metal base connected to sole

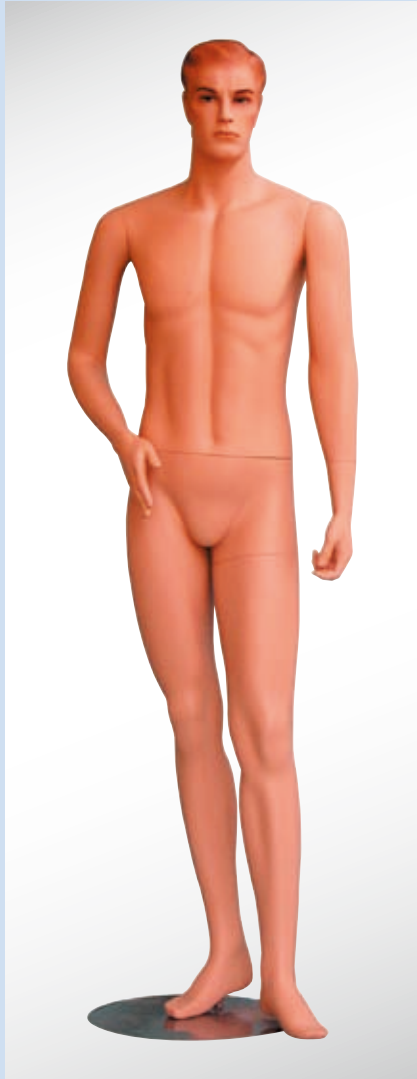

EA-4-1
 Flestone color
 Make-up
 H : 183.0 cm
 B : 95.3 cm
 W : 77.0 cm
 Hi : 91.0 cm

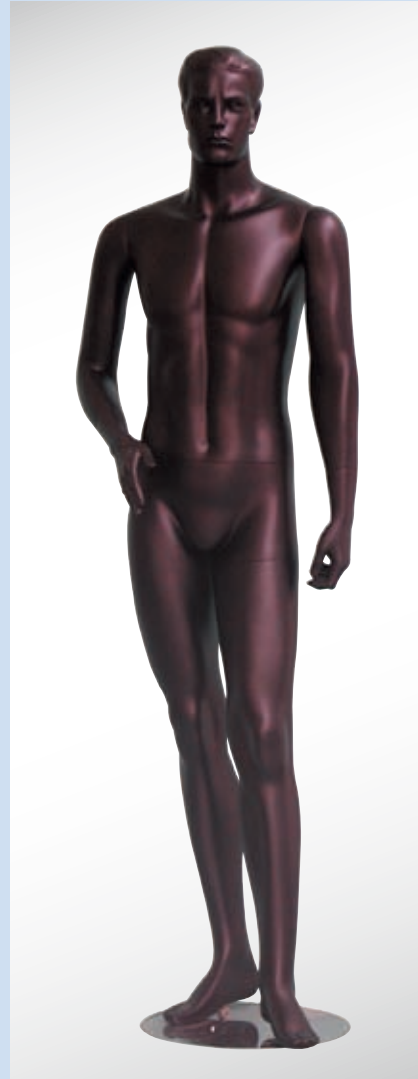

EA-4B-2
 Black color
 Without Make-up
 H : 182.8 cm
 B : 95.5 cm
 W : 77.5 cm
 Hi : 91.0 cm



ETHNIC MANNEQUINS

- African-American with make-up
- Fiberglass construction
- Molded hair
- Dark brown color
- Round metal base connected to sole



DYL-200B-1

Male

H : 186.0 cm

B : 98.0 cm

W : 78.5 cm

Hi : 95.0 cm

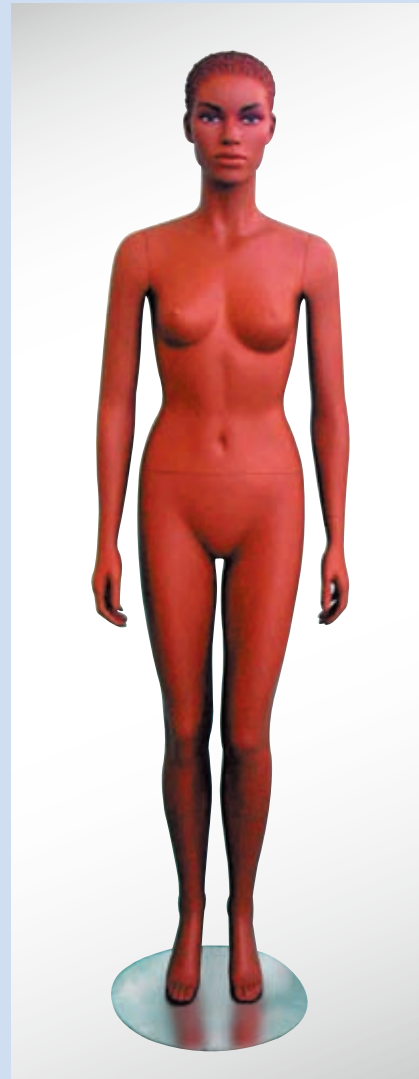

DYM-100B-1

Female

H : 181.0 cm

B : 85.5 cm

W : 61.5 cm

Hi : 87.50 cm



BOY MANNEQUINS

- Fiberglass construction
- Fleshtone color
- Molded hair
- Make-up
- Round metal base connected to sole

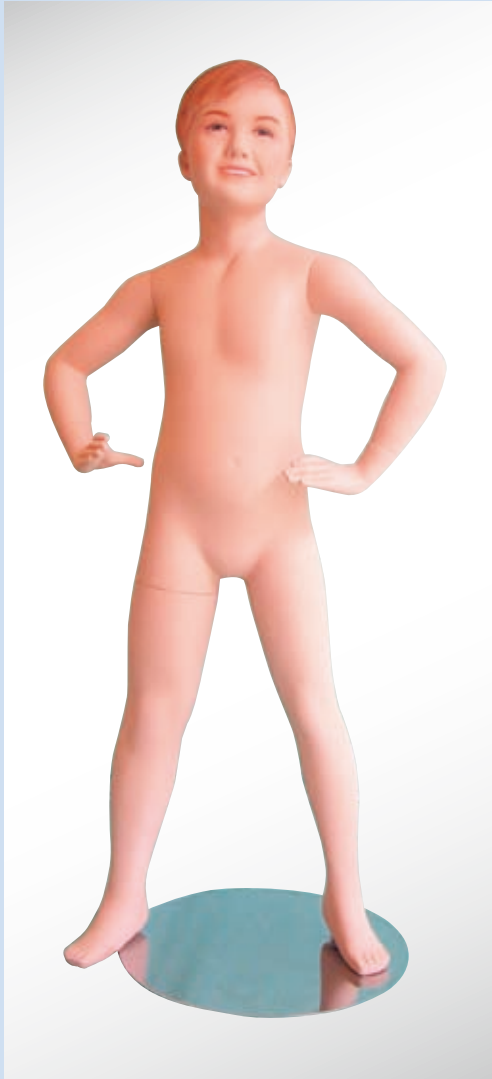

KY-719C-2

H : 100.6 cm
 B : 57.0 cm
 W : 52.0 cm
 Hi : 63.5 cm

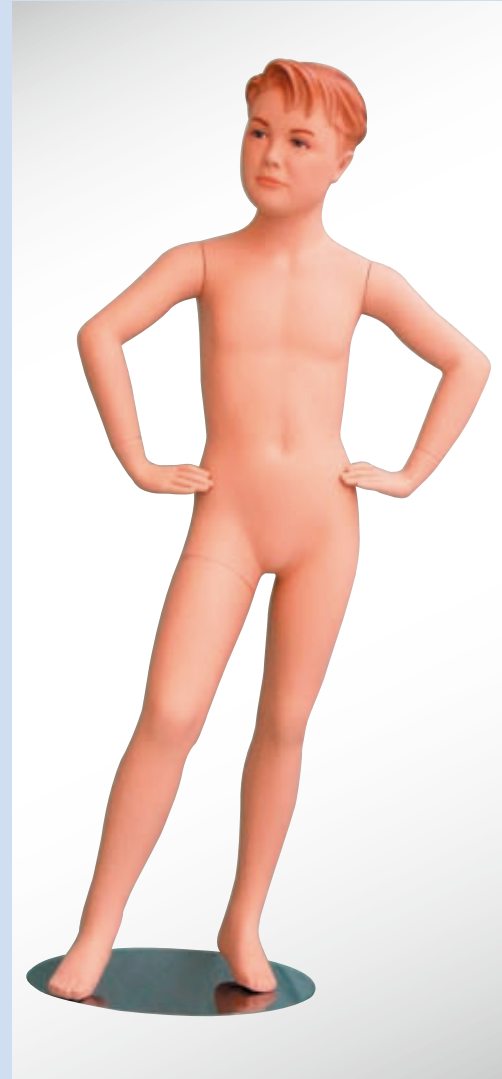

KY-723C-2

H : 127.0 cm
 B : 62.7 cm
 W : 52.0 cm
 Hi : 66.5 cm



GIRL MANNEQUINS

- Fiberglass construction
- Fleshtone color
- Molded hair
- Make-up
- Round metal base connected to sole

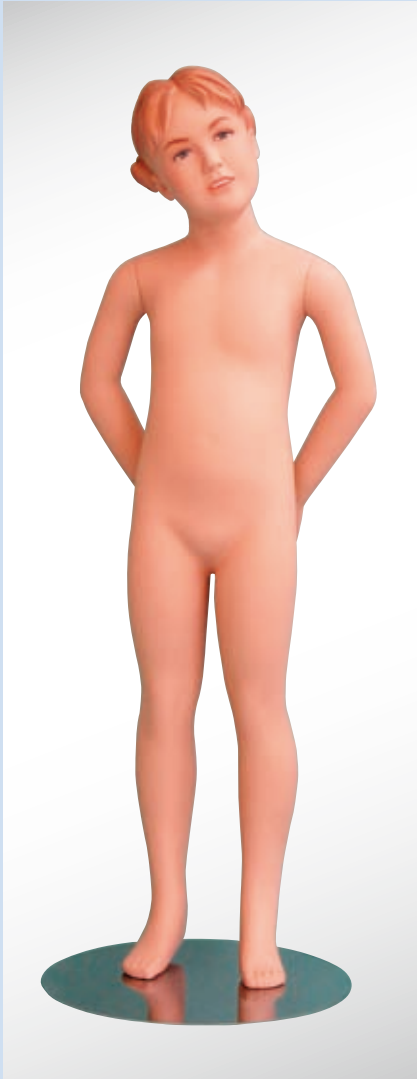

KY-720C-2

H : 115.0 cm
B : 57.5 cm
W : 51.5 cm
Hi : 63.0 cm

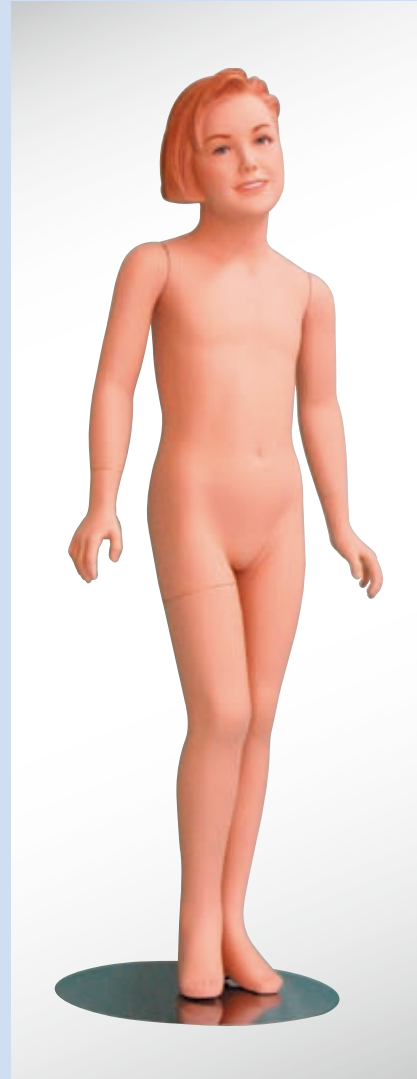

KY-724C-2

H : 127.5 cm
B : 61.3 cm
W : 51.6 cm
Hi : 65.5 cm



FEMALE MANNEQUINS

- Fiberglass construction
- Molded hair
- Make-up
- Round metal base connected to sole

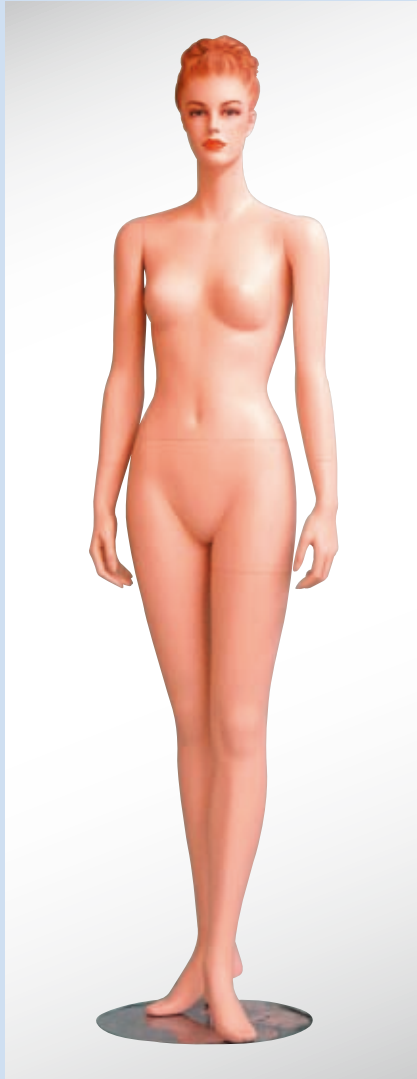

L-4-1C-2
Fleshtone color
H : 180.0 cm
B : 82.5 cm
W : 57.5 cm
Hi : 87.0 cm

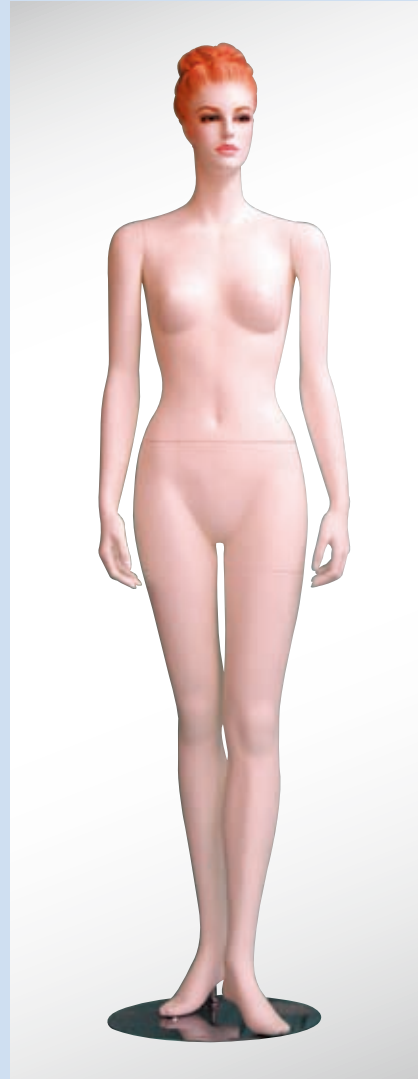

L-4W-2
White color
H : 180.0 cm
B : 82.5 cm
W : 57.5 cm
Hi : 87.0 cm



FEMALE MANNEQUINS

- Fiberglass construction
- Fleshtone color
- Molded hair
- Make-up
- Round metal base connected to sole



S-627C-2
H : 180.0 cm
B : 82.0 cm
W : 60.5 cm
Hi : 87.0 cm

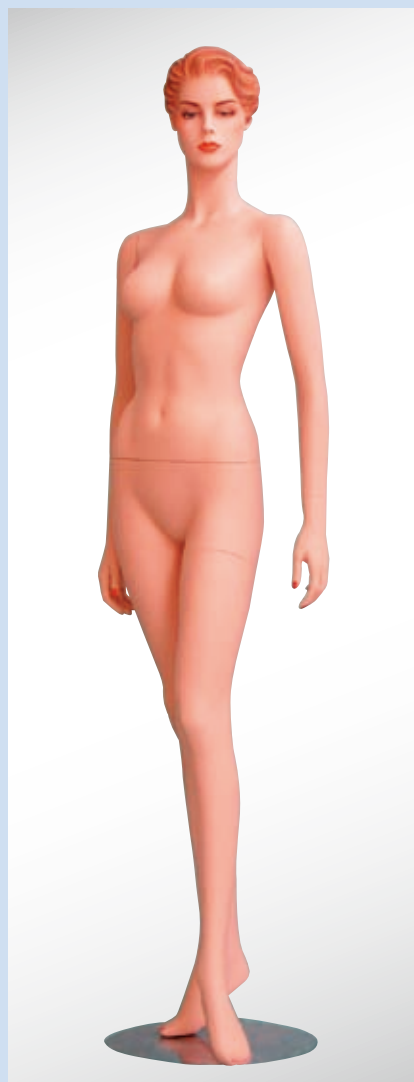

S-630C-2
H : 181.0 cm
B : 82.5 cm
W : 58.0 cm
Hi : 87.0 cm



FEMALE MANNEQUINS

- Fiberglass construction
- Fleshtone color
- Molded hair
- Make-up
- Round metal base connected to sole

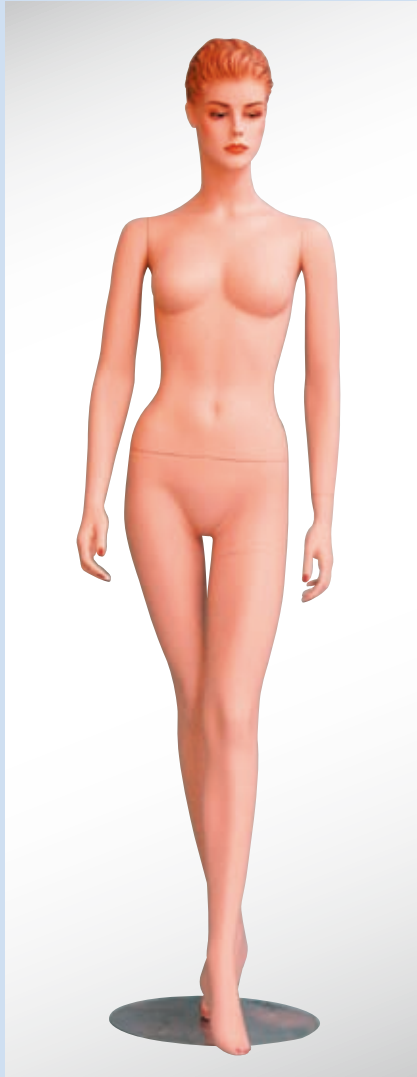

S-631C-2

H : 181.5 cm
B : 83.0 cm
W : 58.5 cm
Hi : 88.0 cm

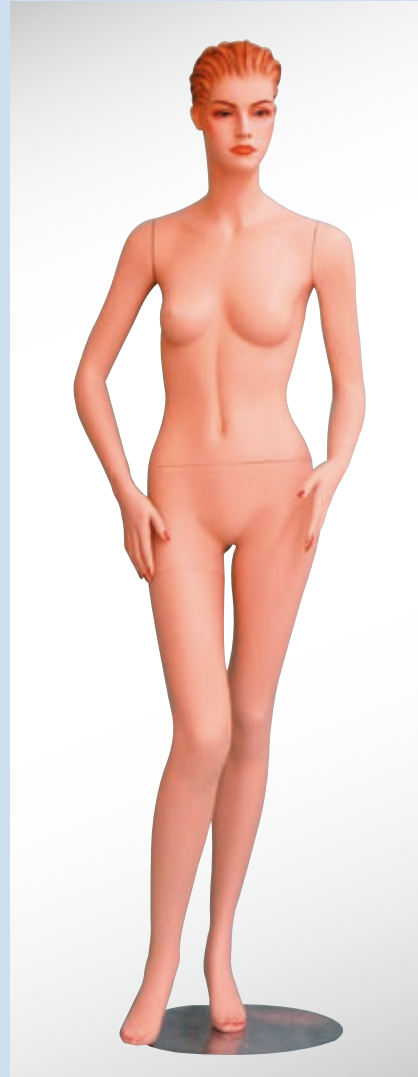

S-633C-2

H : 178.0 cm
B : 81.7 cm
W : 59.5 cm
Hi : 87.0 cm



FEMALE MANNEQUINS

- Fiberglass construction
- Fleshtone color
- Molded hair
- Make-up
- Round metal base connected to sole

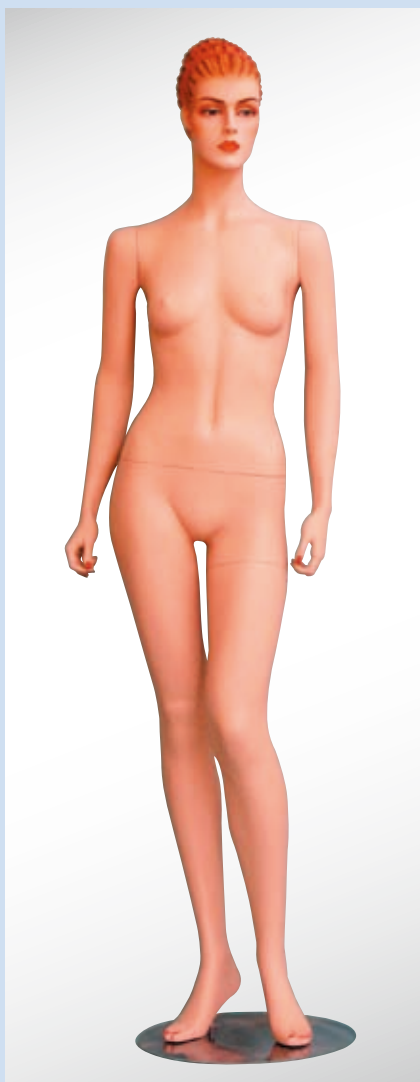

S-634C-2

H : 180.0 cm

B : 82.7 cm

W : 61.5 cm

Hi : 88.5 cm

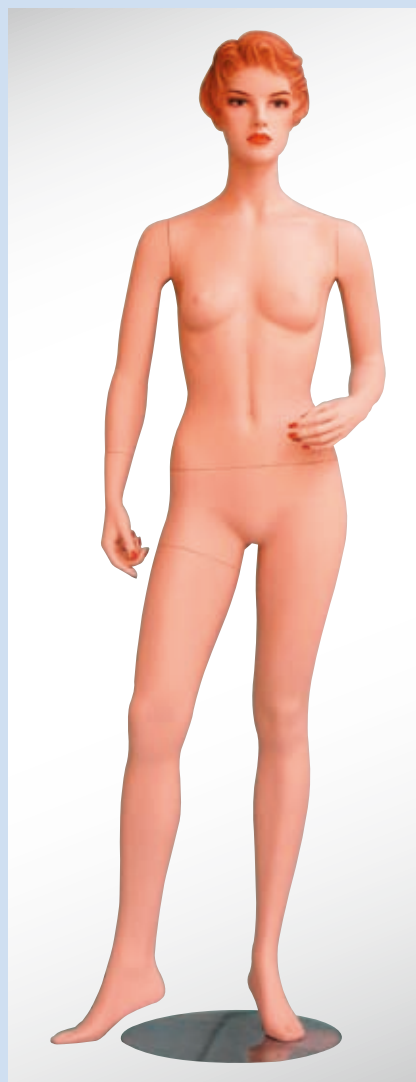

S-642C-2

H : 178.0 cm

B : 82.7 cm

W : 61.3 cm

Hi : 87.0 cm



FEMALE MANNEQUINS

- Fiberglass construction
- Fleshtone color
- Short wig
- Make-up
- Round metal base connected to sole

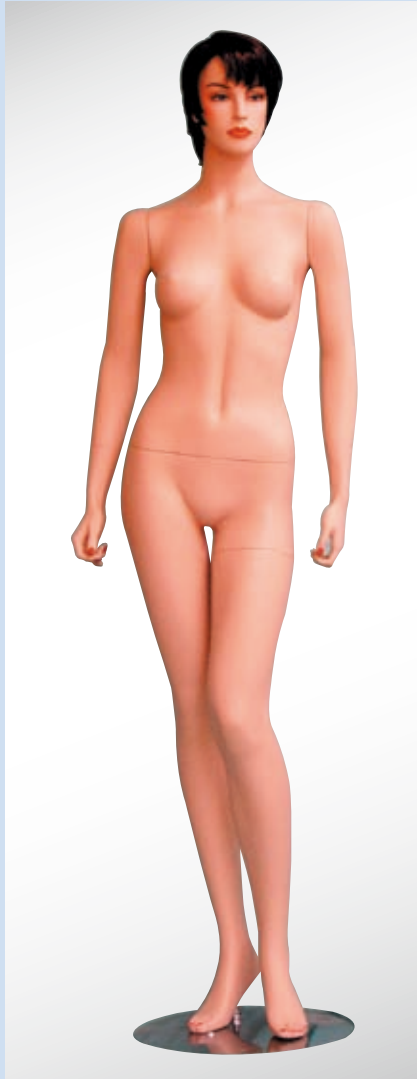

EA-161C (Without wig)

EA-161C-3 (With wig)

H : 178.0 cm

B : 86.5 cm

W : 62.0 cm

Hi : 88.0 cm

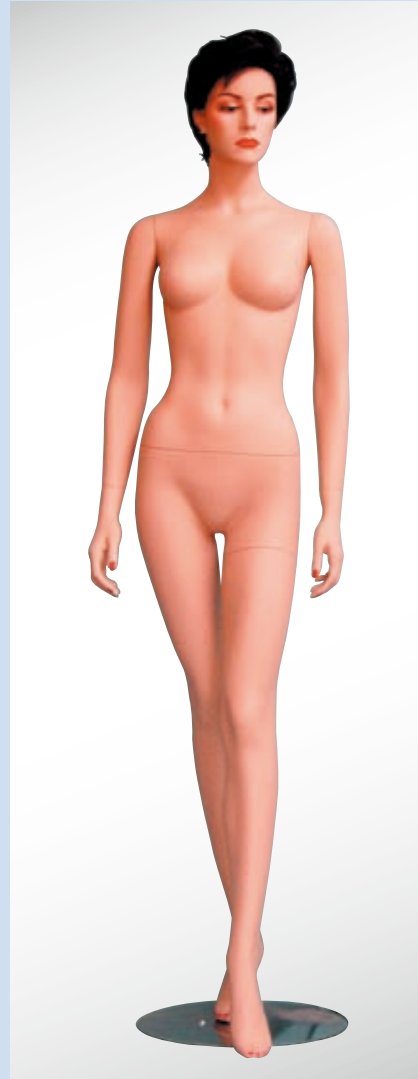

KY-146C (Without wig)

KY-146C-3 (With wig)

H : 180.0 cm

B : 82.5 cm

W : 59.0 cm

Hi : 87.0 cm



FEMALE MANNEQUINS

- Fiberglass construction
- Fleshtone color
- Long wig
- Make-up
- Round metal base connected to sole

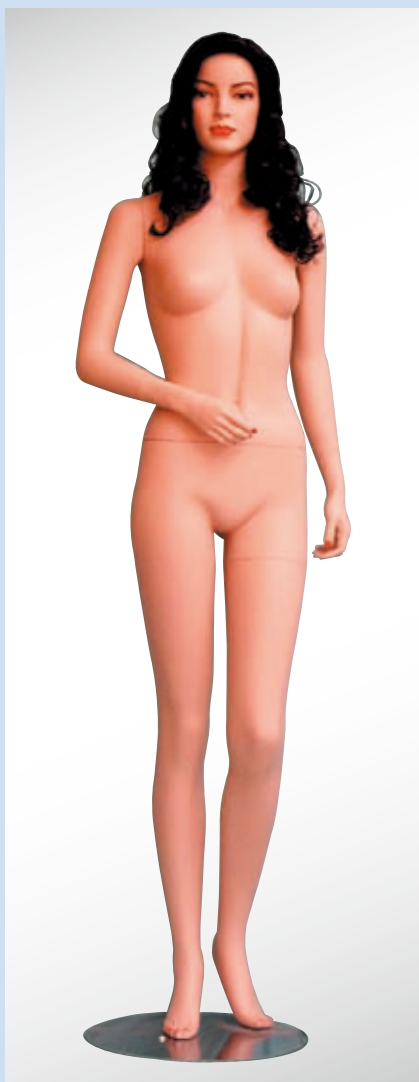

EA-165C (Without wig)

EA-165C-3 (With wig)

H : 178.0 cm

B : 84.5 cm

W : 61.5 cm

Hi : 87.0 cm

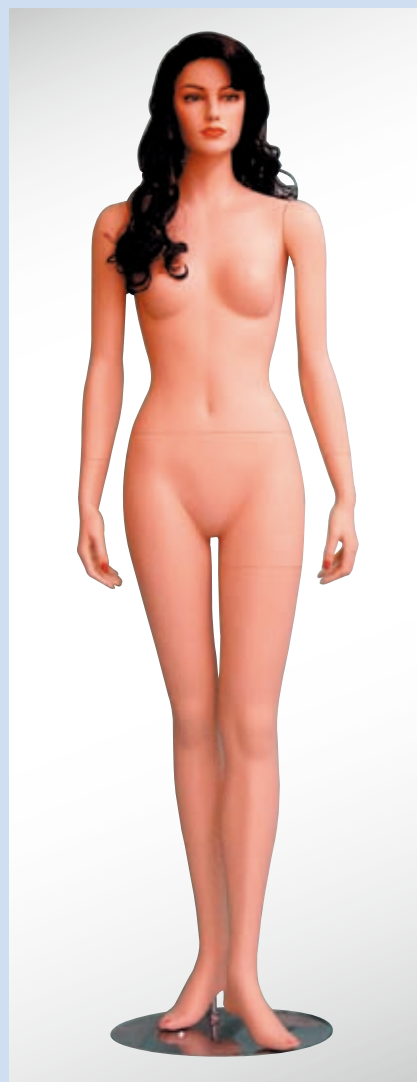

L-4-1C (Without wig)

L-4-1C-3 (With wig)

H : 176.5 cm

B : 82.5 cm

W : 57.5 cm

Hi : 86.0 cm



FEMALE MANNEQUINS

- Fiberglass construction
- Fleshtone color
- Molded hair
- Make-up
- Round metal base connected to sole



OP1-01

H : 178.0 cm
B : 83.5 cm
W : 61.0 cm
Hi : 88.0 cm

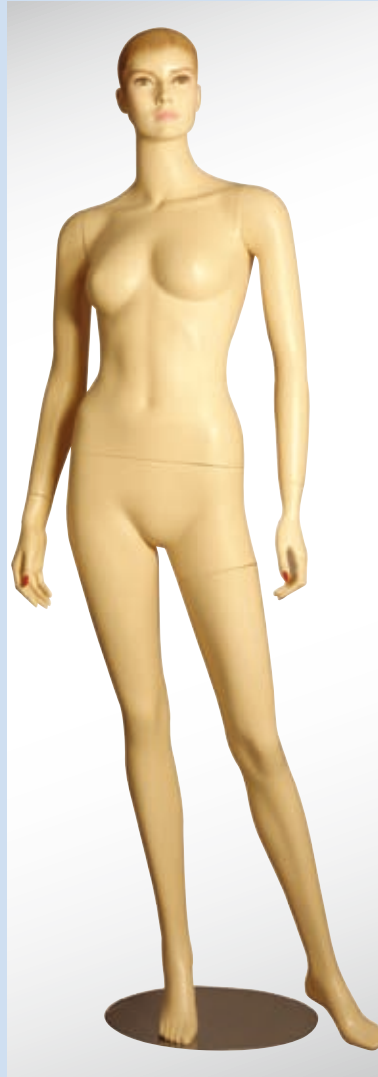

OP1-02

H : 178.0 cm
B : 82.5 cm
W : 60.5 cm
Hi : 87.5 cm

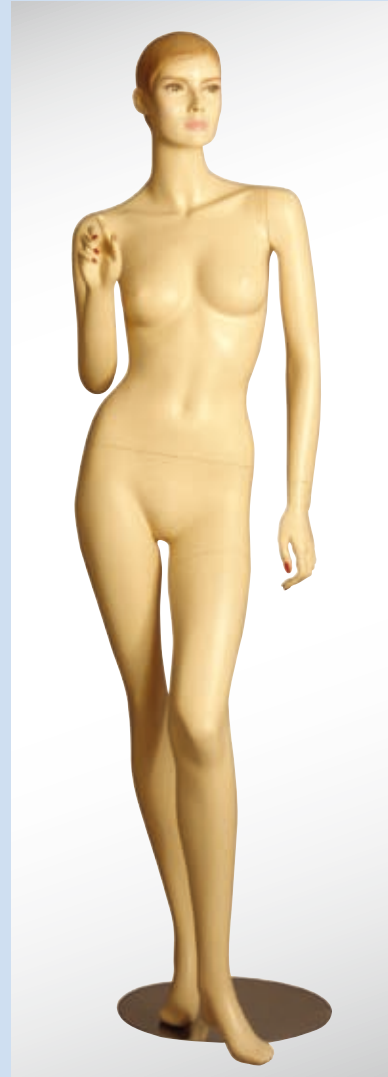

OP1-03

H : 178.0 cm
B : 80.0 cm
W : 61.0 cm
Hi : 88.0 cm



FEMALE MANNEQUINS

- Fiberglass construction
- Fleshtone color
- Molded hair
- Make-up
- Round metal base connected to sole

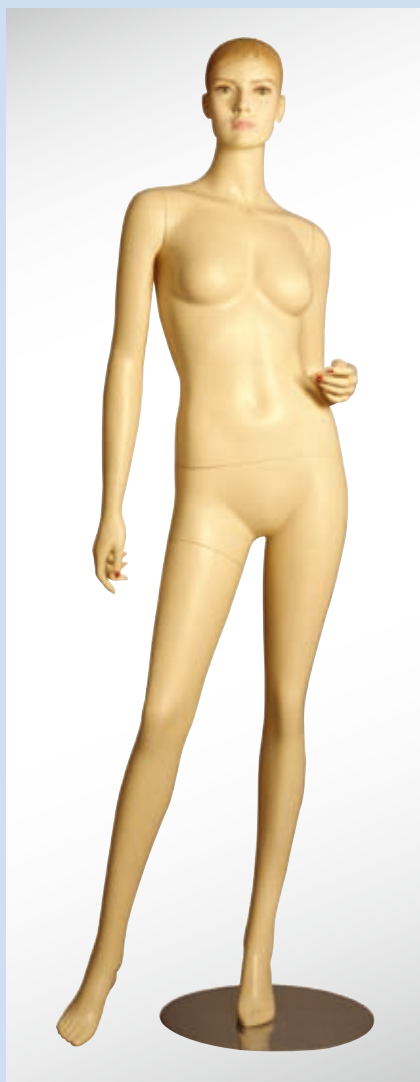

OP1-04

H : 178.0 cm
B : 81.5 cm
W : 60.0 cm
Hi : 88.5 cm

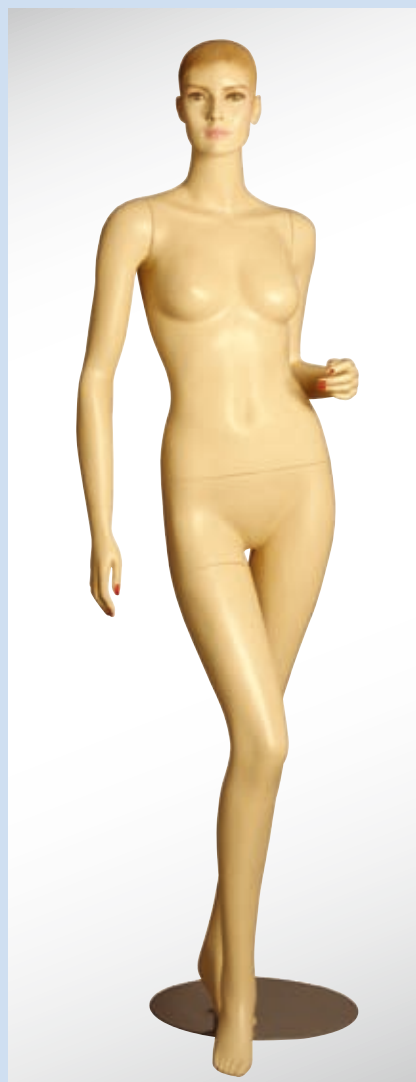

OP1-05

H : 177.0 cm
B : 82.0 cm
W : 58.5 cm
Hi : 88.0 cm



MALE MANNEQUINS

- Fiberglass construction
- Fleshtone color
- Molded hair
- Make-up
- Round metal base connected to sole



OP2-01

H : 182.0 cm
 B : 99.0 cm
 W : 82.0 cm
 Hi : 94.0 cm

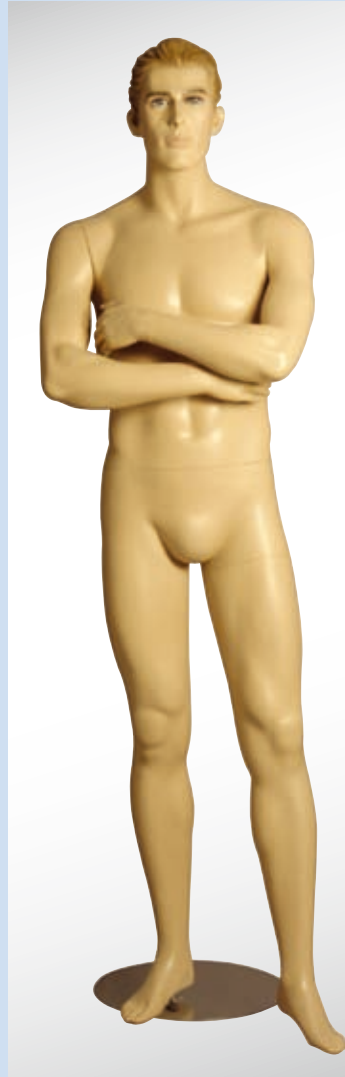

OP2-02

H : 182.0 cm
 B : 96.0 cm
 W : 80.0 cm
 Hi : 94.0 cm

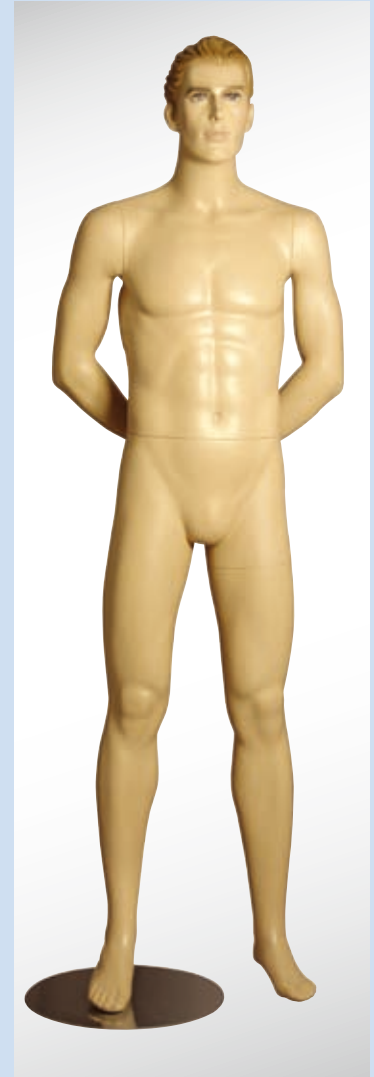

OP2-03

H : 185.0 cm
 B : 96.5 cm
 W : 79.0 cm
 Hi : 94.5 cm



MALE MANNEQUINS

- Fiberglass construction
- Fleshtone color
- Molded hair
- Make-up



● Round metal base connected to sole

OP2-04

H : 180.0 cm
B : 97.0 cm
W : 80.0 cm
Hi : 94.0 cm



OP2-05

H : 185.0 cm
B : 96.0 cm
W : 80.0 cm
Hi : 94.0 cm



● Round metal base and stool not included

OP2-06

H : 153.0 cm
B : 96.0 cm
W : 77.5 cm
Hi : 90.0 cm



FEMALE TEENAGE MANNEQUINS

- Fiberglass construction
- Fleshtone color
- Molded hair
- Make-up
- Round metal base connected to sole



OP3-01

H : 167.0 cm
 B : 75.0 cm
 W : 59.0 cm
 Hi : 82.0 cm

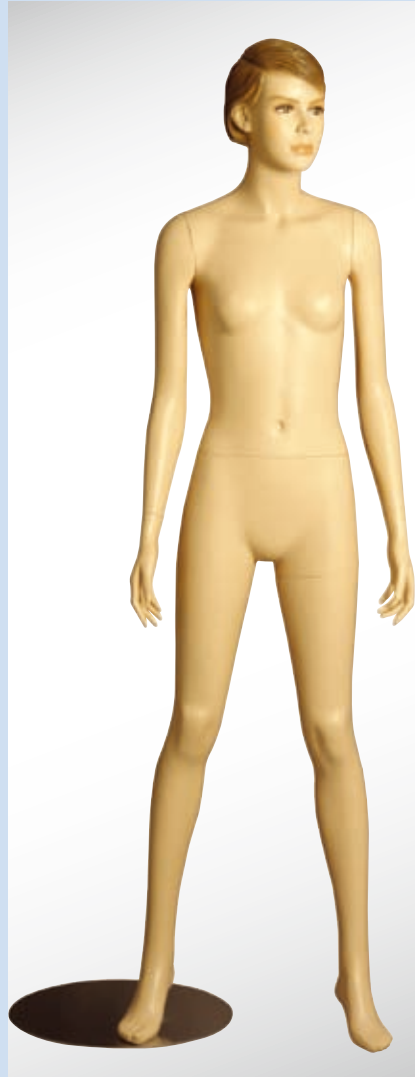

OP3-02

H : 165.0 cm
 B : 77.0 cm
 W : 59.0 cm
 Hi : 83.5 cm

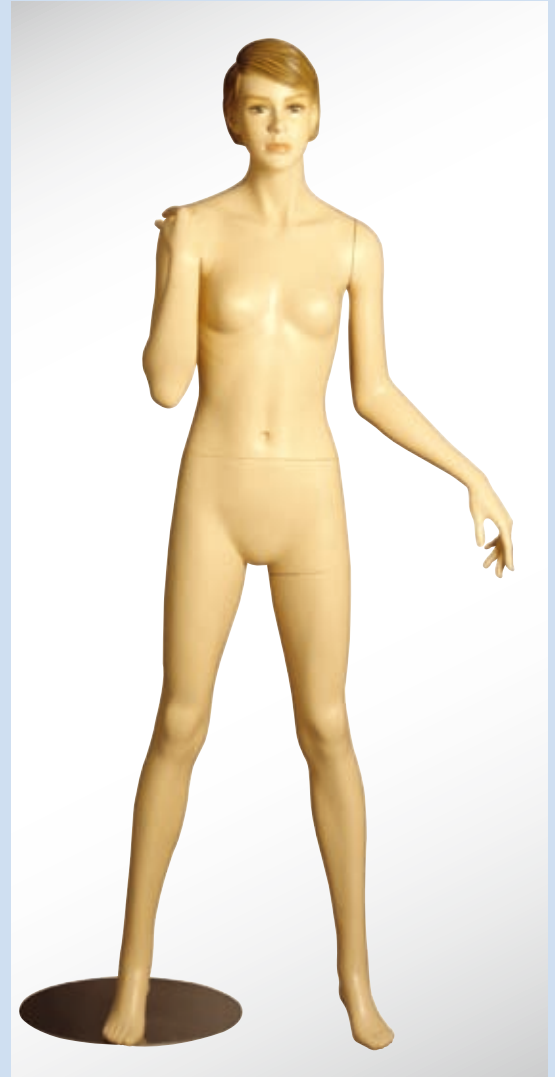

OP3-03

H : 165.0 cm
 B : 74.5 cm
 W : 58.5 cm
 Hi : 82.0 cm



MALE TEENAGE MANNEQUINS

- Fiberglass construction
- Fleshtone color
- Molded hair
- Make-up
- Round metal base connected to sole



OP4-01

H : 170.0 cm
B : 84.0 cm
W : 70.0 cm
Hi : 89.0 cm



OP4-02

H : 170.0 cm
B : 85.0 cm
W : 69.5 cm
Hi : 89.5 cm



OP4-03

H : 169.0 cm
B : 86.0 cm
W : 73.0 cm
Hi : 88.0 cm



CHILDREN'S MANNEQUINS

- Fiberglass construction
- Fleshtone color
- Molded hair
- Make-up
- Round metal base connected to sole



OP5-01

H : 140.0 cm
 B : 67.5 cm
 W : 56.5 cm
 Hi : 68.5 cm



OP5-02

H : 124.0 cm
 B : 62.0 cm
 W : 50.5 cm
 Hi : 61.0 cm



OP5-03

H : 123.0 cm
 B : 64.0 cm
 W : 54.5 cm
 Hi : 62.0 cm



HEADLESS MALE MANNEQUINS

- Fiberglass construction
- White color
- Round metal base connected to sole

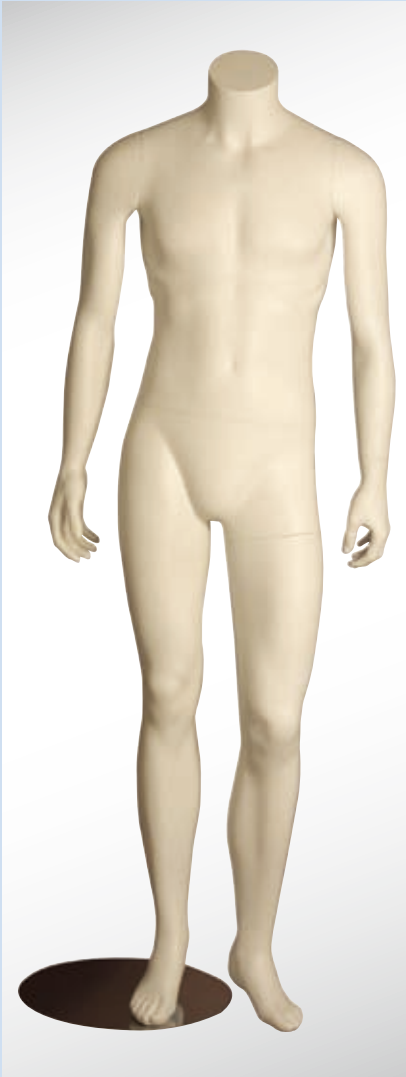

OP6-01

H : 167.5 cm
B : 97.5 cm
W : 76.5 cm
Hi : 95.0 cm

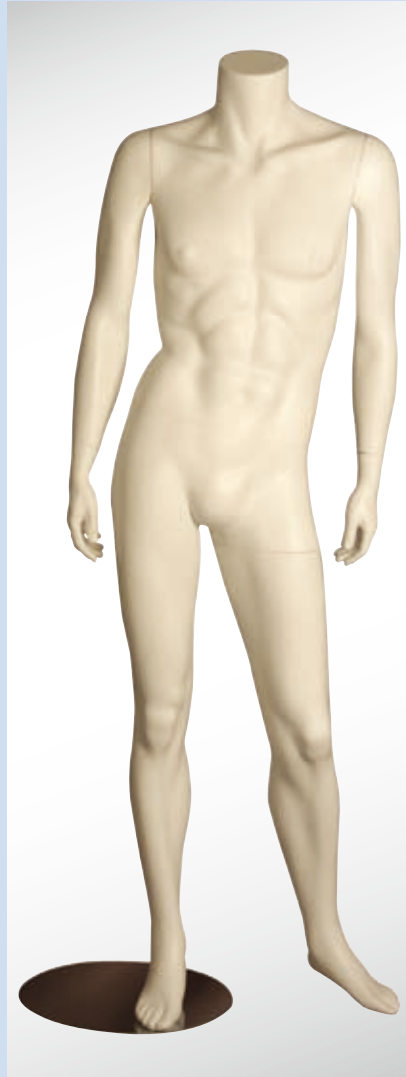

OP6-02

H : 171.0 cm
B : 99.0 cm
W : 77.0 cm
Hi : 96.0 cm

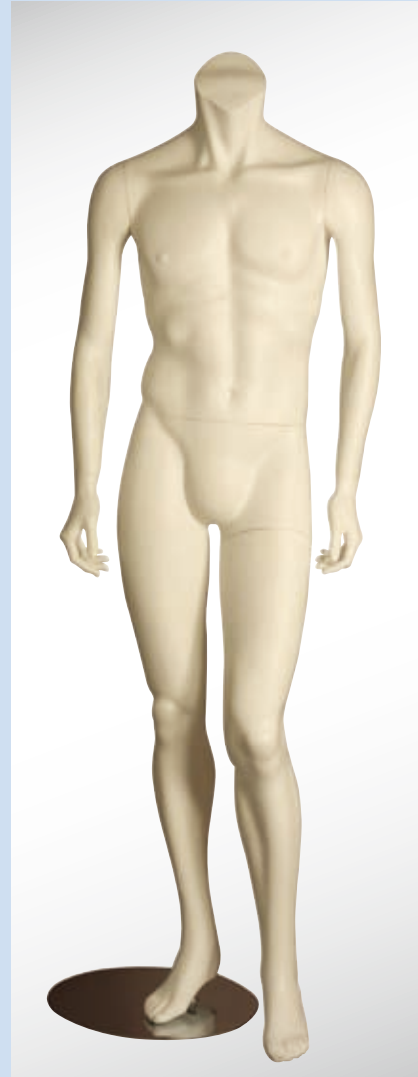

OP6-03

H : 172.5 cm
B : 98.0 cm
W : 78.0 cm
Hi : 94.5 cm



HEADLESS FEMALE MANNEQUINS

- Fiberglass construction
- White color
- Round metal base connected to sole

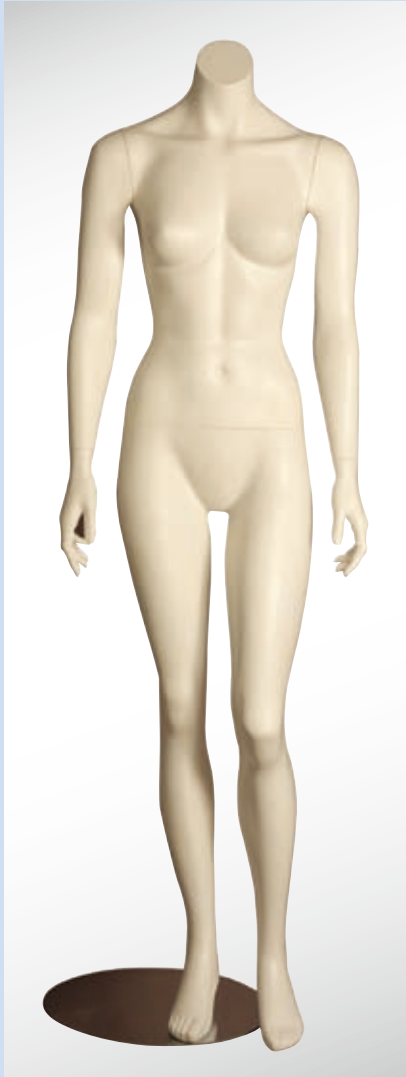

OP7-01

H : 162.5 cm
 B : 86.0 cm
 W : 58.5 cm
 Hi : 88.0 cm

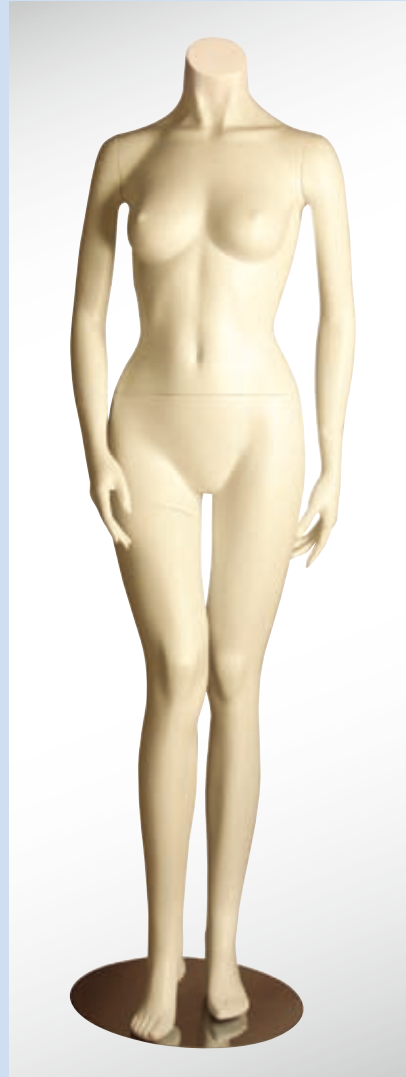

OP7-02

H : 164.0 cm
 B : 87.0 cm
 W : 63.0 cm
 Hi : 92.0 cm

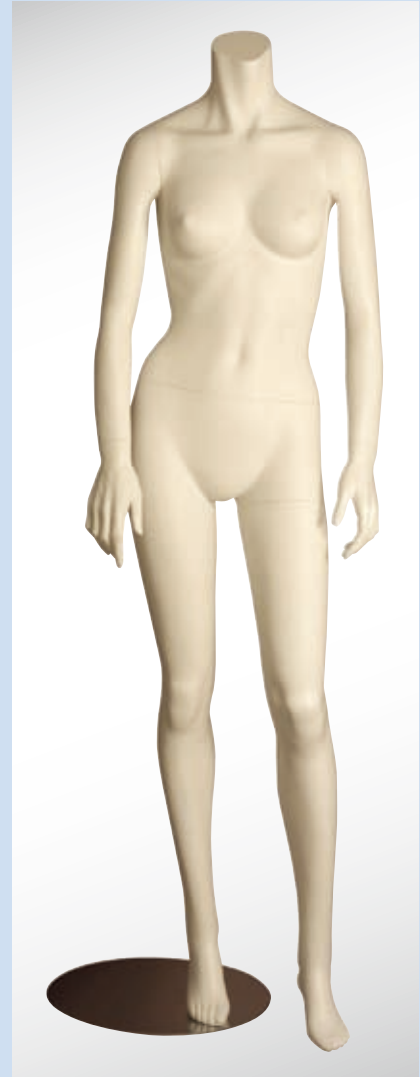

OP7-03

H : 166.0 cm
 B : 85.5 cm
 W : 63.0 cm
 Hi : 90.5 cm

TUBULAR COMPONENTS FOR TUBULAR MANNEQUINS

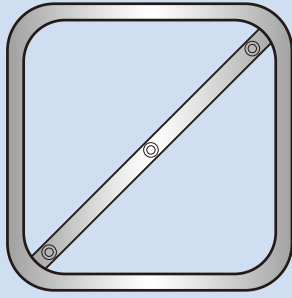

TK1B
Uni-Base
Holds 1, 2, or 3 Displayers

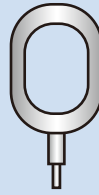

TK7H
Head Accessory

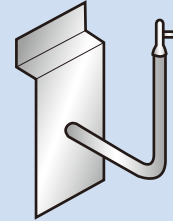

TK11P
Slatwall Bracket

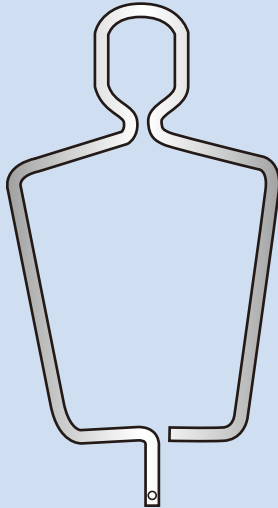

TK2F
Body Form

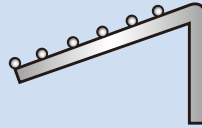

TK8W
Waterfall Displayer

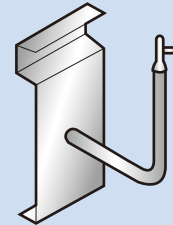

TK12P
Gridwall Bracket



TK9T
42" Cross Piece for "T" Top

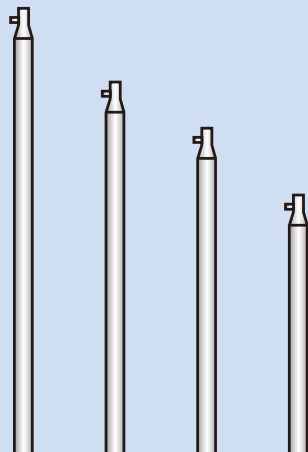

TK3U 25" Upright
TK4U 35" Upright
TK5U 48" Upright
TK6U 58" Upright

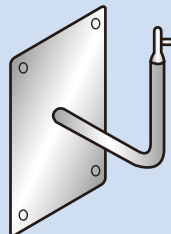

TK10P
Wall-Mount Bracket



TK13U
**25" Upright For
Wall-Mount Bracket**

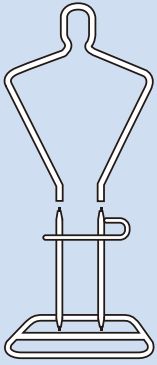

> Tubular Form with Slack/Skirt Bar

Display a complete outfit, draping over the removable valet bar. Two sets of legs for floor or countertop use. 68" high, 15" sq. base.

- # TQ1W White
- # TQ1B Black
- # TQ1R Red

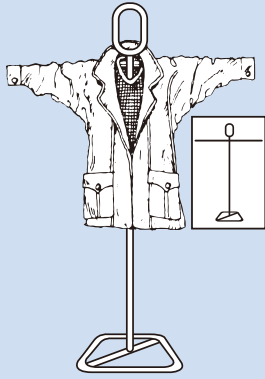

Single T Displayer With Head

74" high, 42" wide T bar, 18" sq. base.

- # TQ3W White
- # TQ3B Black
- # TQ3R Red



Single Form Displayer

58" high, 18" sq. base

- # TQ6W White
- # TQ6B Black
- # TQ6R Red

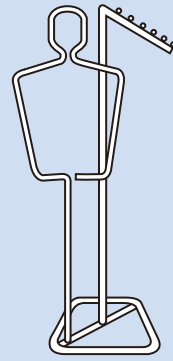

Single Form & Displayer Waterfall

58" & 56" high, 18" sq. base.

- # TQ9W White
- # TQ9B Black
- # TQ9R Red

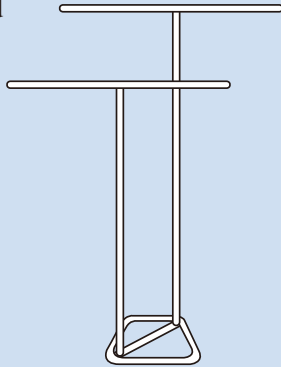

Double T displayer

54" & 64" high, Two 42" T bars

- # TQ4W White
- # TQ4B Black
- # TQ4R Red

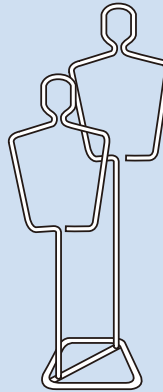

Double Form Displayer

58" & 68" high, 18" sq. base.

- # TQ7W White
- # TQ7B Black
- # TQ7R Red



Wall Mount Display Form

- # TQ10W White
- # TQ10B Black
- # TQ10R Red

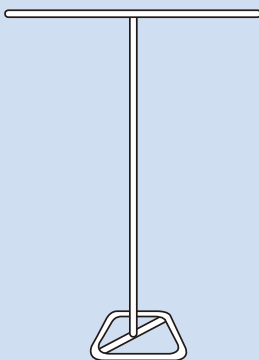

Single T Displayer

64" high, 42" wide, 18" sq. base.

- # TQ2W White
- # TQ2B Black
- # TQ2R Red

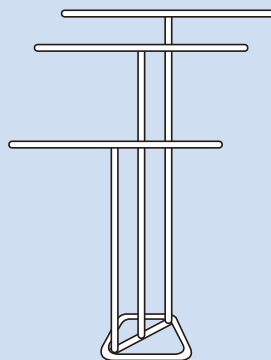

Triple T Displayer

3-42" T displayers, 41", 54" & 64" high.

- # TQ5W White
- # TQ5B Black
- # TQ5R Red

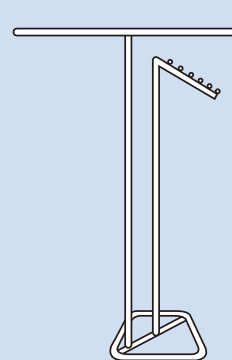

Single T & Waterfall Displayer

56" & 64" high, 18" sq. base.

- # TQ8W White
- # TQ8B Black
- # TQ8R Red

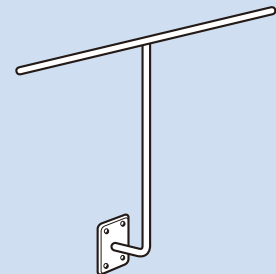

Wall Mount T Displayer

28" High, 42" Wide.

- # TQ13W White
- # TQ13B Black
- # TQ13R Red

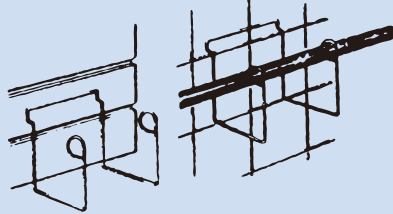
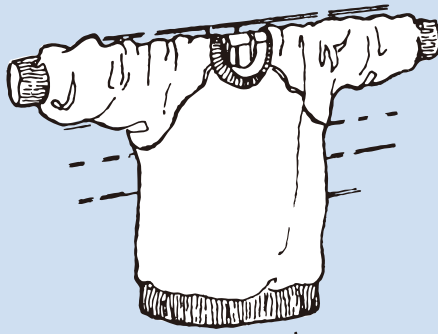

"Scarecrow" Wall Displayer

Fits Slatwall or Gridwall. Put together in seconds- Just slip bar through rings. 42" long, all chrome plated

TKGS4

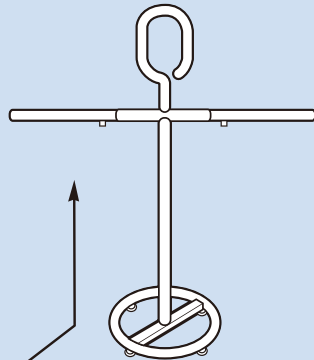

Scarecrow Displayer

TK30F-W White

TK30F-B Black

TK30F-R Red

- Place these on counters for attention getting displays.
- Unit comes with 36" crossbar for scarecrow display or crossbar display.
- Can be removed and substituted with flexible arms for arranging arms in different positions.
- Unit is constructed of 1 1/4" round tubing. 36" high with 12" diameter base.
- Durable powder epoxy coated

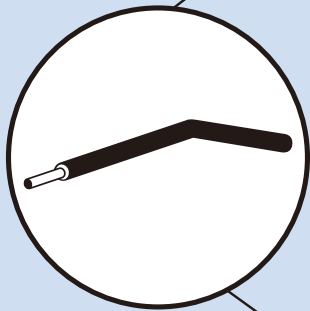

Flexible Arm

Ribbed rubber flexible arm can be switched with rigid snap out arm.

FLX2 Black

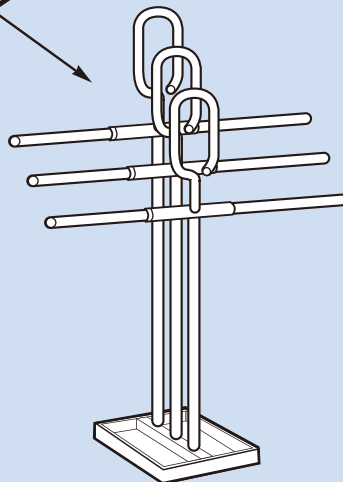

Scarecrow Displayer

TK33F-W White

TK33F-B Black

TK33F-R Red

- Unit comes with 36" crossbar for scarecrow display or crossbar display.
- Can be removed and substituted with flexible arms for arranging arms in different positions.
- Unit is constructed for 1 1/4" round tubing, 40", 46" & 52" high with 12" square base.
- Durable powder epoxy coated



MENS TORSO FORM

H : 110 cm
B : 103 cm
W : 80 cm
Hi : 97 cm
AS100

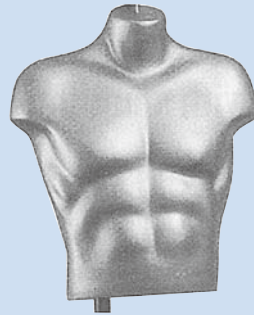

MENS MUSCULAR SHIRT FORM

H : 57 cm
B : 103 cm
W : 80 cm
AS101



MENS TRUNK FORM

H : 60 cm
Hi : 97 cm
AS102



MENS SHIRT FORM

(Base not included)
H : 57 cm
B : 103 cm
W : 80 cm
AS101BT



LADIES BLOUSE FORM

(Base not included)
H : 61 cm
B : 82 cm
W : 63 cm
AS105BT



MENS TORSO FORM

H : 85 cm
B : 103 cm
W : 80 cm
Hi : 97 cm
ASA103

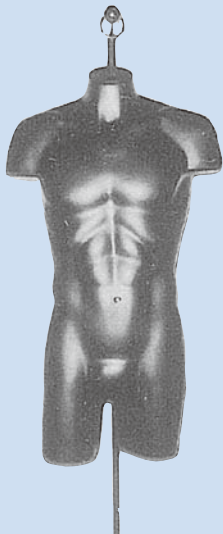

MENS TORSO FORM

With Ring
H : 91 cm
B : 96 cm
W : 76 cm
Hi : 92 cm
A9267-M



LADIES TORSO FORM

With Ring
H : 84 cm
B : 88 cm
W : 66 cm
Hi : 90 cm
A9267MR-F

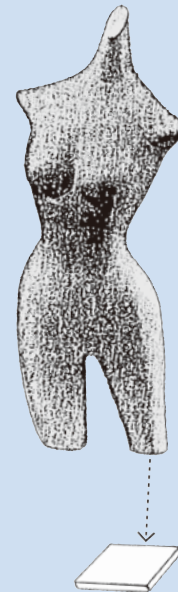

LADIES TORSO FORM

With masonite board
H : 102 cm
B : 80 cm
W : 56 cm
Hi : 82 cm
11FMB



FORM

INJECTION & VACUUM FORM



P76

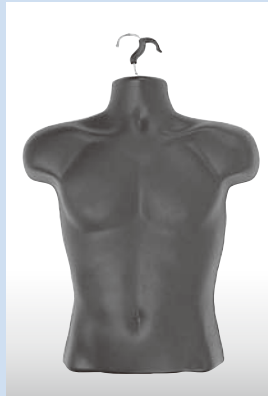

P78



P77



P88



MC-0260

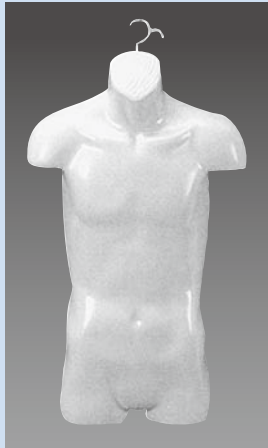

MC-0261

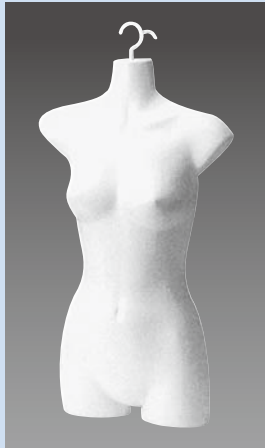

MC-0264

INJECTION FORM

4 Colors are available:
Black, White, Clear Frost
& Fleshtone.

- # P76 Female
- # P78 Male
- # P77 Female
- # P88 Male
- # MC-0260 Female
- # MC-0261 Male
- # MC-0264 Female



P30



P26



P28



P29



P36



P39

VACUUM FORM

- # P30 female, black/white
- # P26 female, black/white
- # P28 female, black/white
- # P29 female, black/white
- # P36 female, clear
- # P39 female, clear



MC-0263



167



135

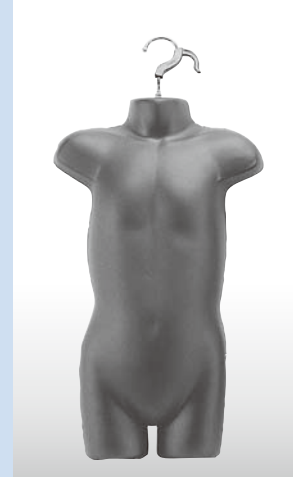

155

INJECTION FORM

4 Colors are available:
Matte Black, White, Clear
Frost & Fleshtone.

- # MC-0263 Female's torso
- # 167 Female's torso
- # 135 Little child
- # 155 Junior child
- # 298 Male's trunk
- # 299 Female's panty
- # 399 Female's butt

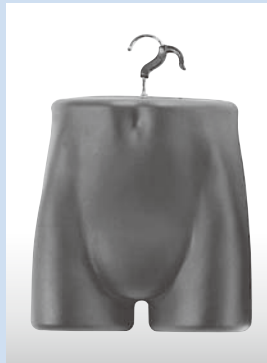

298



299



399

198

199

INJECTION FORM WITH HOOK

3 Colors are available:
Matte Black, White & Clear Frost.

- # 198 Male's shirt
- # 199 Female's blouse

BASE FOR SHIRT AND BLOUSE FORM

- # 660 Metal base, 7-3/4" dia.
With 16"H upright
- # 660A Metal base, 7-3/4" dia.
With 19"H upright
- # 661 Plastic base, 7-3/4" dia.
With 16"H upright
- # 661A Plastic base, 7-3/4" dia.
With 19"H upright



660
660A



661
661A

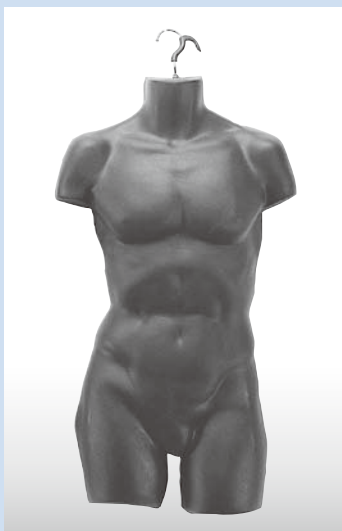

W74

INJECTION FORM

4 Colors are available:
Matte Black, White, Clear Frost & Fleshtone.

- #W74 Male's torso
- #W30 Female's torso
- #W31 Female's torso
- #W78 Female's torso
- #W76 Little child
- #W92 Junior child

3 Colors are available:
Glossy Black, White & Clear Frost.

- #W33 Junior child
- #W34 Female's torso
- #W35 Female's torso



W30

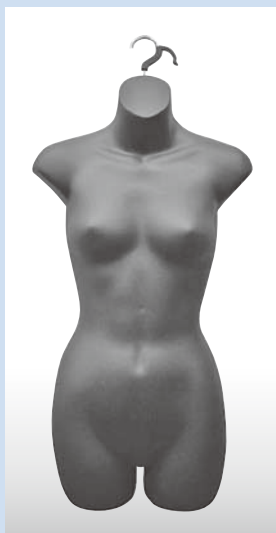

W31



W34



W35



W78



W76

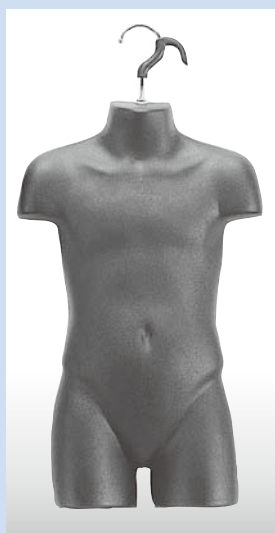

W92

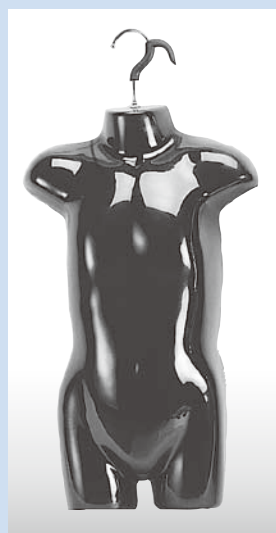

W33

**MEN'S DRESS FORM
 BLACK**

With black wood neck block
 and black wood tripod base.

H : 74 cm
 B : 96 cm
 W : 87 cm
 Hi : 103 cm

GM-006PU8B

**MEN'S DRESS FORM
 CREME**

With natural wood neck block
 and natural wood tripod base.

H : 74 cm
 B : 96 cm
 W : 87 cm
 Hi : 103 cm

GM-006PU8W

**LADIES' DRESS FORM
 BLACK**

With black wood neck block,
 black wood tripod base and
 white strap on waist.

H : 77 cm
 B : 93 cm
 W : 63 cm
 Hi : 94 cm

GM-007PUB8

**LADIES' DRESS FORM
 CREME**

With natural wood neck block,
 natural wood tripod base and
 black strap on waist.

H : 77 cm
 B : 93 cm
 W : 63 cm
 Hi : 94 cm

GM-007PUW8

**LADIES' DRESS FORM
 BLACK**

With black wood neck block,
 black wood tripod base and
 white strap on waist.

H : 81 cm
 B : 87 cm
 W : 61 cm
 Hi : 89 cm

KY-822-8B

**LADIES' DRESS FORM
 CREME**

With natural wood neck block,
 natural wood tripod base and
 black strap on waist.

H : 81 cm
 B : 87 cm
 W : 61 cm
 Hi : 89 cm

KY-822-8W



FORM

TORSO FORM



CHILDREN'S DRESS FORM CREME

With natural wood neck block and natural wood tripod base.

H : 38 cm
B : 57 cm
W : 50 cm
Hi : 56 cm

KY-813-8 (AGE 1-2)



CHILDREN'S DRESS FORM CREME

With natural wood neck block and natural wood tripod base.

H : 42 cm
B : 57 cm
W : 51 cm
Hi : 57 cm

KY-814-8 (AGE 3-4)



CHILDREN'S DRESS FORM CREME

With natural wood neck block and natural wood tripod base.

H : 48 cm
B : 63 cm
W : 57 cm
Hi : 62 cm

KY-815-8 (AGE 5-6)



CHILDREN'S DRESS FORM CREME

With natural wood neck block and natural wood tripod base.

H : 53 cm
B : 71 cm
W : 60 cm
Hi : 70 cm

KY-816-8 (AGE 7-8)



CHILDREN'S DRESS FORM CREME

With natural wood neck block and natural wood tripod base.

H : 57 cm
B : 67 cm
W : 59 cm
Hi : 67 cm

KY-817-8 (AGE 9-10)



CHILDREN'S DRESS FORM CREME

With natural wood neck block and natural wood tripod base.

H : 60 cm
B : 76 cm
W : 67 cm
Hi : 77 cm

KY-818-8 (AGE 11-12)



FEMALE LEGS FORM



LF01
Fleshtone color

- PE full form
- 46-1/2" Height
- 39-3/4" Hip
- Round metal base connected to sole



LF01-W
White color

- PE full form
- 46-1/2" Height
- 39-3/4" Hip
- Round metal base connected to sole



417



517

INJECTION BRA FORM

Clear of a blue tint plastic

417 D SIZE BRA STAND

With round metal base
in marble finish

**# 517 D SIZE HANGING BRA
HOLDER**

With Hook

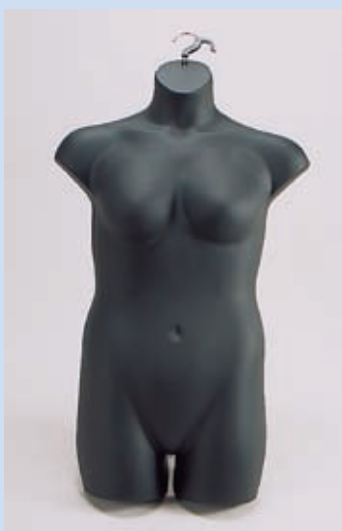

277

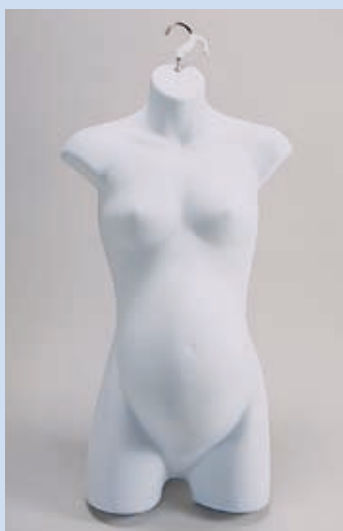

377

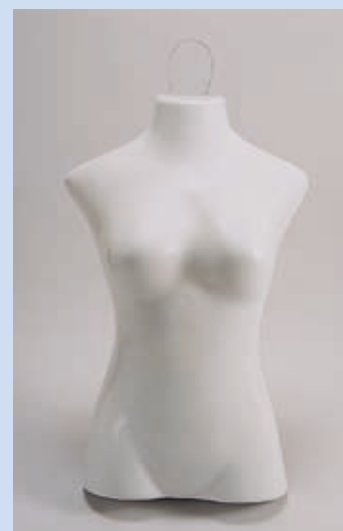

778



556



558

INJECTION FORM

3 Colors are available:

Matte black, white & fleshtone

#277 PLUS SIZE WOMAN

#377 MATERNITY WOMAN

#556 TEENAGE GIRL

#558 TEENAGE BOY

#778 SEXY WOMAN

Glossy milkwhite
with wire hanger



FEMALE FORM

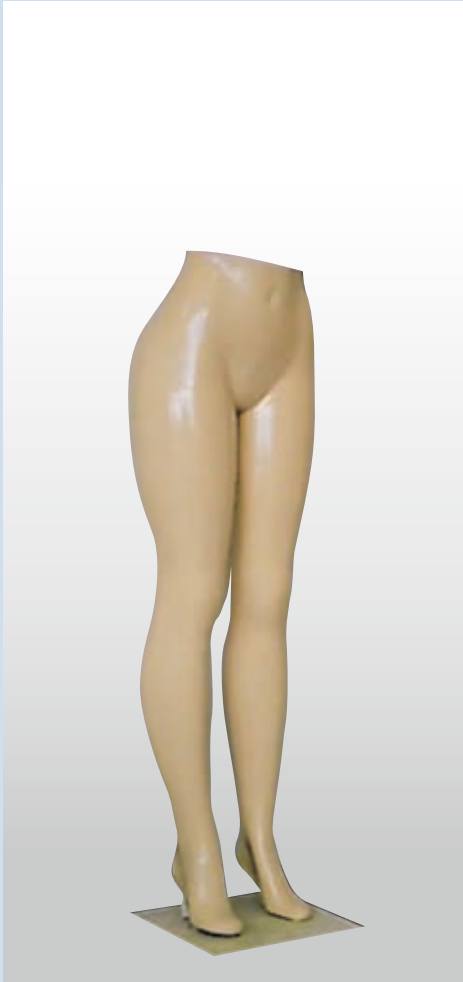

LF02
PLASTIC FEMALE LEGS FORM

- With square metal base
- Fleshtone color
- Height : 47"
- Waist : 25.5"
- Hip : 38.5"

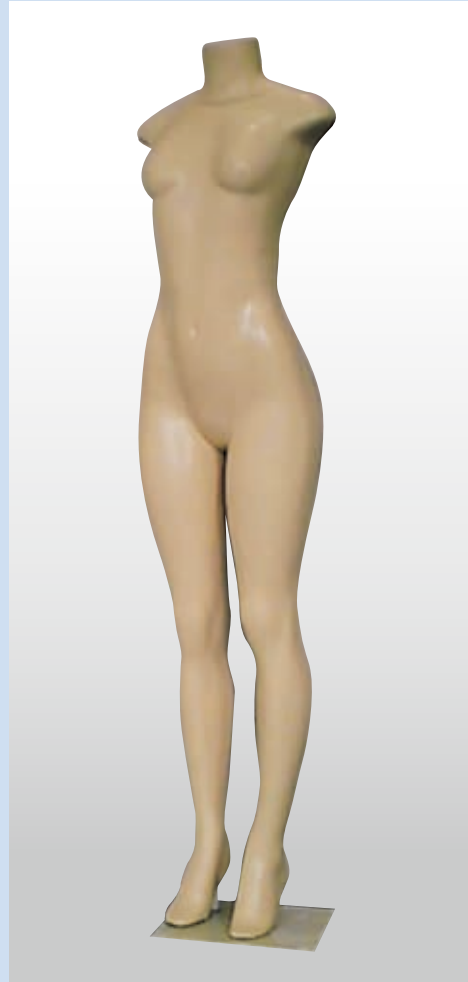

LF03
PLASTIC FEMALE BODY FORM

- With square metal base
- Fleshtone color
- Height : 64"
- Bust : 32.5"
- Waist : 25.5"
- Hip : 38.5"



F12
PLASTIC ROUND BASE

16.75" diameter matching color plastic round base fits #LF02, LF03 & LF05 female form as replacement or optional plastic base.

REMARKS: These items are made in Brazil.

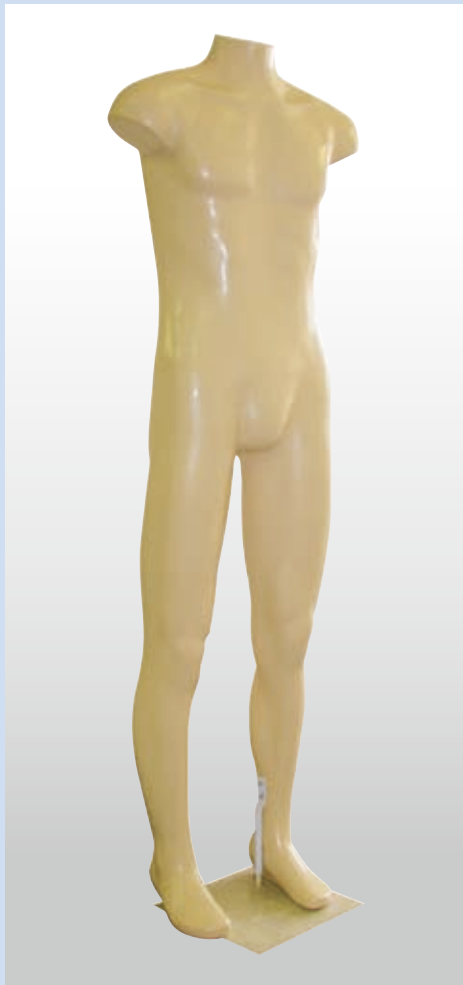

LF04
PLASTIC MALE BODY FORM

- With square metal base
- Fleshtone color
- Height : 68"
- Bust : 39"
- Waist : 32.5"
- Hip : 39"



LF05
PLASTIC LARGER BREAST
FEMALE BODY FORM

- With square metal base
- Fleshtone color
- Height : 64"
- Bust : 34"
- Waist : 26"
- Hip : 40"

REMARKS: These items are made in Brazil.



WOODEN NECK BLOCK

Natural color 9.9 cm dia.

For Item

KY-822-8W &

GM-006PU8W Dress Form

C-12



WOODEN NECK BLOCK

Natural color 9.0 cm dia.

For Item

GM-007PUW8 Dress Form

C-13

WOODEN NECK BLOCK

Black color 9.9 cm dia.

For Item

KY-822-8B &

GM-006PU8B Dress Form

C-12-B



WOODEN NECK BLOCK

Black color 9.0 cm dia.

For Item

GM-007PUB8 Dress Form

C-13-B

WOODEN TRIPOD

Black color

With upright

DYB-8-B



WOODEN TRIPOD

Natural color

With upright

DYB-8-N





DRESSMAKER METAL BASE

- With 7/8" × 42" upright
- Includes spring & casters

L11-1 Chrome
L11-1GB Glossy Black



ADJUSTABLE NOTCHED COSTUMER

- Arm made of 7/8" × 36"L square tubing
- Adjusts from 49" to 78"H every 3"
- Upright made of 1" × 48"L square tubing
- 10" × 14" Weighted steel base

L11-2 Chrome
L11-2SC Satin Chrome
L11-2MB Matte Black
L11-2MW Matte White



MALE HEADLESS MANNEQUIN

- Fine fiberglass construction
- Chromed round metal base, and available with foot & calf rod fittings
- Available with customized colors

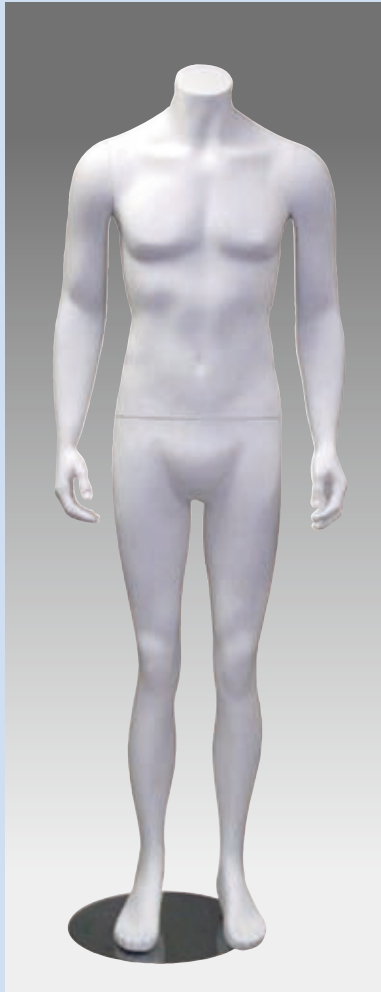

C-1762S-CR1

H : 66"
 S : 20"
 B : 38-1/2"
 W : 31"
 Hi : 38-1/2"
 Color Matte white



CA-M01HL-MW

H : 67"
 S : 22"
 B : 38"
 W : 30"
 Hi : 38-1/2"
 Color Matte white

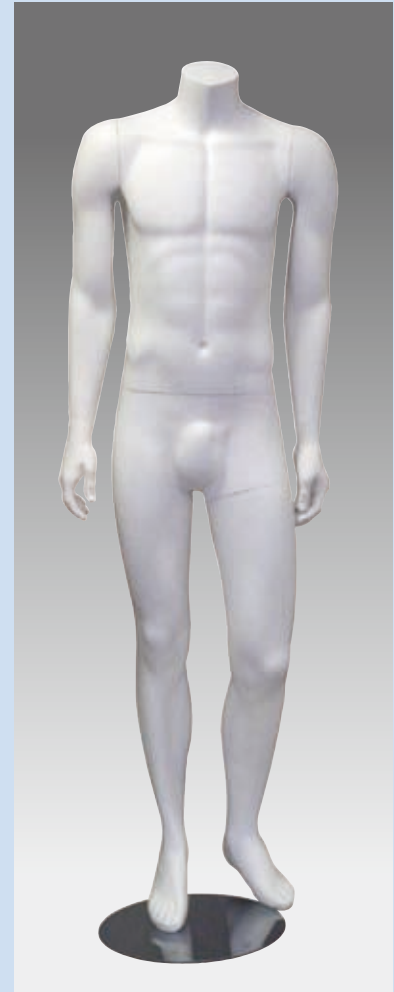

MHL-1MW

H : 67"
 S : 20-1/2"
 B : 36-1/2"
 W : 32"
 Hi : 38"
 Color Matte white



FEMALE HEADLESS MANNEQUIN

- Fine fiberglass construction
- Chromed round metal base, and available with foot & calf rod fittings
- Available with customized colors



FHL-1MW
H : 65-1/2"
S : 16"
B : 34"
W : 26"
Hi : 35-1/2"
Color Matte white

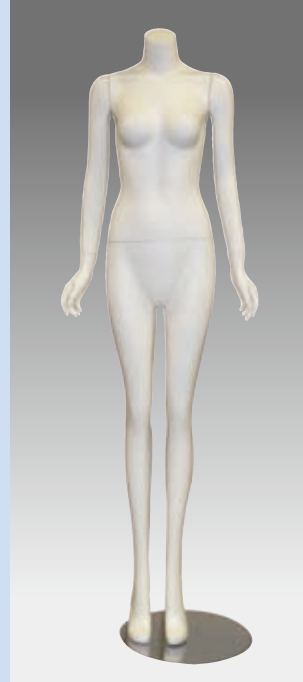

JH11-HL-MW
H : 65"
S : 15"
B : 32"
W : 24"
Hi : 35"
Color Matte white



JH15-HL-MW
H : 65"
S : 14"
B : 33"
W : 23"
Hi : 33-1/2"
Color Matte white

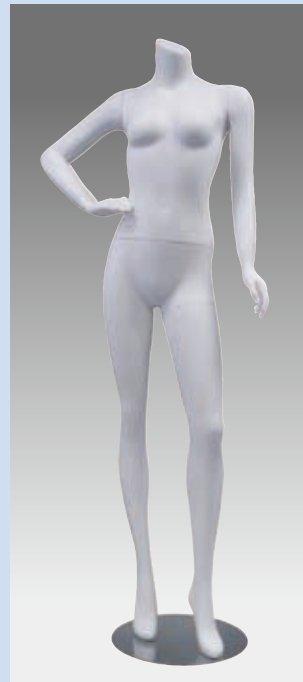

JH21-HL-MW
H : 65"
S : 15-1/2"
B : 32"
W : 23"
Hi : 33-1/2"
Color Matte white



MALE MOLDED HAIR MANNEQUIN



- Fine fiberglass construction
- Chromed round metal base, and available with foot & calf rod fittings
- Available with customized colors

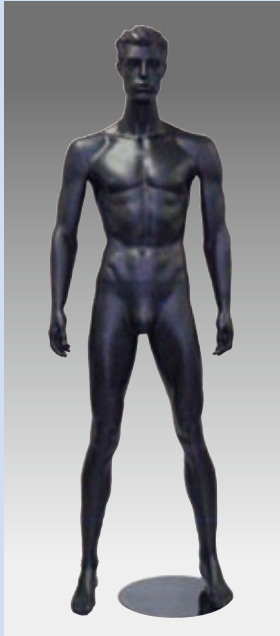

CS-M0906-MB
 H : 74-1/2"
 S : 22-1/2"
 B : 39"
 W : 32"
 Hi : 38"
 Color Matte black



CS-M0906-MF
 H : 74-1/2"
 S : 22-1/2"
 B : 39"
 W : 32"
 Hi : 38"
 Color Matte fleshtone

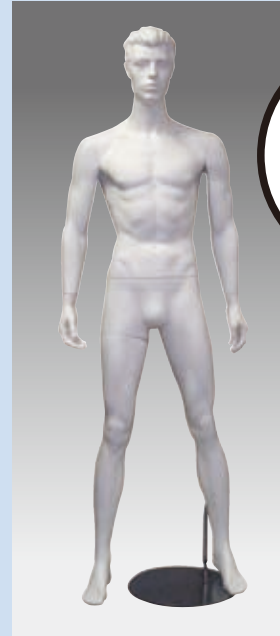

CS-M0906-MW
 H : 74-1/2"
 S : 22-1/2"
 B : 39"
 W : 32"
 Hi : 38"
 Color Matte white

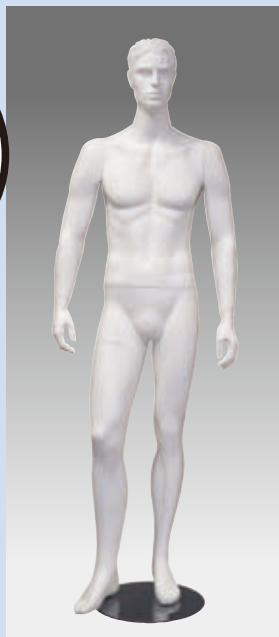

CS-M02-MW
 H : 79"
 S : 20"
 B : 34"
 W : 31-1/2"
 Hi : 38"
 Color Matte white

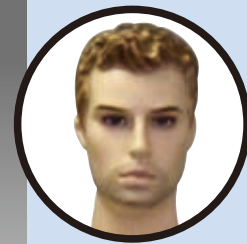

CS-M06M-MF
 H : 75"
 S : 22-1/2"
 B : 39"
 W : 32"
 Hi : 38"
 Color Matte fleshtone



FEMALE MOLDED HAIR MANNEQUIN

- Fine fiberglass construction
- Chromed round metal base, and available with foot & calf rod fittings
- Available with customized colors



CS-F0201-MW

H : 73"

S : 18"

B : 35"

W : 25"

Hi : 36"

Color Matte white



SITTING STYLE MANNEQUIN



- Fine fiberglass construction
- With stool
- Available with customized colors

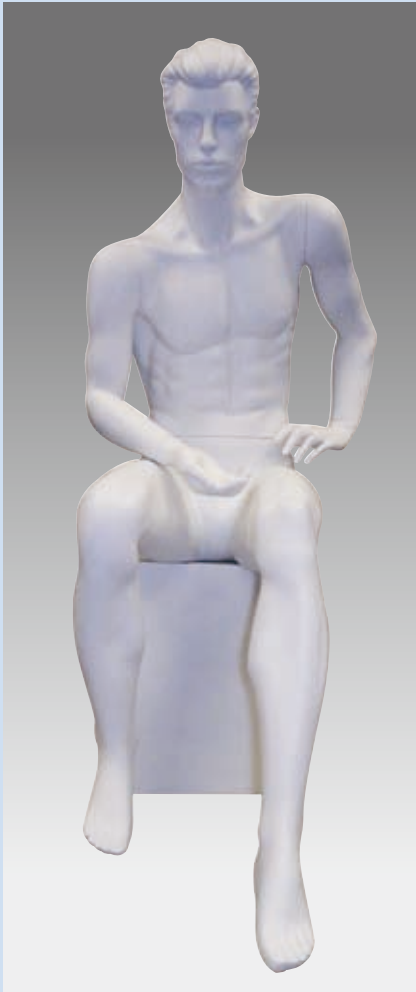

CS-M09-MW

H : 54"
S : 22-1/2"
B : 37"
W : 29-1/2"
Hi : 37-1/2"
Color Matte white

JH-13F11-MW

H : 52-1/2"
S : 15-1/2"
B : 32"
W : 24"
Hi : 33-1/2"
Color Matte white



HIGH GLOSSY MANNEQUINS - ABSTRACT



- Fine fiberglass construction
- Chromed round metal base, and available with foot & calf rod fittings
- High resistant with extra lacquer coated. Color can be customized.

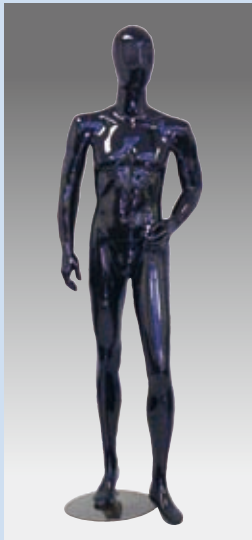

GLEN5-LGB3C

H : 74"
 S : 19-1/2"
 B : 38"
 W : 30"
 Hi : 38-1/2"
 Color Glossy black

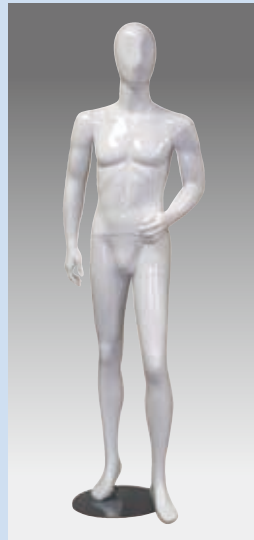

GLEN5-LGW

H : 74"
 S : 19-1/2"
 B : 38"
 W : 30"
 Hi : 38-1/2"
 Color Glossy white

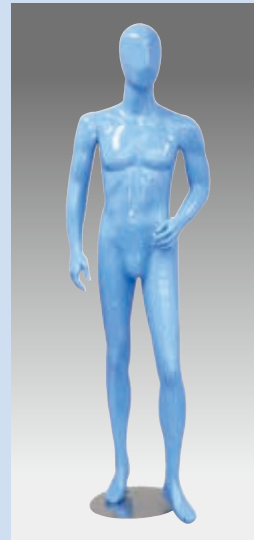

GLEN5-L2925C

H : 74"
 S : 19-1/2"
 B : 38"
 W : 30"
 Hi : 38-1/2"
 Color Glossy sky blue



GLEN5-L1925C

H : 74"
 S : 19-1/2"
 B : 38"
 W : 30"
 Hi : 38-1/2"
 Color Glossy peach red

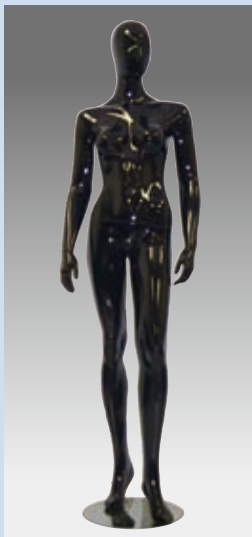

GLEN2-LGB3C

H : 72"
 S : 17-1/2"
 B : 33"
 W : 25"
 Hi : 36"
 Color Glossy black

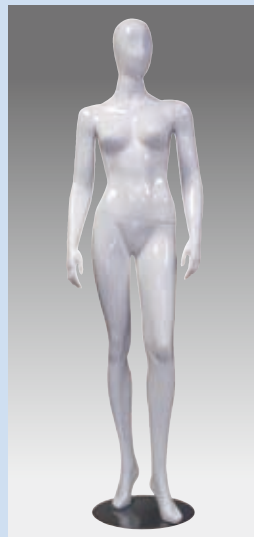

GLEN2-LGW

H : 72"
 S : 17-1/2"
 B : 33"
 W : 25"
 Hi : 36"
 Color Glossy white

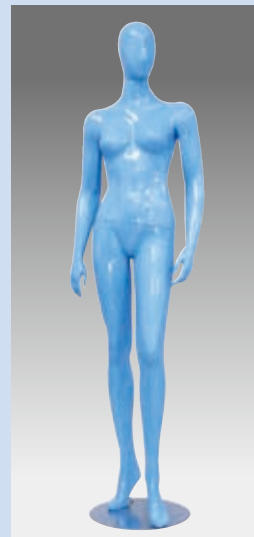

GLEN2-L2925C

H : 72"
 S : 17-1/2"
 B : 33"
 W : 25"
 Hi : 36"
 Color Glossy sky blue

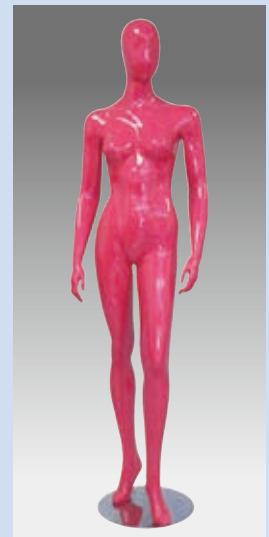

GLEN2-L1925C

H : 72"
 S : 17-1/2"
 B : 33"
 W : 25"
 Hi : 36"
 Color Glossy peach red



HIGH GLOSSY MANNEQUINS - ABSTRACT

- Fine fiberglass construction
- Chromed round metal base, and available with foot & calf rod fittings
- High resistant with extra lacquer coated. Color can be customized.

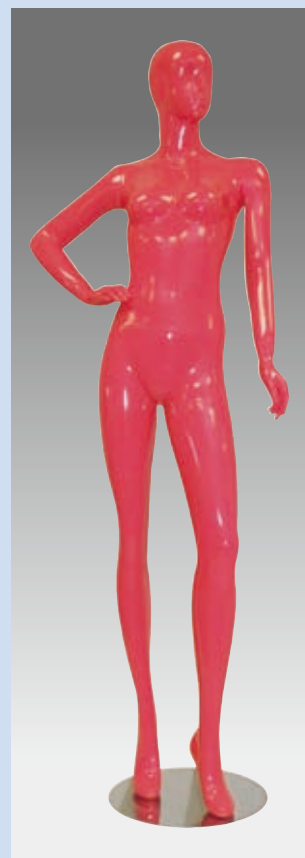
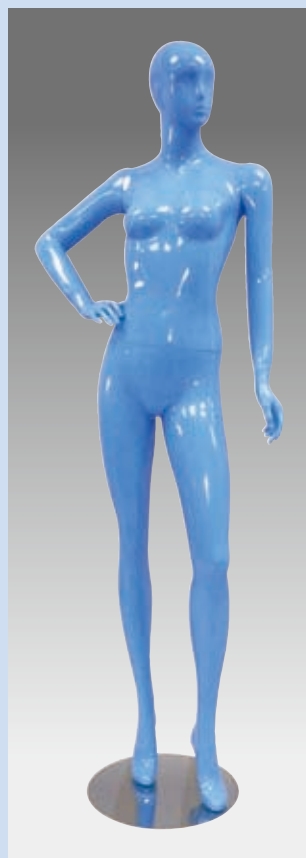
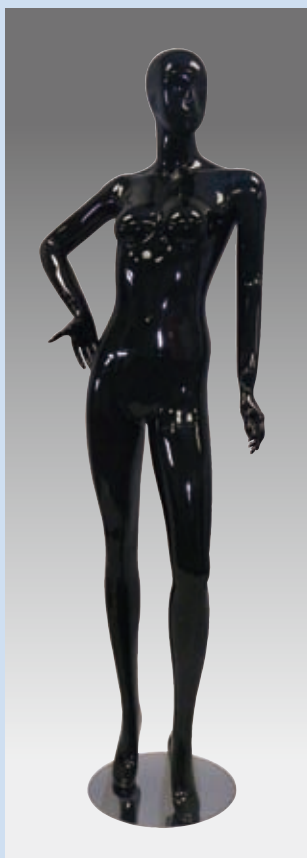

JH21-LGB3C

H : 71"
S : 15-1/2"
B : 32"
W : 23"
Hi : 33-1/2"
Color Glossy black

JH21-LGW

H : 71"
S : 15-1/2"
B : 32"
W : 23"
Hi : 33-1/2"
Color Glossy white

JH21-L2925C

H : 71"
S : 15-1/2"
B : 32"
W : 23"
Hi : 33-1/2"
Color Glossy sky blue

JH21-L1925C

H : 71"
S : 15-1/2"
B : 32"
W : 23"
Hi : 33-1/2"
Color Glossy peach red

KIDS MANNEQUIN - MOLDED HAIR

- Fine fiberglass construction
- Chromed round metal base, and available with foot & calf rod fittings
- Available with customized colors

C-MH01-MF

H : 35-1/2"
 S : 12"
 B : 20-1/2"
 W : 20"
 Hi : 23"
 Color Matte fleshtone

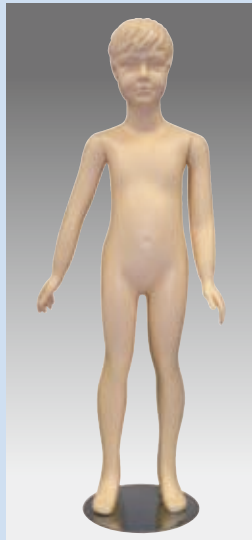
C-MH02-MF

H : 45"
 S : 14"
 B : 24"
 W : 22"
 Hi : 27-1/2"
 Color Matte fleshtone

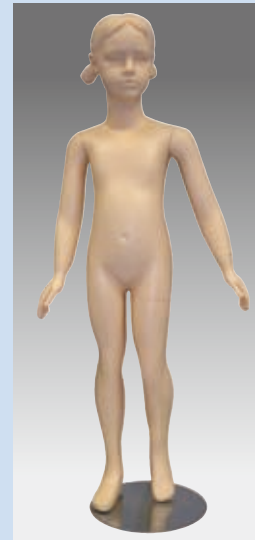
C-MH03-MF

H : 45"
 S : 14"
 B : 24"
 W : 22"
 Hi : 27"
 Color Matte fleshtone

C-MH04-MF

H : 56-1/2"
 S : 16"
 B : 29-1/2"
 W : 24-1/2"
 Hi : 31"
 Color Matte fleshtone

C-MH05-MF

H : 56-1/2"
 S : 16"
 B : 29-1/2"
 W : 24-1/2"
 Hi : 31"
 Color Matte fleshtone

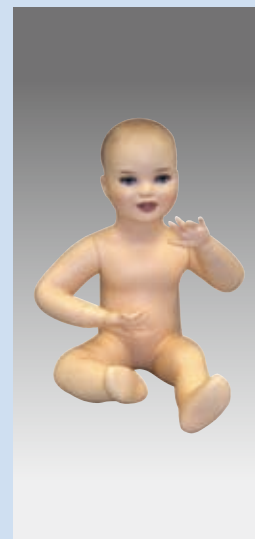
BABY1-MF

H : 18"
 S : 8-1/2"
 B : 18-1/2"
 W : 20"
 Color Matte fleshtone



KIDS MANNEQUIN - HEADLESS

- Fine fiberglass construction
- Chromed round metal base, and available with foot & calf rod fittings
- Available with customized colors



C-MH01HL-MF
H : 29-1/2"
S : 12"
B : 20-1/2"
W : 20"
Hi : 23"
Color Matte fleshtone



C-MH02HL-MF
H : 39"
S : 14"
B : 24"
W : 22"
Hi : 27-1/2"
Color Matte fleshtone



C-MH03HL-MF
H : 39"
S : 14"
B : 24"
W : 22"
Hi : 27-1/2"
Color Matte fleshtone



C-MH05HL-MF
H : 50-1/2"
S : 16"
B : 29-1/2"
W : 24-1/2"
Hi : 31"
Color Matte fleshtone

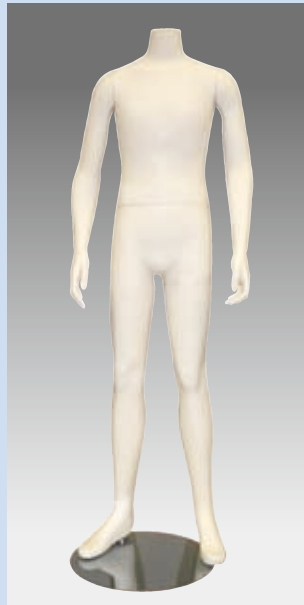

HK051-HL-MW
H : 50"
S : 15-1/2"
B : 27"
W : 23"
Hi : 28-1/2"
Color Matte white



HEADLESS 3/4 TORSO MANNEQUIN



- Fine fiberglass construction
- Chromed round metal base with post
- Available with customized colors

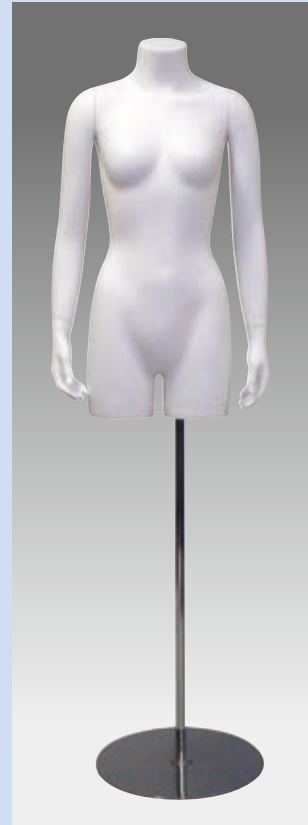
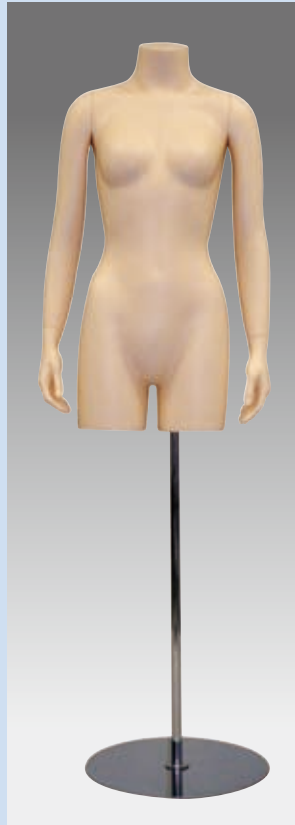
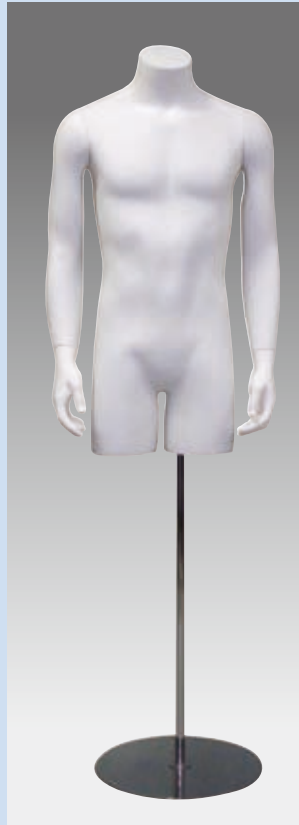

MTF-1MF

H : 35"
S : 18"
B : 37"
W : 29-1/2"
Hi : 38"
Color Matte fleshtone

MTF-1MW

H : 35"
S : 18"
B : 37"
W : 29-1/2"
Hi : 38"
Color Matte white

FTF-1MF

H : 32"
S : 15"
B : 33"
W : 24"
Hi : 35"
Color Matte fleshtone

FTF-1MW

H : 32"
S : 15"
B : 33"
W : 24"
Hi : 35"
Color Matte white



LOWER BODY MANNEQUIN

- Fine fiberglass construction
- Chromed round metal base, and available with foot & calf rod fittings
- Available with customized colors



KD1-MW
Male lower body
H : 46"
W : 30"
Hi : 38"
Color Matte white



KD6-MW
Female lower body
H : 47-1/2"
W : 27-1/2"
Hi : 36-1/2"
Color Matte white



HEADLESS KIDS SOFT FORM

- PU foam and pose adjustable
- Creme color with chrome base
- Wooden flat neck block



CY-4E695C
 H : 21"
 S : 8-1/2"
 B : 18"
 W : 17-1/2"
 Hi : 18"
 Type 6 Month



CY-4E696C
 H : 31"
 S : 10"
 B : 19"
 W : 18"
 Hi : 19-1/2"
 Type 3 Years Old

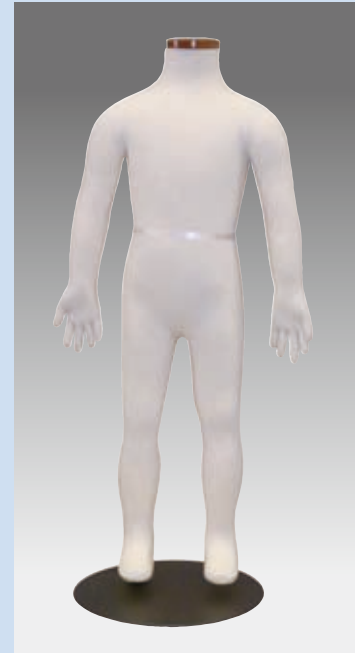

CY-4E699C
 H : 34-1/2"
 S : 10"
 B : 20-1/2"
 W : 19"
 Hi : 25"
 Type 5 Years Old

M

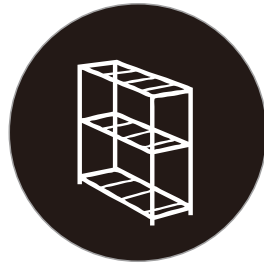

WIRE SHELVING SYSTEM

CHAPTER	DIVISION	CONTENTS
M	01	OMNI SHELVING SYSTEM

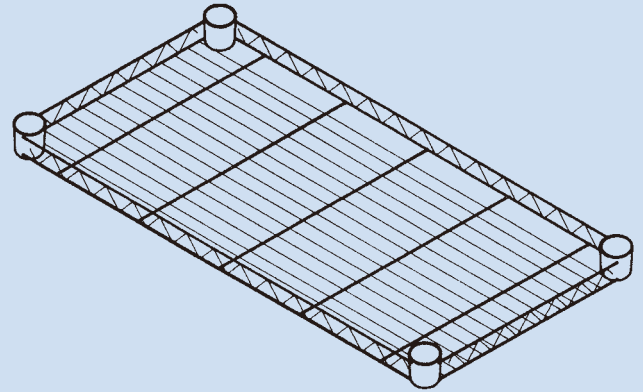
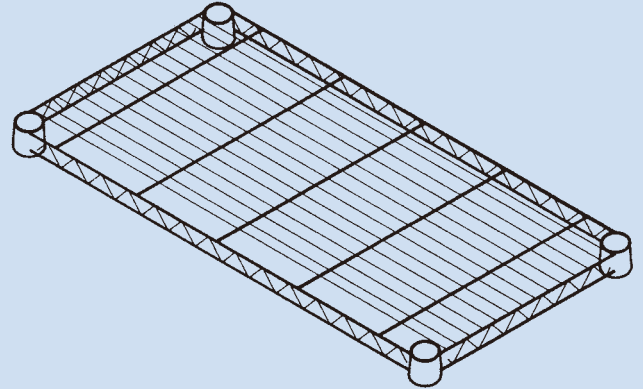

MEDIUM WEIGHT WIRE SHELVES

Size (INCH)	ITEM NO. Chrome Plated	ITEM NO. Black Epoxy	ITEM NO. White Epoxy
14 × 24	M1424C	M1424B	M1424W
14 × 30	M1430C	M1430B	M1430W
14 × 36	M1436C	M1436B	M1436W
14 × 48	M1448C	M1448B	M1448W
14 × 60	M1460C	M1460B	M1460W
14 × 72	M1472C	M1472B	M1472W
18 × 24	M1824C	M1824B	M1824W
18 × 30	M1830C	M1830B	M1830W
18 × 36	M1836C	M1836B	M1836W
18 × 48	M1848C	M1848B	M1848W
18 × 60	M1860C	M1860B	M1860W
18 × 72	M1872C	M1872B	M1872W
24 × 24	M2424C	M2424B	M2424W
24 × 30	M2430C	M2430B	M2430W
24 × 36	M2436C	M2436B	M2436W
24 × 48	M2448C	M2448B	M2448W
24 × 60	M2460C	M2460B	M2460W
24 × 72	M2472C	M2472B	M2472W



**NSF
APPROVED!**

OMNI SHELVING SYSTEM SHELF

MAY / 2011

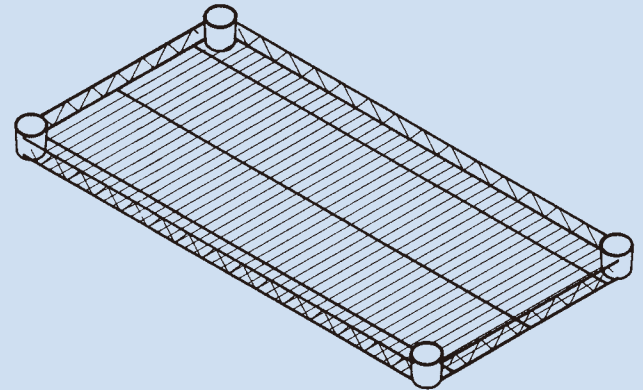
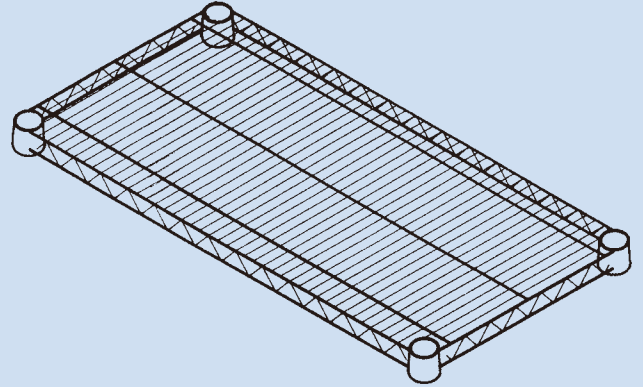

HEAVY WEIGHT WIRE SHELVES

Size (INCH)	ITEM NO. Chrome Plated	ITEM NO. Black Epoxy	ITEM NO. White Epoxy
14 × 24	H1424C	H1424B	H1424W
14 × 30	H1430C	H1430B	H1430W
14 × 36	H1436C	H1436B	H1436W
14 × 48	H1448C	H1448B	H1448W
14 × 60	H1460C	H1460B	H1460W
14 × 72	H1472C	H1472B	H1472W
18 × 24	H1824C	H1824B	H1824W
18 × 30	H1830C	H1830B	H1830W
18 × 36	H1836C	H1836B	H1836W
18 × 48	H1848C	H1848B	H1848W
18 × 60	H1860C	H1860B	H1860W
18 × 72	H1872C	H1872B	H1872W
24 × 24	H2424C	H2424B	H2424W
24 × 30	H2430C	H2430B	H2430W
24 × 36	H2436C	H2436B	H2436W
24 × 48	H2448C	H2448B	H2448W
24 × 60	H2460C	H2460B	H2460W
24 × 72	H2472C	H2472B	H2472W

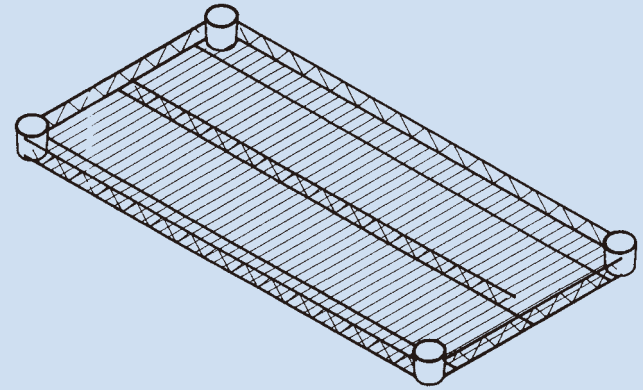
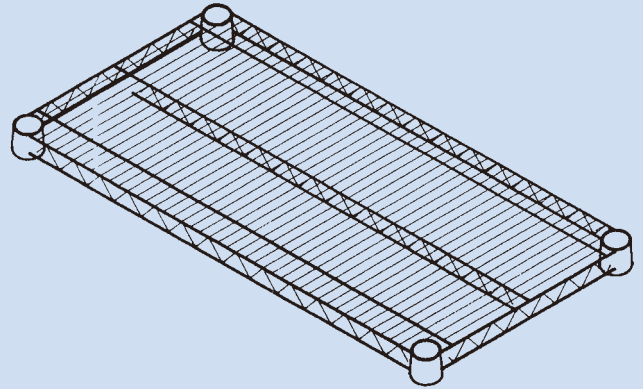
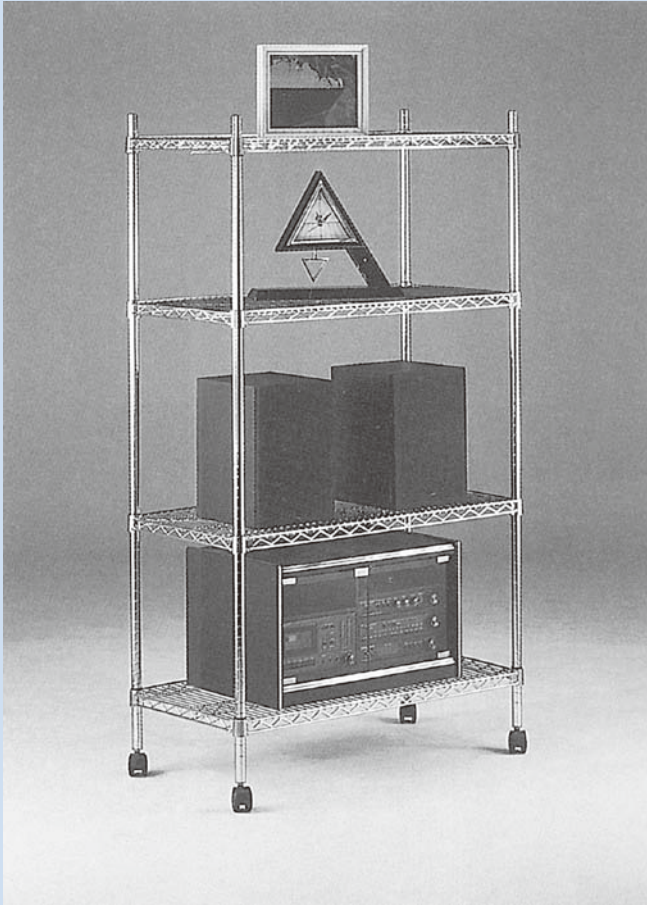

EXTRA HEAVY DUTY WIRE SHELVES

Size (INCH)	ITEM NO. Chrome Plated	ITEM NO. Black Epoxy	ITEM NO. White Epoxy
14 × 24	EX1424C	EX1424B	EX1424W
14 × 30	EX1430C	EX1430B	EX1430W
14 × 36	EX1436C	EX1436B	EX1436W
14 × 48	EX1448C	EX1448B	EX1448W
14 × 60	EX1460C	EX1460B	EX1460W
14 × 72	EX1472C	EX1472B	EX1472W
18 × 24	EX1824C	EX1824B	EX1824W
18 × 30	EX1830C	EX1830B	EX1830W
18 × 36	EX1836C	EX1836B	EX1836W
18 × 48	EX1848C	EX1848B	EX1848W
18 × 60	EX1860C	EX1860B	EX1860W
18 × 72	EX1872C	EX1872B	EX1872W
24 × 24	EX2424C	EX2424B	EX2424W
24 × 30	EX2430C	EX2430B	EX2430W
24 × 36	EX2436C	EX2436B	EX2436W
24 × 48	EX2448C	EX2448B	EX2448W
24 × 60	EX2460C	EX2460B	EX2460W
24 × 72	EX2472C	EX2472B	EX2472W



OMNI SHELVING SYSTEM

POST

POST FOR SHELVES

ONE SECTION CONSTRUCTION

TWO SECTION CONSTRUCTION



Size (INCH)	ITEM NO. Chrome Plated		ITEM NO. Black Epoxy		ITEM NO. White Epoxy	
	1-SECTION	2-SECTION	1-SECTION	2-SECTION	1-SECTION	2-SECTION
14	P14C	P14C-2	P14B	P14B-2	P14W	P14W-2
34	P34C	P34C-2	P34B	P34B-2	P34W	P34W-2
54	P54C	P54C-2	P54B	P54B-2	P54W	P54W-2
63	P63C	P63C-2	P63B	P63B-2	P63W	P63W-2
72	P72C	P72C-2	P72B	P72B-2	P72W	P72W-2
74	P74C	P74C-2	P74B	P74B-2	P74W	P74W-2
86	P86C	P86C-2	P86B	P86B-2	P86W	P86W-2

ASSEMBLY INSTRUCTION

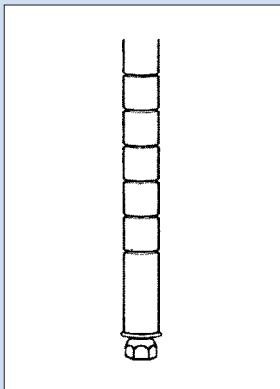

The grooves of posts are at 1" intervals along their entire height.

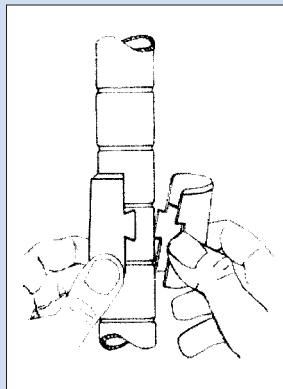

Snap-on the split sleeves at the desired position.

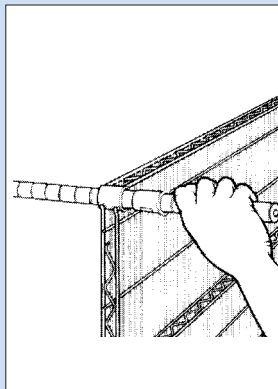

Tapered openings in the shelf corner slide over the tapered split sleeves, becomes more secure as shelf load increases.

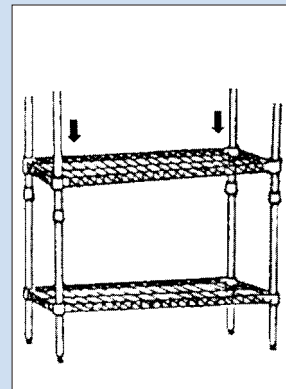

Tap shelves down in corners, making shelves seat properly.

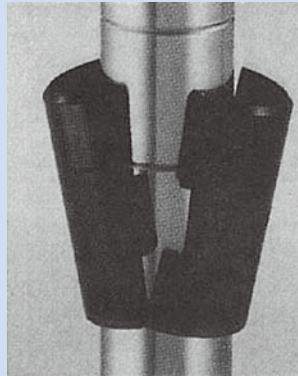
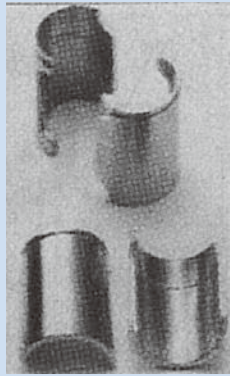

SPLIT SLEEVES

Material: ABS

OM01

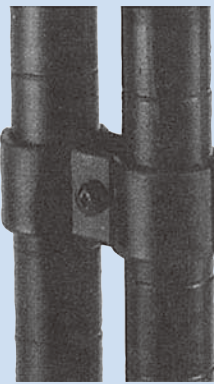
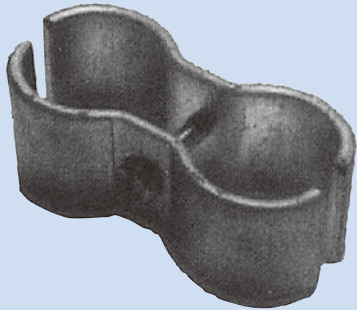

POST CLAMP

Provide maximum strength in shelving units by clamping together adjacent posts.

OM02

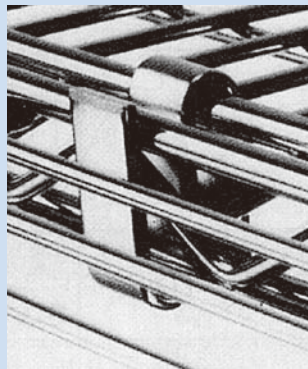

"S" HOOK

To be used to "add on" shelving units, saving the cost of two posts.

OM03

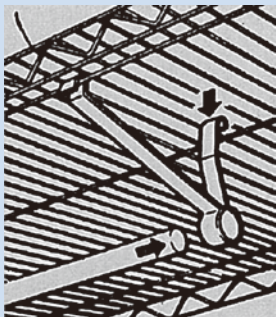

GARMENT HANGER TUBE WITH 2-PC V BRACKETS

Tube sizes:
30", 36", 48", 60".

OM04



OMNI SHELVING SYSTEM

ACCESSORIES

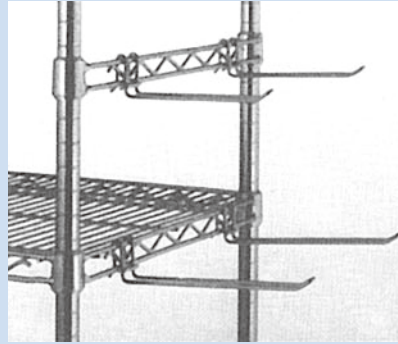

DISPLAY HOOKS

Snap on shelf hanger rails and shelf frames. Available length: 6" And 8"

OM05

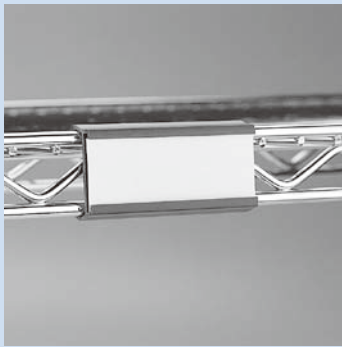

PLASTIC LABEL HOLDER

Molded plastic label holders snap over shelf edge, to hold 3" x 1" label.

OM06



TRIANGLE PROTECTING PLATE

Fit over leveling foot to protect tile floors.

OM07



SHELF CONNECTOR

Used for added security to "add on" shelving units. Includes "S" hook, nut and bolt.

OM08



BUILT-IN LEVELLER

Black lid fit for uneven surface.

OM09



CONVERTIBLE LEVELLER

Gray lid, fit for uneven surface.

OM09-N

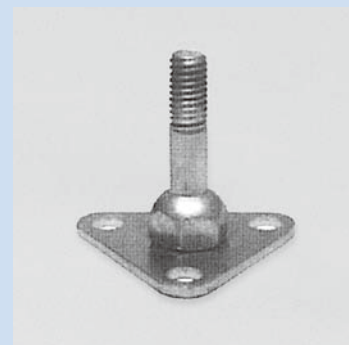

FOOT PLATE

To replace the leveling foot when units are to be bolted to the floor or when a broader foot is needed.

OM10

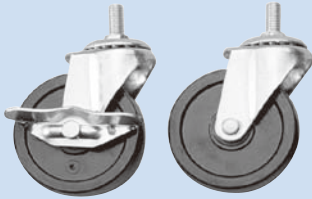

BLACK PVC CASTERS

2 Locking & 2 Non-Locking

SPVC3 3" DIA

SPVC5 5" DIA

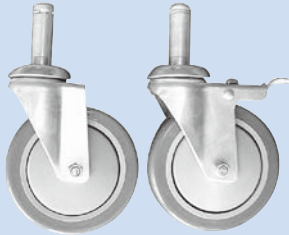

5" DIA PU CASTERS STEM TYPE

PU5-B Black Color Non-Locking

PU5-B-L Black Color Locking

PU5-G Gray Color Non-Locking

PU5-G-L Gray Color Locking

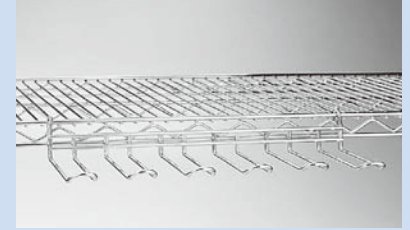

TOOL HOLDER

Attaches to shelf, hanger rail or mounting rail to hold tools, long handle tool, cords, wire, etc.

OM15



RODS AND TABS

Can be used in place of shelf ledges and dividers to form vertical barriers throughout wire shelving units. (One tab per shelf per rod)

OM12



SNAP-ON HOOKS (SMALL)

Attach to kits, hanger rails or shelf frame.

OM16

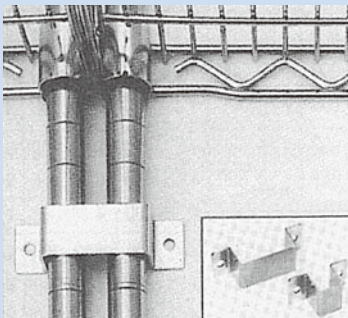

WALL MOUNT CLAMP

For one post.
For two post.

OM13

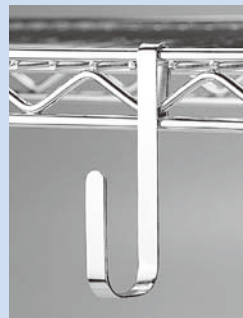

SNAP-ON HOOKS (LARGE)

Attach to kits, hanger rails or shelf frame.

OM17



SHELF DIVIDERS

To keep shelf contents orderly by Compartmentalizing shelves. They can be repositioned easily.

Available size:
14", 18", 24", 30", 36"

OM14

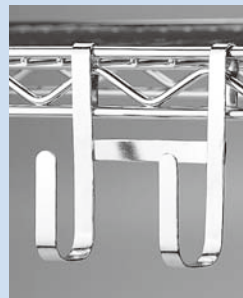

SNAP-ON DOUBLE UTILITY HOOK

Attach to kits, hanger rails or shelf frame.

OM18



OMNI SHELVING SYSTEM

ACCESSORIES



Small Display Basket
7"H × 13³/₈"W × 5"D

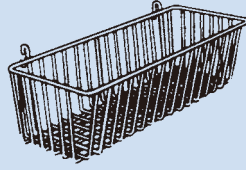

Medium Display Basket
5"H × 17³/₈"W × 7¹/₂"D

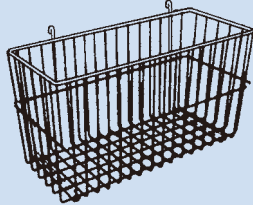

Large Display Basket
10"H × 17³/₈"W × 7¹/₂"D

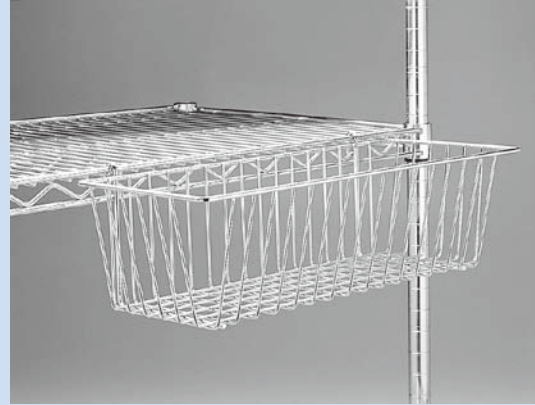

WIRE BASKETS

Attach to shelves or hang rails.

OM19

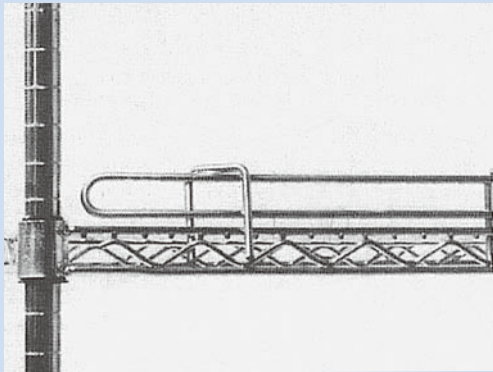

1" SIDE & BACK LEDGE

Attach to wire shelf to prevent items from falling off, while still permitting access to the shelf.

Available length:
14", 18", 24", 30", 36", 42", 48", 54", 60"

OM20

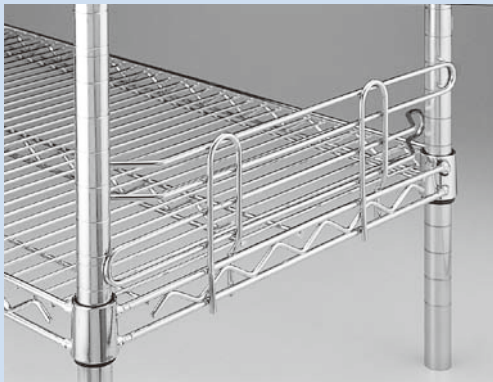

4" SIDE & BACK LEDGES

When a higher ledge is needed, 4" side and back ledges can be installed. These ledges can be stacked to form an 8" or higher barrier.

Available length:
14", 18", 24", 30", 36", 48", 60"

OM21

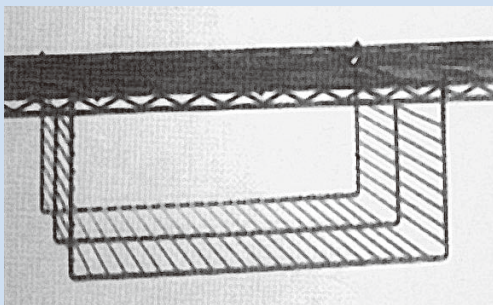

UNDERSHELF BASKET

Attach to undershelf to hold a variety of merchandise 18" deep.

OM22

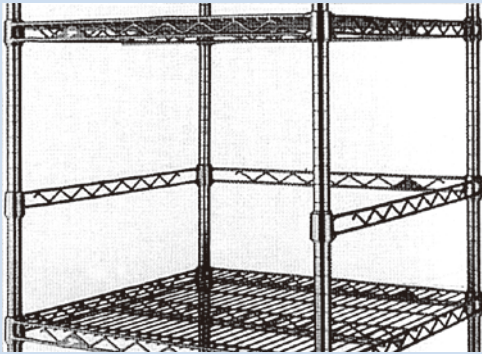

RETAINS FRAME

Retains larger items from falling off shelf.
Available side to fit shelf:
24" x 24", 24" x 48".

OM23

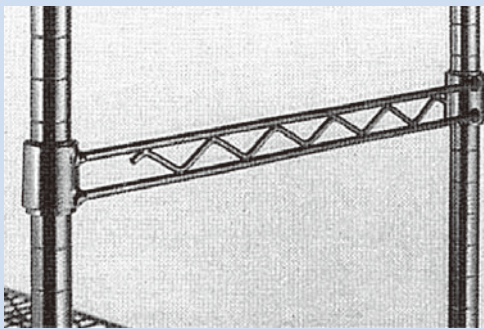

HANGER RAILS

Fit on posts to run width or length of unit.
Accepts display hooks, display baskets,
"S" hooked shelving, etc.
Available length:
14", 18", 24", 30", 36", 48".

OM24

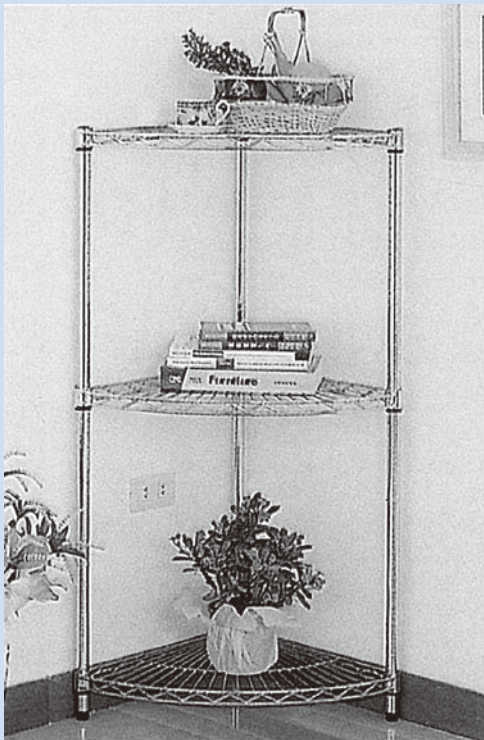

SPACIOUS UNIT

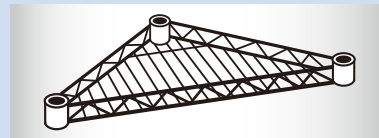

TRIANGLE SHELVING

Available Width: 14", 18", 24"

OM25

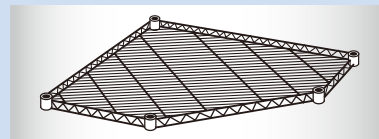

PENTAGON SHELVING

Available size: L27" x W18"

OM25P

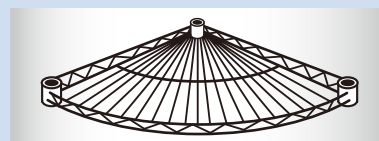

SECTOR SHELVING

Available width: 14", 18", 24"

OM25S



OMNI SHELVING SYSTEM

ACCESSORIES

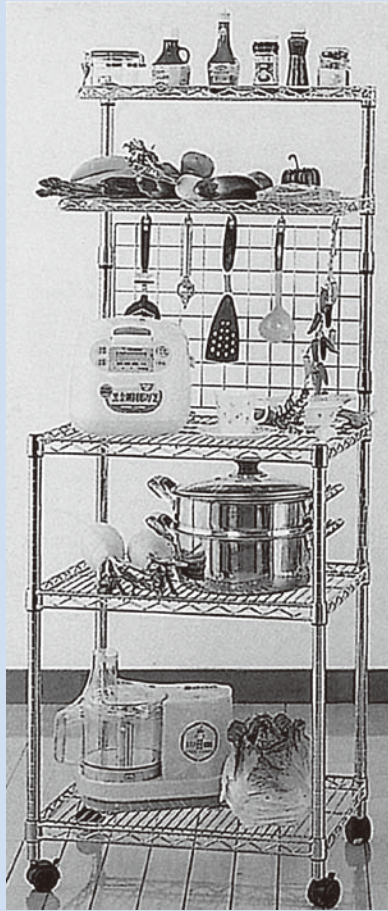

MODERN KITCHEN UNIT

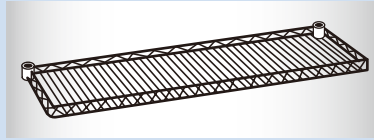

HEAVY TYPE CANTILEVER SHELF

Available size:

- L24" × W6"
- L24" × W8"
- L24" × W12"
- L36" × W12"
- L48" × W12"

OM26H

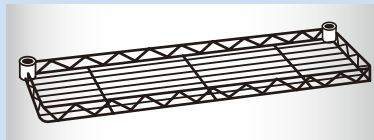

LIGHT TYPE CANTILEVER SHELF

Available size:

- L18" × W6"
- L36" × W12"

OM26L

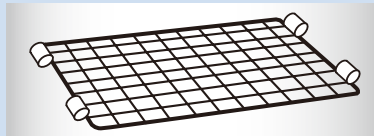

BACK LEDGE

Available size:

- L24" × W14"
- L36" × W14"
- L48" × W16"

OM27

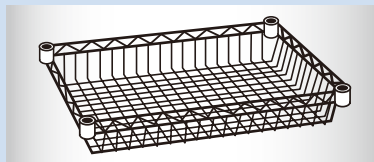

NEST BASKET

Available size:

- L24" × W18"

OM28

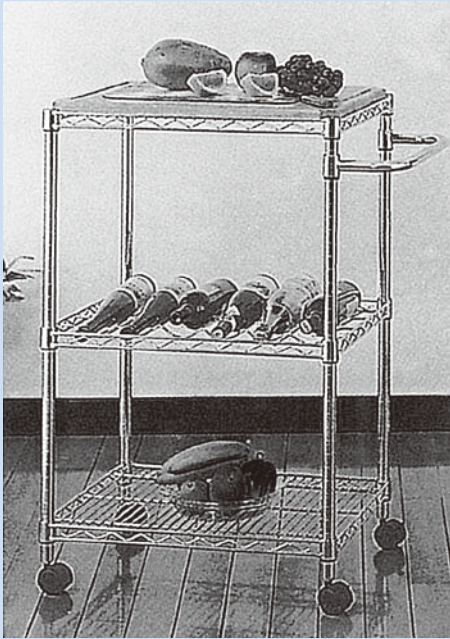

UTILITY CARTS UNIT

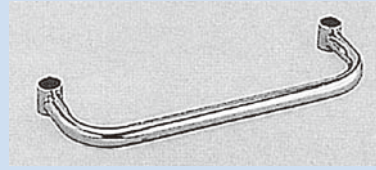

EXTENDED HANDLE

Available size: 18", 24"

OM29

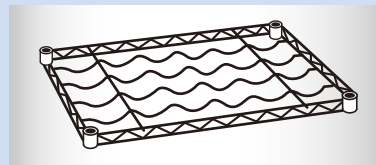

WINE SHELVING

Available size:

L24" x W14"

L36" x W18"

OM30

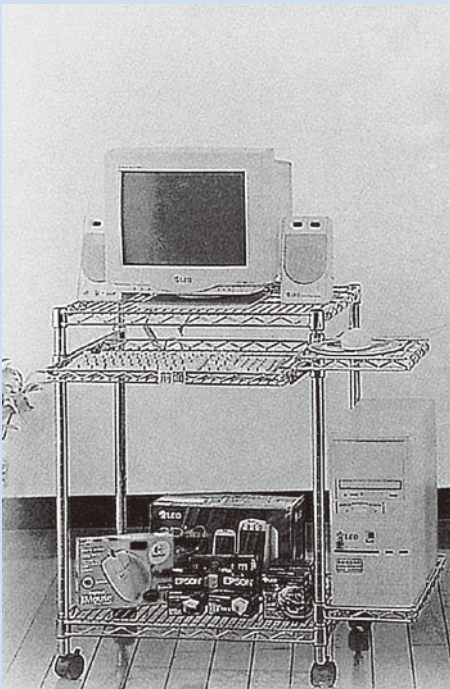

PRACTICAL COMPUTER CARTS UNIT

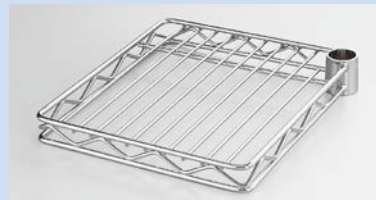

MOUSE SHELVING

Available size: 9" x 10"

OM31

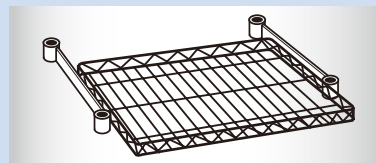

PULL-OUT SHELVING

Available size:

L24" x W18"

L30" x W18"

L36" x W18"

OM32



OMNI SHELVING SYSTEM

MODULAR UNIT

MAY / 2011

- Commercial / Industrial grade steel
- Medium duty wire shelving, black
- NSF approved
- Shelves adjust on 1" increments
- Leveling feet adjust to accommodate for uneven floor
- Two section construction of posts for easy package & storage



MEDIUM DUTY 4 WIRE SHELVING 18"D × 36"W × 72"H, BLACK

CONSIST OF :

Q'TY	CAT. NO.	
4	M1836B	SHELVES
4	P72B-2	POSTS

M1836-4-72B



- Commercial / Industrial grade steel
- Heavy duty wire shelving, chromed
- NSF approved
- Shelves adjust on 1" increments
- Leveling feet adjust to accommodate for uneven floor
- Two section construction of posts for easy package & storage
- 3" Dia. PVC casters, 2 locking & 2 non-locking



HEAVY DUTY 5 WIRE SHELVING UNIT 18"D × 36"W × 72"H, CHROMED

CONSIST OF :

Q'TY	CAT. NO.	
5	H1836C	SHELVES
4	P72C-2	POSTS
4	SPVC3	CASTERS

H1836-5-72C



OMNI SHELVING SYSTEM

MODULAR UNIT

- Commercial / Industrial grade steel
- Heavy duty wire shelving, chromed
- NSF approved
- Shelves adjust on 1" increments
- Leveling feet adjust to accommodate for uneven floor
- Two section construction of posts for easy package & storage
- 3"Dia. PVC casters, 2 locking & 2 non-locking



HEAVY DUTY 4 WIRE SHELVING UNIT 18"D × 48"W × 72"H, CHROMED

CONSIST OF :

Q'TY	CAT. NO.	
4	H1848C	SHELVES
4	P72C-2	POSTS
4	SPVC3	CASTERS

H1848-4-72C



- Commercial / Industrial grade steel
- Heavy duty wire shelving, chromed
- NSF approved
- Shelves adjust on 1" increments
- Leveling feet adjust to accommodate for uneven floor
- Two section construction of posts for easy package & storage
- 3"Dia. PVC casters, 2 locking & 2 non-locking



HEAVY DUTY 5 WIRE SHELVING UNIT 18"D × 48"W × 72"H, CHROMED

CONSIST OF :

Q'TY	CAT. NO.	
5	H1848C	SHELVES
4	P72C-2	POSTS
4	SPVC3	CASTERS

H1848-5-72C



OMNI SHELVING SYSTEM

MODULAR UNIT

MAY / 2011

- Commercial / Industrial grade steel
- Extra Heavy eavy duty wire shelving, chromed
- NSF approved
- Shelves adjust on 1" increments
- Leveling feet adjust to accommodate for uneven floor
- Two section construction of posts for easy package & storage
- 3"Dia. PVC casters, 2 locking & 2 non-locking



P72C-2 POST



SPVC3 CASTER

EXTRA HEAVY DUTY 5 WIRE SHELVING UNIT 18"D × 48"W × 72"H, CHROMED

CONSIST OF :

Q'TY	CAT. NO.	
5	EX1848C	SHELVES
4	P72C-2	POSTS
4	SPVC3	CASTERS

EX1848-5-72C

**UTILITY CART UNIT 18"D x 36"W x 33"H, CHROMED**

CONSIST OF :

- 2 PCS. HEAVY DUTY WIRE SHELVES 18"D x 36"W
- 2 PCS. 3 SECTION U SHAPE HANDLE POSTS 18"D x 33"H
- 4 PCS. DONUT BUMPERS BLACK
- 4 PCS. 5"DIA PVC CASTERS, 2 LOCKING & 2 NON-LOCKING

UC1836C

UTILITY CART UNIT 24"D x 48"W x 33"H, CHROMED

- 2 PCS. HEAVY DUTY WIRE SHELVES 24"D x 48"W
- 2 PCS. 3 SECTION U SHAPE HANDLE POSTS 24"D x 33"H
- 4 PCS. DONUT BUMPERS BLACK
- 4 PCS. 5"DIA PVC CASTERS, 2 LOCKING & 2 NON-LOCKING

UC2448C

N



OTHER STORE DISPLAYS

CHAPTER	DIVISION	CONTENTS
N	01	LADDER SYSTEM
	02	MINI-LADDER SYSTEM
	03	ARCADE COSTUMERS
	04	SATIN FINISH

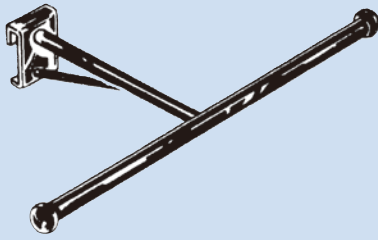

STRAIGHT HANGBAR ATTACHMENT

40" L, protrudes 12" from tower.

- # LL671-B Matte black
- # LL671-W Gloss white

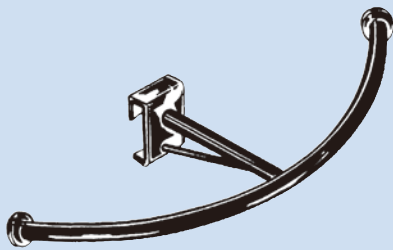

CURVED HANGBAR ATTACHMENT

Protrudes 12" from tower. Provides 40" of hanging space for your garments.

- # LL672-B Matte black
- # LL672-W Gloss white

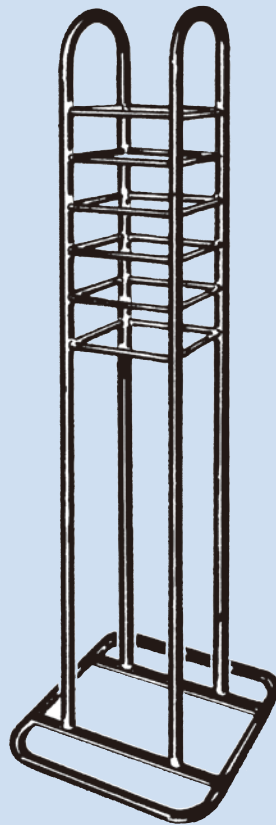

TWIN TOWER DISPLAY

Unit is 67" high with 24" square base. Constructed of 1 1/4" round tubing with 5/8" rungs on 4 3/8" centers.

- # LL67-B Matte black
- # LL67-W Gloss white

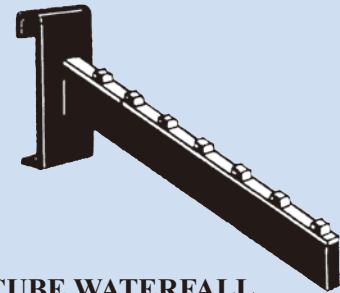

7 CUBE WATERFALL

12" L with 7 cubes. Constructed of 1/2" x 1 1/2" rectangular tubing. Top strip with cubes chrome plated to prevent scratching.

- # LL7C-B Matte black
- # LL7C-W Gloss white



12" FACEOUT

12" L, Constructed of 1/2" x 1 1/2" rectangular tubing. Chrome strip on top to prevent scratching.

- # LL12S-B Matte black
- # LL12S-W Gloss white

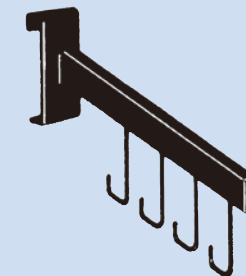

4 HOOK WATERFALL

12" L with 4 hooks. Constructed of 1/2" x 1 1/2" rectangular tubing.

- # LL4H-B Matte black
- # LL4H-W Gloss white

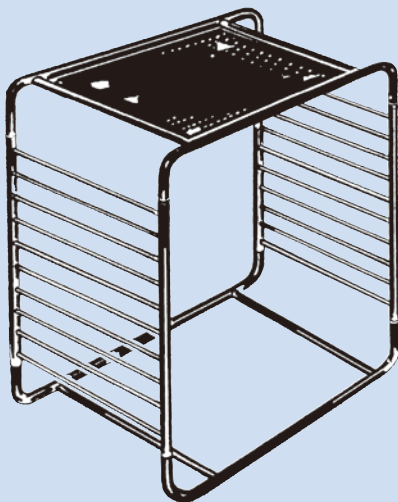

CENTER FLOOR RACK

Unit is 56" high x 24" deep constructed of 1 1/4" round tubing with 5/8" rungs on 4 3/8" centers.

- # LL482-B Matte black
- # LL482-W Gloss white

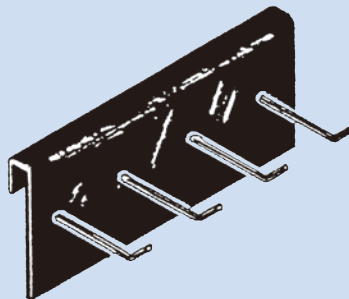

4 HOOK BELT OR TIE DISPLAYER

Includes 4pc 4" L hooks placed on 3" centers.

- # LLBT-B Matte black
- # LLBT-W Gloss white

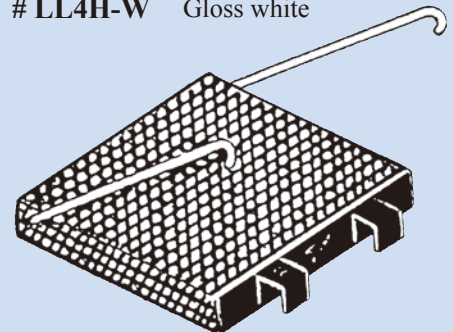

END SHELF

21" wide x 14" deep.

- # LL121-B Matte black
- # LL121-W Gloss white



LADDER SYSTEM

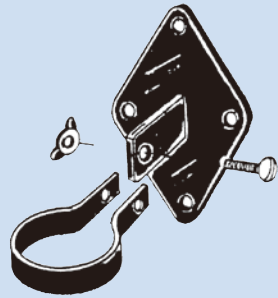
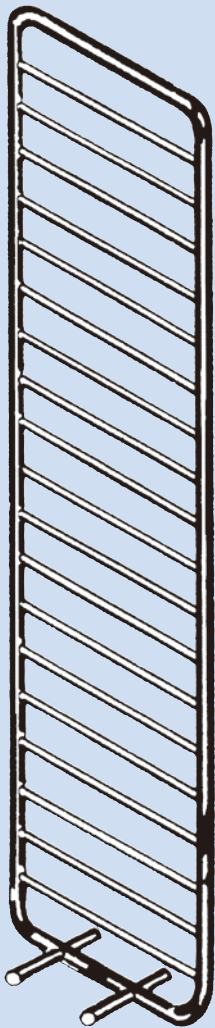

LADDER MOUNT BRACKETS

Wall mount

- # LLB-B Matte black
- # LLB-W Gloss white



LADDER BRACKETS

For attaching to universal standards
1/2" slots on 1" centers

- # LLS-B Matte black
- # LLS-W Gloss white

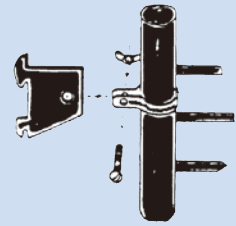

LADDER BRACKETS

For attaching to heavy duty standards
1" slots on 2" centers

- # LLR-B Matte black
- # LLR-W Gloss white



12" FACEOUT

12" L, Constructed of 1/2" x 1 1/2" rectangular tubing. Chrome strip on top to prevent scratching.

- # LH12S-B Matte black
- # LH12S-W Gloss white

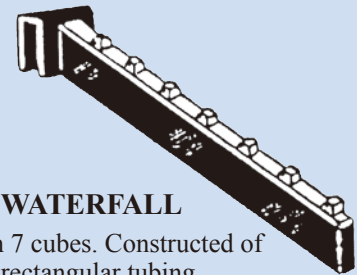

7 CUBE WATERFALL

12" L with 7 cubes. Constructed of 1/2" x 1 1/2" rectangular tubing. Top strip with cubes chrome plated to prevent scratching.

- # LH7C-B Matte black
- # LH7C-W Gloss white

LADDER FIN

Units are 90" high x 20" deep. Constructed of 1 1/4" round tubing with 5/8" rungs on 4 3/8" centers.

- # LL90-B Matte black
- # LL90-W Gloss white

WATERFALL MOUNT CROSSBAR

constructed of 1/2" x 1 1/2" rectangular tubing and mounts between rungs on 48" centers.

- # LL40-B Matte black
- # LL40-W Gloss white

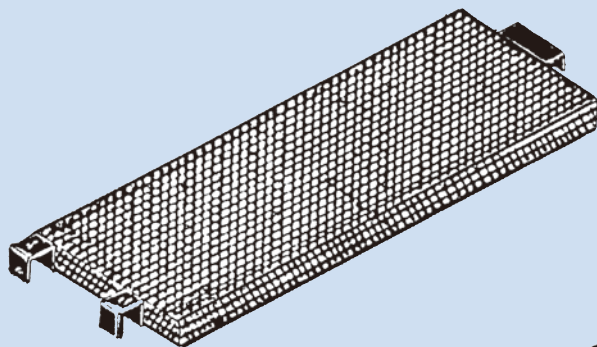

PERFORATED METAL SHELF

48" x 14" deep

- # LL1448-B Matte black
- # LL1448-W Gloss white

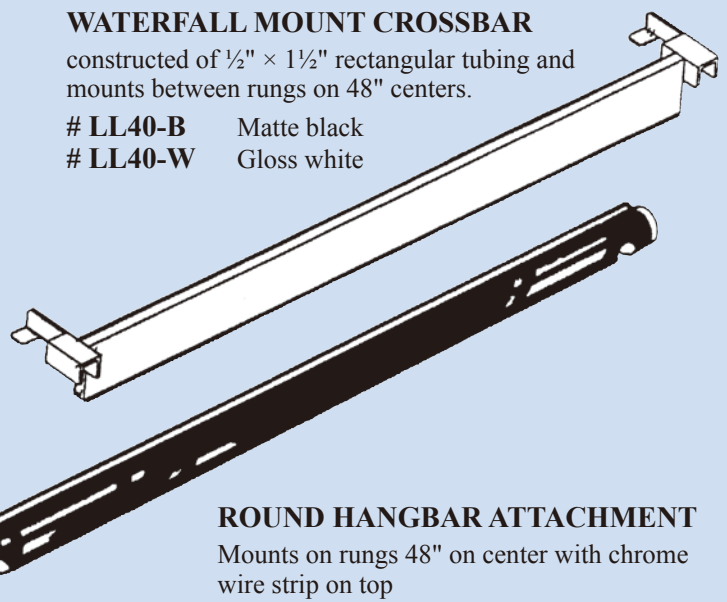

ROUND HANGBAR ATTACHMENT

Mounts on rungs 48" on center with chrome wire strip on top

- # LL42-B Matte black
- # LL42-W Gloss white

MINI-LADDER SYSTEM

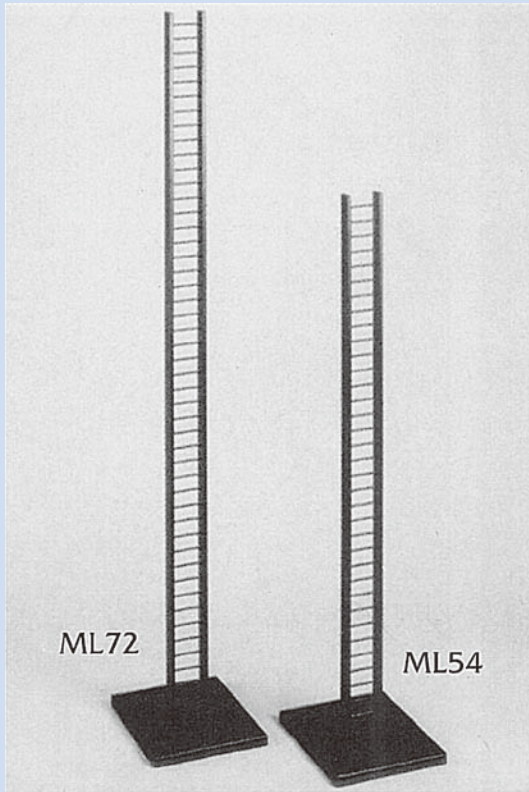

MINI-LADDER SYSTEM

Includes Post and 12" x 15" Metal Base with 5.0 mm thick.

Item	Size	Finish
# ML54	54"H	Chrome
# ML54-MB	54"H	Matte Black
# ML54-MW	54"H	Matte White
# ML72	72"H	Chrome
# ML72-MB	72"H	Matte Black
# ML72-MW	72"H	Matte White

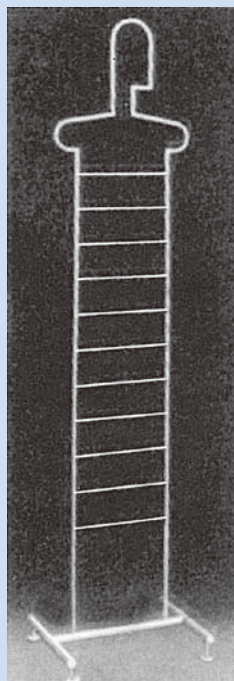
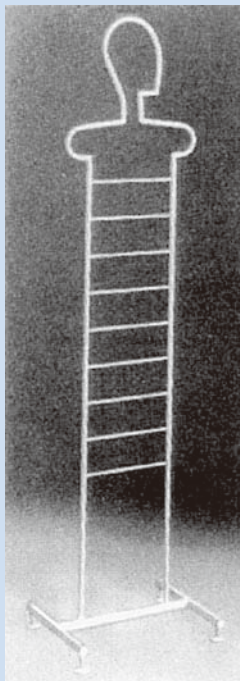

LADDER MANNEQUINS

	Men's	Ladies
Overall height:	72"	69"
Shoulder width:	17"	16"
Ladder rung width: (inside dimension)	11"	10"

MEN'S

- # **FF61-B** Black epoxy
- # **FF61-W** White epoxy

LADIES

- # **FF60-B** Black epoxy
- # **FF60-W** White epoxy

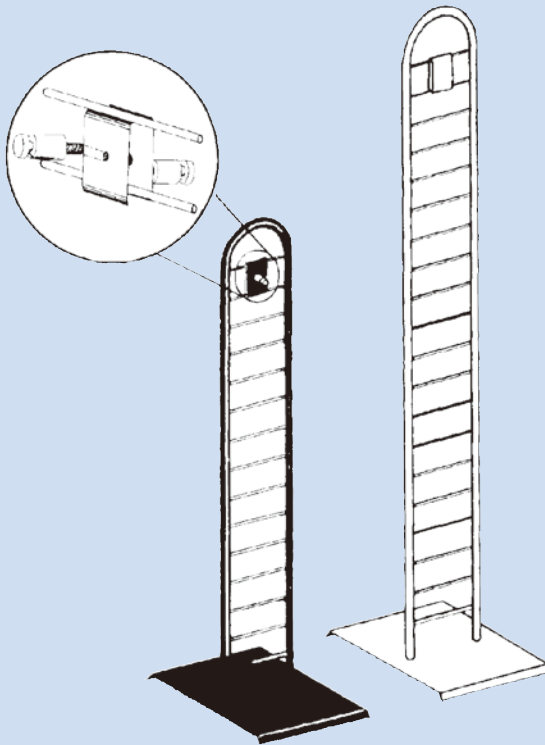

ARCADE LADDER DISPLAYER

Made of 1" round tubing with 1/4" rungs
on 3" center. 12"W × 14"D base

Finish available:

Glossy white/matte black

2-sided puck for hanging

AM200 8" × 66"

AM210 8" × 48"

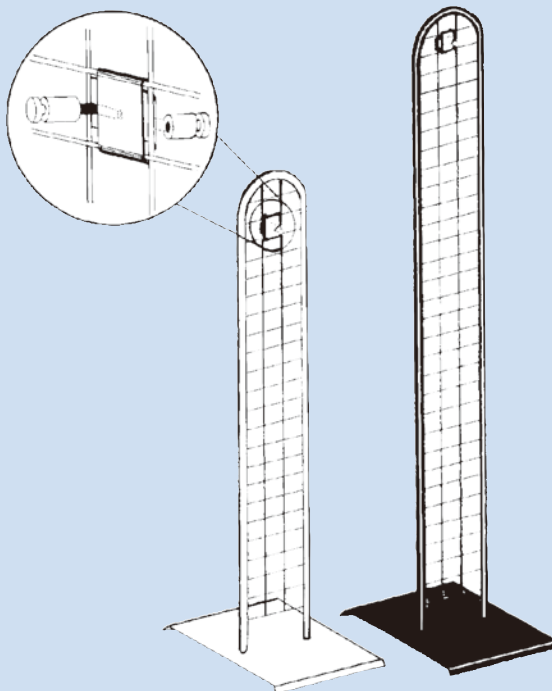

ARCADE GRID DISPLAYER

Made of 1" round tubing with 1/8" dia.
wire 2"× 2" pattern 12"W × 14"D base

Finish available:

Glossy white/matte black

2-sided puck for hanging

AM100 8" × 66"

AM110 8" × 48"

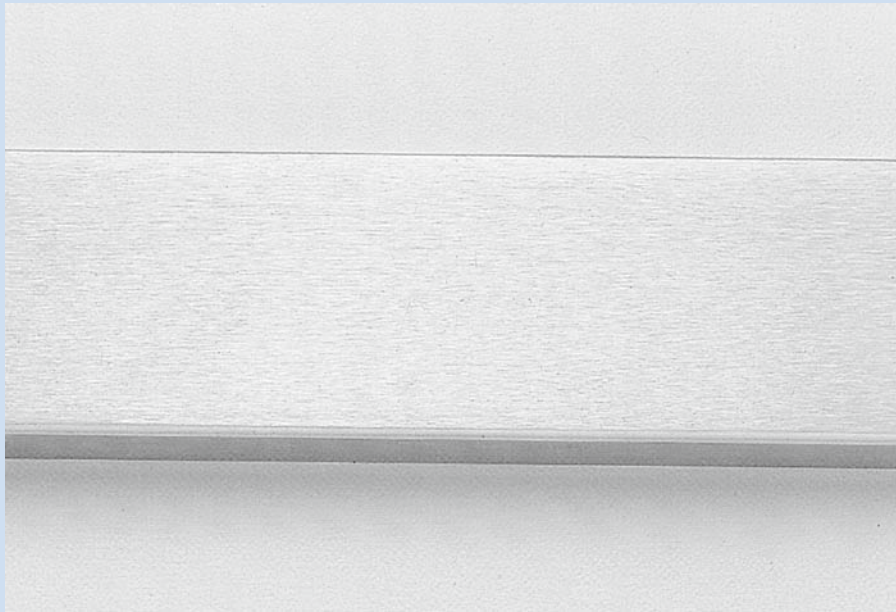

SATIN CHROME FINISH (GRIT #180)

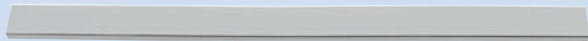

1/2"×1-1/2" RECTANGULAR TUBING

17 Gauge, Satin Chrome

RT2-SC 2"L

RT4-SC 4"L

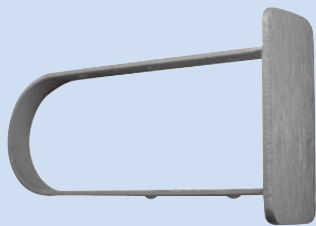

END CAP

For 1/2"× 1-1/2" rectangular tubing
Satin Chrome

EC-SC

ECX-SC (with 1" extension)

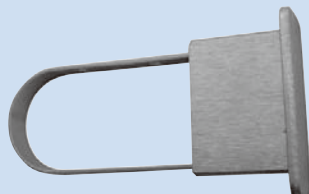



SATIN FINISH



WEDGE TYPE SHELF BRACKET

To fit universal 1/2" slots on 1" centers
Satin Chrome

4010-12SC 12"L

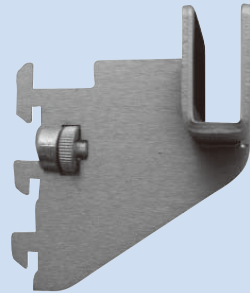

BLADE BRACKET FOR HOLDING RECTANGULAR TUBING

To fit universal 1/2" slots on 1" centers
With tightening screw
Satin Chrome

BS3-SC 3"L



ALL-PURPOSE BLADE BRACKET FOR SNAP-ON ATTACHMENT

To fit universal 1/2" slots on 1" centers
With nylon stabilizer
Satin Zinc

HBS12-SZ 12"L

HBS14-SZ 14"L



BRACKET FOR HOLDING RECTANGULAR TUBING

To fit universal 1/2" slots on 1" centers,
With tightening screws.
Made of 1/2" x 1-1/2" rectangular tubing
Satin Chrome

CR12R-SC 12"L



BRACKETS FOR WOOD SHELVES

To fit universal 1/2" slots on 1" centers
Satin Zinc

BWSC12-SZ # BWSL12-SZ # BWSR12-SZ
Center ~ 12" Left ~ 12" Right ~ 12"

BWSC14-SZ # BWSL14-SZ # BWSR14-SZ
Center ~ 14" Left ~ 14" Right ~ 14"



STRAIGHT FACEOUT

To fit universal 1/2" slots on 1" centers
Made of 1/2" x 1-1/2" rectangular tubing
Satin Chrome

RDW12-SC 12"L

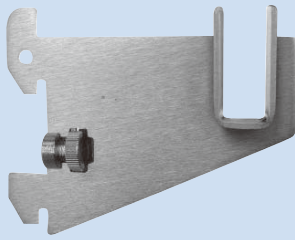

HEAVY DUTY BLADE BRACKET FOR HOLDING RECTANGULAR TUBING

To fit heavy duty 1" slots on 2" centers
With tightening screw, Satin Chrome

BR3-SC 3"L

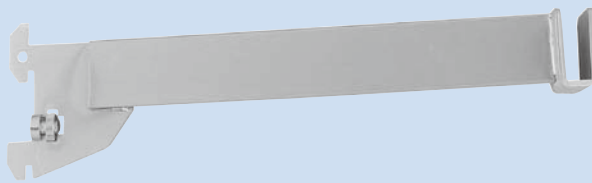

HEAVY DUTY BRACKET FOR HOLDING RECTANGULAR TUBING

To fit heavy duty 1" slots on 2" centers
With tightening screw
Made of 1/2" x 1-1/2" rectangular tubing
Satin Chrome

GR8R-SC 8"L
GR12R-SC 12"L



HEAVY DUTY BLADE BRACKET FOR SNAP-ON ATTACHMENT

To fit heavy duty 1" slots on 2" centers
With tightening screw
Satin Chrome

HBR12-SC 12"L



STRAIGHT FACEOUT

To fit heavy duty 1" slots on 2" centers
Made of 1/2" x 1-1/2" rectangular tubing
Satin Chrome

RR12-SC 12"L

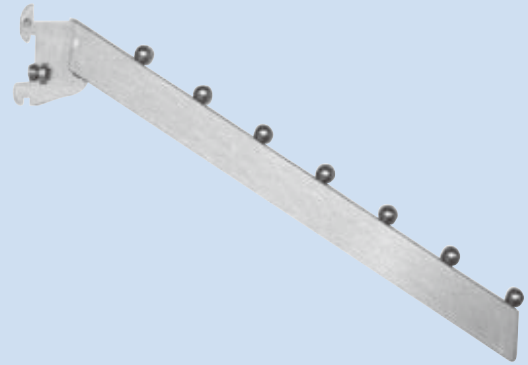

7 BALL WATERFALL

To fit heavy duty 1" slots on 2" centers
Made of 1/2" x 1-1/2" rectangular tubing
Satin Chrome

RR7B-SC 17"L

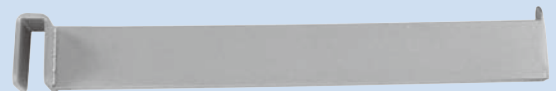

STRAIGHT FACEOUT

Horizontal mount on 1/2" x 1-1/2" rect. tubing
Made of 1/2" x 1-1/2" rectangular tubing
Satin Chrome

RH6S-SC
RH12S-SC

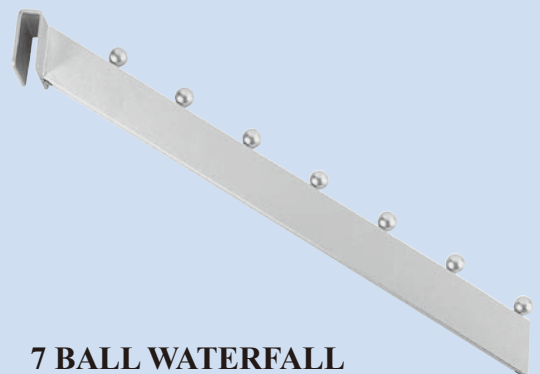

7 BALL WATERFALL

Horizontal mount on 1/2" x 1-1/2" rect. tubing
Made of 1/2" x 1-1/2" rectangular tubing
Satin Chrome

RH7B-SC



SATIN FINISH

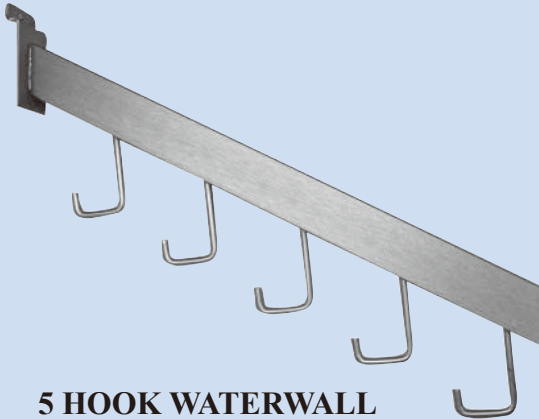

5 HOOK WATERWALL

To fit on slatwall
Made of 1/2" x 1-1/2" rectangular tubing
Satin Chrome

RW5H-SC 17"L



STRAIGHT FACEOUT

To fit on slatwall
Made of 1/2" x 1-1/2" rectangular tubing
Satin Chrome

RW12-SC 12"L

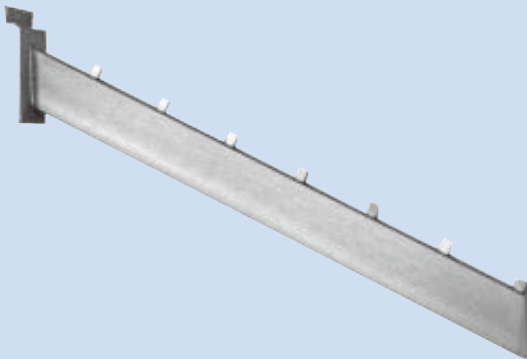

7 CUBE WATERWALL

To fit on slatwall
Made of 1/2" x 1-1/2" rectangular tubing
Satin Chrome

RW7C-SC 15"L



KNIFE SHELF BRACKET

To fit on slatwall
Satin Chrome

SW12KB-SC 12"L

SW14KB-SC 14"L



SLATWALL HOOKS

1/4" wire with rounded tips
Back plate in Satin Chrome

SWH4-SC 4"L

SWH6-SC 6"L

SWH8-SC 8"L

SWH10-SC 10"L

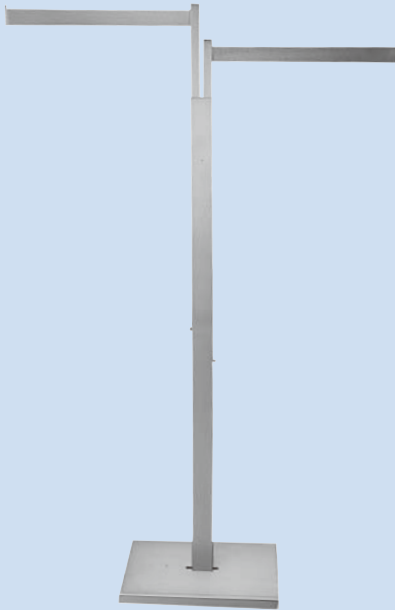

2 ARM RACK

- 2 Straight arms 16"L, made of 1/2" × 1-1/2" rect tubing
- Arms adjust from 48" to 72" every 3"
- Sturdy 12" × 15" weighted base
- Upright made of single 1" × 2" rect tubing
- Satin Chrome

R85-1SC



ADJUSTABLE ROUND RACK

- Hangrail made of 1/2" × 1 1/2" rect tubing
- Adjusts from 48" to 66" every 3"
- Base made of 1" square tubing
- Folds flat for easy storage
- Satin Chrome

RR36-SC 36" Dia

RR42-SC 42" Dia

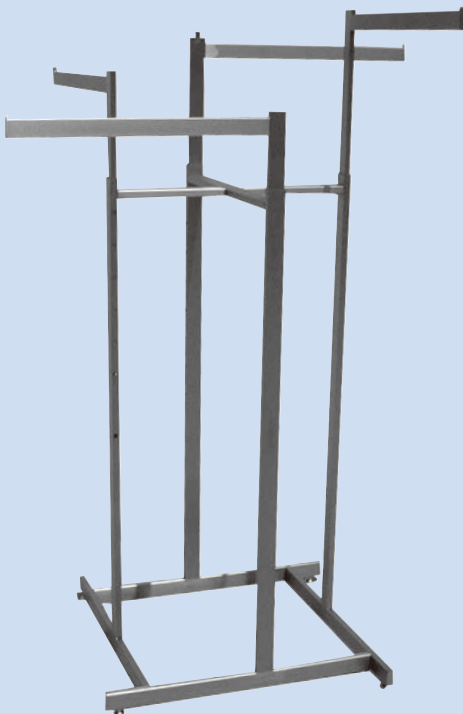

SUPER QUAD 4 ARM RACK

- 4 Straight arms 22"L, made of 1/2" × 1-1/2" rect tubing
- Arms adjust from 48" to 72" every 3"
- Base and frames made of 5/8" × 1-5/8" rect tubing
- 3/8" threaded fitting on 1 arm to accept card frame
- Satin Chrome

RR22C-SC

O



OTHER STORE SUPPLIES

CHAPTER	DIVISION	CONTENTS
O	01	RETRIEVER
	02	SHOPPING BASKET
	03	SHOPPING CART
	04	BARRIER
	05	CROWD CONTROL
	06	SCANNER HOOK
	07	MULTIPURPOSE SHELF
	08	LED SIGN
	09	SHOE STOOL
	10	UMBRELLA RACK & PACKING SERIES



HANGER RETRIEVER

Steel tube, chrome finish
With PVC Handle
66" Long

AH

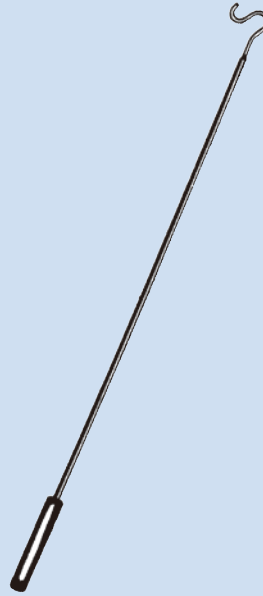

HANGER RETRIEVER

Steel tube, chrome finish
With Wooden handle
66" Long

AH-1-1

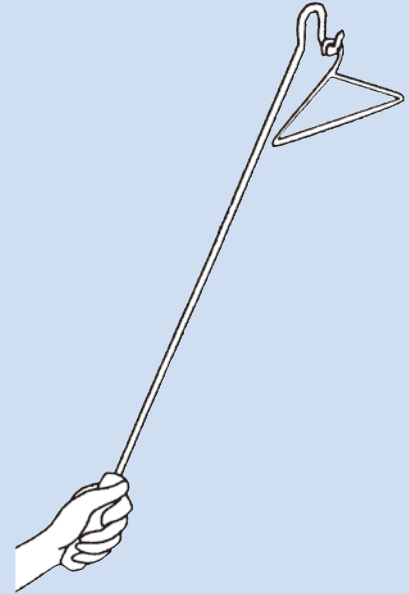

HANGER RETRIEVER

Steel tube, chrome finish
With Wooden handle
54" Long

AH-1

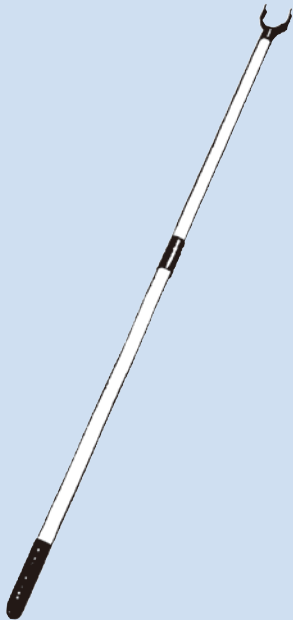

TELESCOPING RETRIEVER POLE

Two 30"L. Sections
Black finish with Red hook

TRP-1

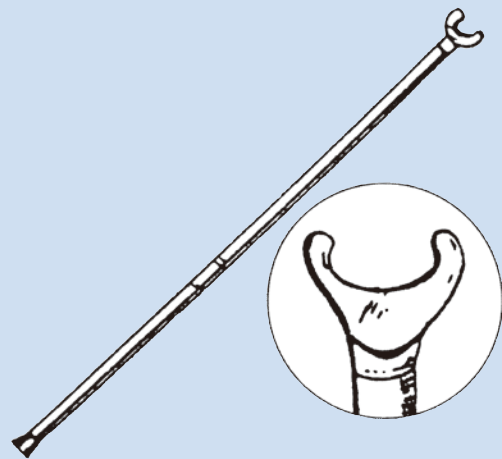

REACHING RODS

Aluminum rod
72" Long

RHH

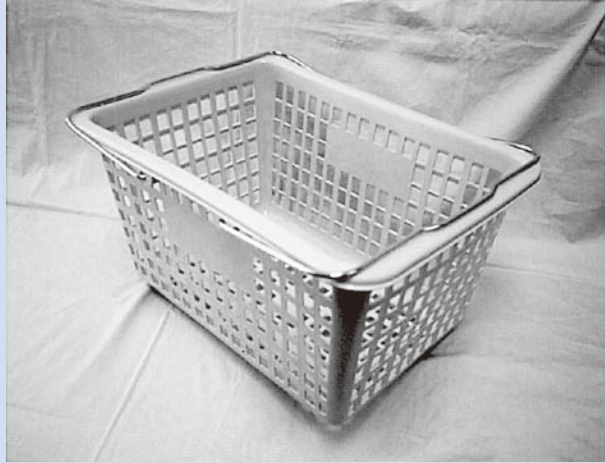

PLASTIC SHOPPING BASKET

W/Double metal wire handle
Size : 15³/₄"L × 11¹/₈"W × 9"H

- # HB16119-B Blue
- # HB16119-G Green
- # HB16119-R Red



PLASTIC SHOPPING BASKET

W/Double metal wire handle
Size : 18³/₄"L × 13³/₄"W × 9³/₄"H

- # HB191410-B Blue
- # HB191410-G Green
- # HB191410-R Red



SHOPPING BASKET ACCESSORIES

MAY / 2011



WIRE BASKET STAND FOR BASKET (HB16119)

Zinc plated
14" long, 11-1/4" wide, 6" leg
WBS



SHOPPING CART



ITEM#	VOLUME (Cubic Inch)	CAPACITY (Pound)	CASTER (Inch)	MEASUREMENTS (Inch)								
				A	B	H	W	F	G	L	M	N
SXC-50	3051	88	3	26-3/4	7-1/2	33-9/16	16-9/16	10-5/16	15-3/8	26-3/4	18-11/16	15-3/8
SXC-60A	3661	110	4	25-9/16	8-1/4	38-9/16	18-1/2	10-9/16	18	29-1/2	20-1/16	16-1/4
SXC-80A	4881	132	4	27-15/16	9-1/4	38	20-7/8	9-7/16	19-5/16	31-7/8	22-15/16	18-1/8
SXC-100A	6101	165	4	29-15/16	9-1/4	37-15/16	20-11/16	11-1/4	19-5/16	34-5/8	24-7/8	18-5/16

Finish : Chrome

Color of plastic components: Red

Safety belt and child seat: SXC-60A/SXC-80A/SXC-100A are included.



AMERICAN STYLE SHOPPING CART WITH TUBE BASE



ITEM#	VOLUME (Cubic Inch)	CAPACITY (Pound)	CASTER (Inch)	MEASUREMENTS (Inch)						
				L	L1	W1	W2	H1	H2	H3
YB-60A	3661	110	4	29-15/16	19-11/16	8-1/4	16-15/16	10-5/8	29-5/16	18-1/8
YB-80A	4881	132	4	32-5/16	21-5/8	9-7/16	17-11/16	11-13/16	28-3/8	18-7/8
YB-100A	6101	165	4	34-1/4	22-1/16	9-7/16	19-1/8	11	28-3/8	18-7/8
YB-120A	7321	176	4	34-5/8	26	9-7/16	19-11/16	12-5/8	31-5/16	21-1/4
YB-125A	7626	198	5	35-7/16	26	9-7/16	19-11/16	12-13/16	31-1/2	20-1/2
YB-150A	9152	220	5	39	25-3/16	9-7/16	20-1/16	13-3/4	31-7/8	21-1/4
YB-180A	10982	264	5	39-3/8	25-3/16	9-7/16	20-1/16	16-1/8	33-7/16	23-1/4
YB-210A	12812	286	5	39-3/4	31-1/2	10-5/8	22-13/16	16-1/8	34-1/4	25-3/16
YB-240A	14642	330	5	43-11/16	31-1/2	10-5/8	22-13/16	18-1/2	34-5/8	26-3/4

- All shopping carts can be made in Zinc finish w/powder coating of Clear, Gray, Black, Blue, Red, or Green color.
- Chrome finish is only available for item #YB-60A thru #YB-150A.
- All shopping carts are included with safety belt & child seat.
- The color of all plastic components is red.

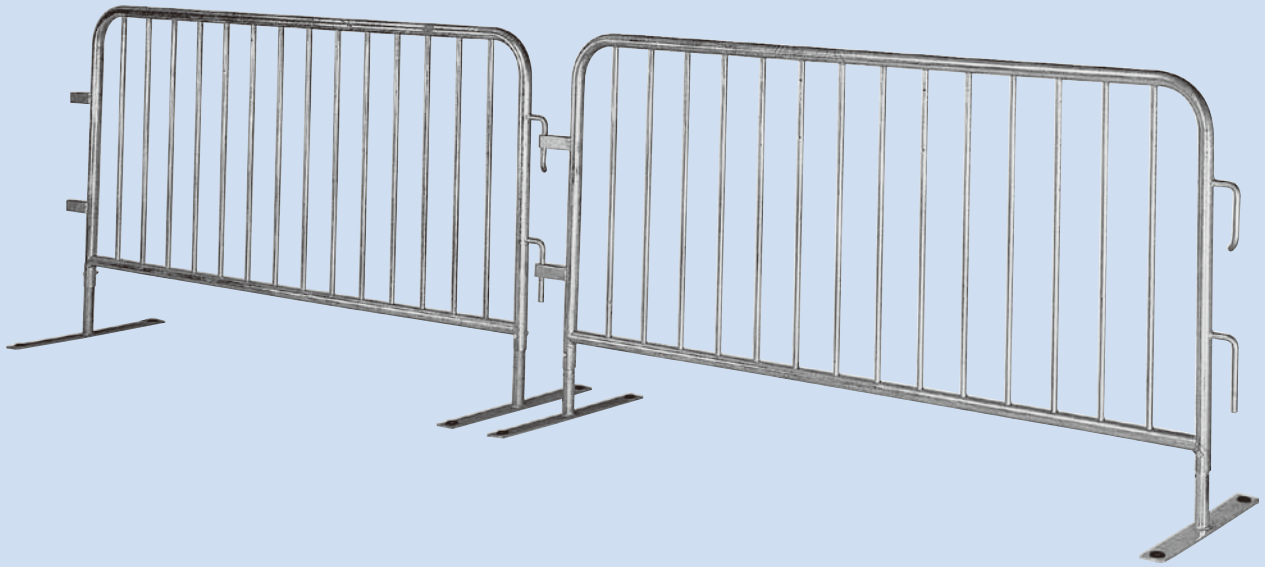

PORTABLE TRAFFIC BARRIER

- Barrier: 78-1/2" Long
- 2 Flat Legs: 23" x 2-1/2" with Bolt/Nut & Rubber Gaskets
- Frame Tube: 1-1/2" dia x 2.0 mm thickness
- Vertical Bar Tube: 5/8" dia x 1.2 mm thickness
- Leg Tube: 34 mm dia x 3.0 mm thickness
- Hot-dipped galvanized steel done to meet marine standards, provide superior weather protection and allow for permanent outdoor storage
- Uniquely designed base legs allow positioning of adjacent units at any desired angle

B802



All Way Retractable Tape Queue Stand (Tape Length:200cm)

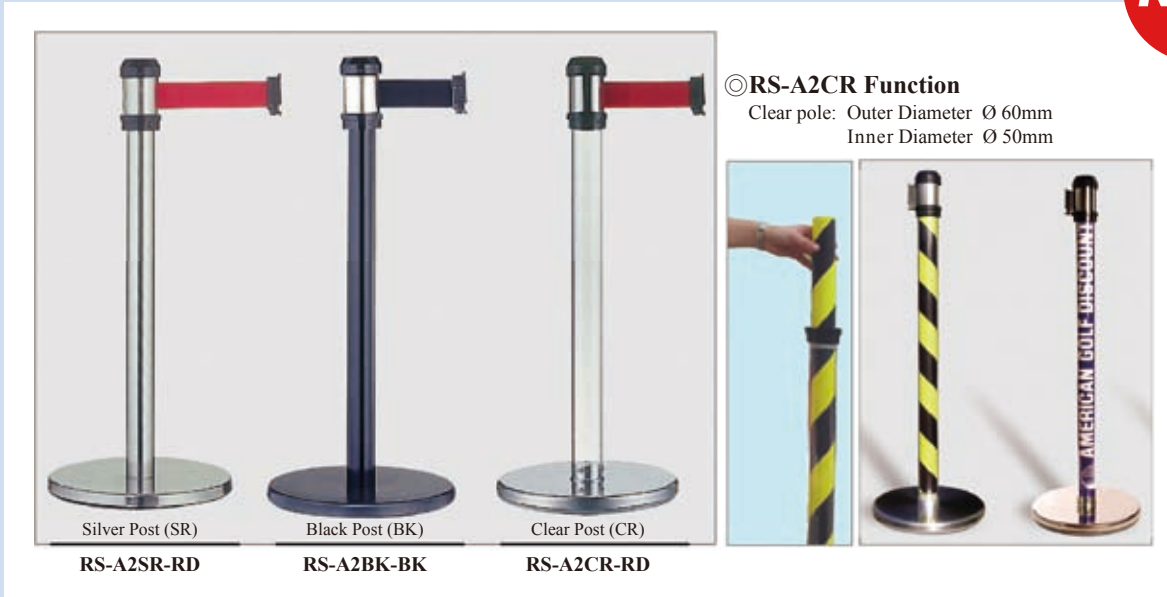
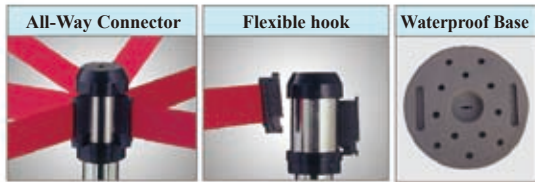
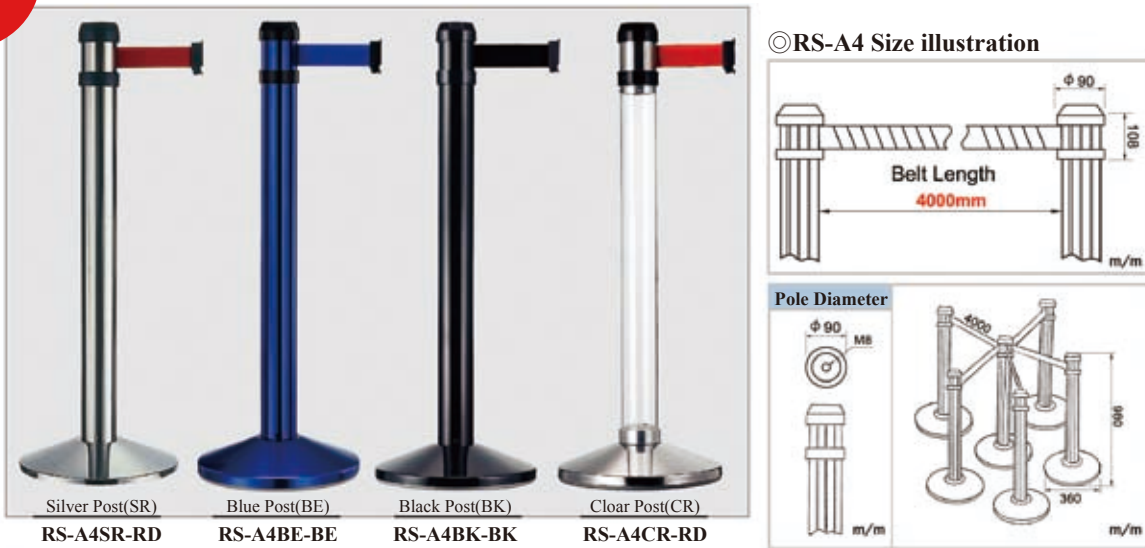

Photo	Item#	Description
	<p>RS-A2SR-RD</p> <p>RS-A2BK-RD</p> <p>RS-A2BK-BE</p> <p>RS-A2BK-BK</p> <p>RS-A2CR-RD</p>	<ul style="list-style-type: none"> All-Way Retractable Queue Stand Tape Length : 200cm Total Height : 100cm Steel Post Finish : Black, Silver, Clear Plastic Weighted Base
	RW-C1	<ul style="list-style-type: none"> Black Plastic Wall Clip Including Wall Receiver & Screw Accessory
	RS-A4B	<ul style="list-style-type: none"> Black Plastic Signholder to fit on Retractable Queue Stand With PVC Face Inserts Size : 305 mm x 220 mm Adjustable for both Portrait and Landscape orientations
	SW-R1SA	<ul style="list-style-type: none"> Stainless Steel post and base Portable Post : 92.7cm H 14" base with plastic loader
	SW-R180	<ul style="list-style-type: none"> Red Velvet Rope : 180cm L
	SW-R150	<ul style="list-style-type: none"> Red Velvet Rope : 150cm L



All Way Retractable Tape Queue Stand (Tape Length:400cm)



RS-A4CR Features:
 Clear post can put in beverage can, company's brand, advertising, safe sign and various advertising display

◎Accessories (Optional)



Wall Mounted Retractable Tape Barriers (Tape Length:400cm/200cm)

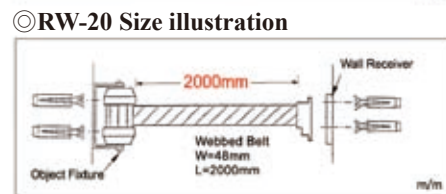
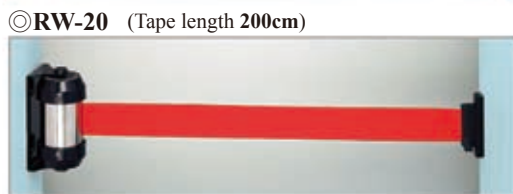
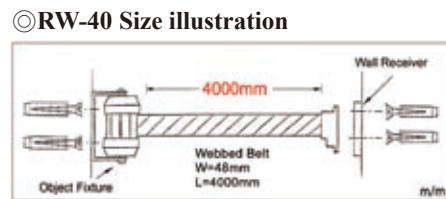
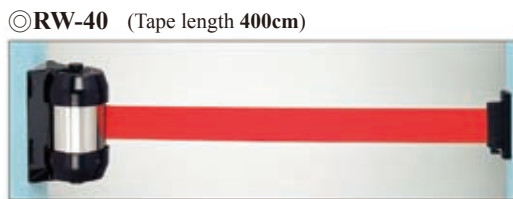

◎Features



◎Connecting/Releasing Tape Way

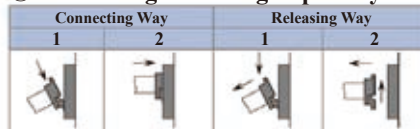

◎RW-40/RW-20 Accessories

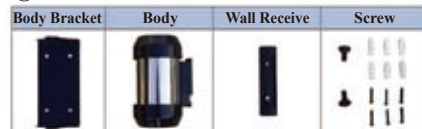

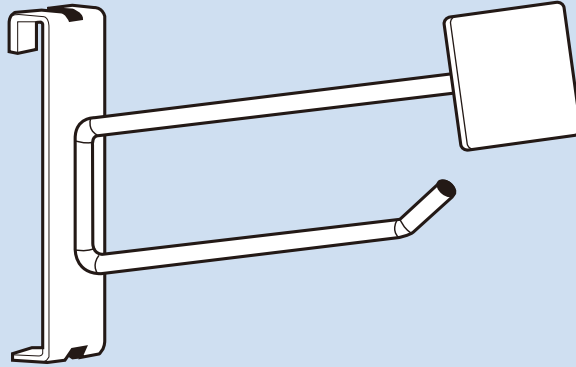

GRIDWALL SCANNER HOOK ZINC

Length	Metal Plate: 1-3/8"×3"×1.5mm Wire Dia. 0.187"	Metal Plate: 1-3/8"×3"×1.5mm Wire Dia. 0.225"	Metal Plate: 1-3/8"×2-1/8"×1.5mm Wire Dia. 0.187"	Metal Plate: 1-3/8"×2-1/8"×1.5mm Wire Dia. 0.225"
4"	M13G4-ME	M13G4-HD	M12G4-ME	M12G4-HD
6"	M13G6-ME	M13G6-HD	M12G6-ME	M12G6-HD
8"	M13G8-ME	M13G8-HD	M12G8-ME	M12G8-HD
10"	M13G10-ME	M13G10-HD	M12G10-ME	M12G10-HD
12"	M13G12-ME	M13G12-HD	M12G12-ME	M12G12-HD

GRIDWALL SCANNER HOOK CHROME

Length	Metal Plate: 1-3/8"×3"×1.5mm Wire Dia. 0.187"	Metal Plate: 1-3/8"×3"×1.5mm Wire Dia. 0.225"	Metal Plate: 1-3/8"×2-1/8"×1.5mm Wire Dia. 0.187"	Metal Plate: 1-3/8"×2-1/8"×1.5mm Wire Dia. 0.225"
4"	M13G4-ME-C	M13G4-HD-C	M12G4-ME-C	M12G4-HD-C
6"	M13G6-ME-C	M13G6-HD-C	M12G6-ME-C	M12G6-HD-C
8"	M13G8-ME-C	M13G8-HD-C	M12G8-ME-C	M12G8-HD-C
10"	M13G10-ME-C	M13G10-HD-C	M12G10-ME-C	M12G10-HD-C
12"	M13G12-ME-C	M13G12-HD-C	M12G12-ME-C	M12G12-HD-C



SCANNER HOOK

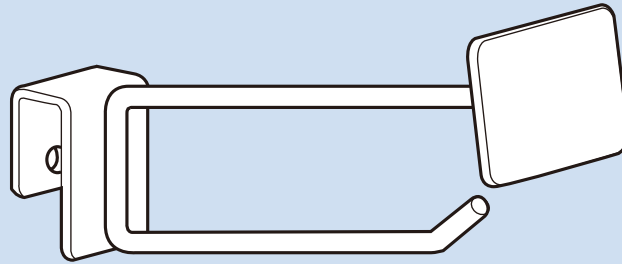

HANGRAIL SCANNER HOOK ZINC

Length	Metal Plate: 1-3/8"×3"×1.5mm Wire Dia. 0.187"	Metal Plate: 1-3/8"×3"×1.5mm Wire Dia. 0.225"	Metal Plate: 1-3/8"×2-1/8"×1.5mm Wire Dia. 0.187"	Metal Plate: 1-3/8"×2-1/8"×1.5mm Wire Dia. 0.225"
4"	M13H4-ME	M13H4-HD	M12H4-ME	M12H4-HD
6"	M13H6-ME	M13H6-HD	M12H6-ME	M12H6-HD
8"	M13H8-ME	M13H8-HD	M12H8-ME	M12H8-HD
10"	M13H10-ME	M13H10-HD	M12H10-ME	M12H10-HD
12"	M13H12-ME	M13H12-HD	M12H12-ME	M12H12-HD

HANGRAIL SCANNER HOOK CHROME

Length	Metal Plate: 1-3/8"×3"×1.5mm Wire Dia. 0.187"	Metal Plate: 1-3/8"×3"×1.5mm Wire Dia. 0.225"	Metal Plate: 1-3/8"×2-1/8"×1.5mm Wire Dia. 0.187"	Metal Plate: 1-3/8"×2-1/8"×1.5mm Wire Dia. 0.225"
4"	M13H4-ME-C	M13H4-HD-C	M12H4-ME-C	M12H4-HD-C
6"	M13H6-ME-C	M13H6-HD-C	M12H6-ME-C	M12H6-HD-C
8"	M13H8-ME-C	M13H8-HD-C	M12H8-ME-C	M12H8-HD-C
10"	M13H10-ME-C	M13H10-HD-C	M12H10-ME-C	M12H10-HD-C
12"	M13H12-ME-C	M13H12-HD-C	M12H12-ME-C	M12H12-HD-C

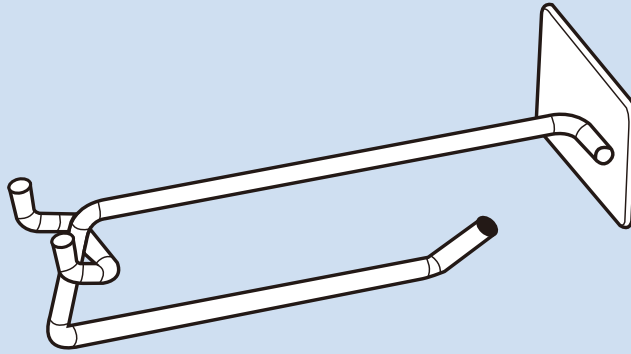

PEGBOARD SCANNER HOOK ZINC

Length	Metal Plate: 1-3/8"×3"×1.5mm Wire Dia. 0.187"	Metal Plate: 1-3/8"×3"×1.5mm Wire Dia. 0.225"	Metal Plate: 1-3/8"×2-1/8"×1.5mm Wire Dia. 0.187"	Metal Plate: 1-3/8"×2-1/8"×1.5mm Wire Dia. 0.225"
4"	M13P4-ME	M13P4-HD	M12P4-ME	M12P4-HD
6"	M13P6-ME	M13P6-HD	M12P6-ME	M12P6-HD
8"	M13P8-ME	M13P8-HD	M12P8-ME	M12P8-HD
10"	M13P10-ME	M13P10-HD	M12P10-ME	M12P10-HD
12"	M13P12-ME	M13P12-HD	M12P12-ME	M12P12-HD

PEGBOARD SCANNER HOOK CHROME

Length	Metal Plate: 1-3/8"×3"×1.5mm Wire Dia. 0.187"	Metal Plate: 1-3/8"×3"×1.5mm Wire Dia. 0.225"	Metal Plate: 1-3/8"×2-1/8"×1.5mm Wire Dia. 0.187"	Metal Plate: 1-3/8"×2-1/8"×1.5mm Wire Dia. 0.225"
4"	M13P4-ME-C	M13P4-HD-C	M12P4-ME-C	M12P4-HD-C
6"	M13P6-ME-C	M13P6-HD-C	M12P6-ME-C	M12P6-HD-C
8"	M13P8-ME-C	M13P8-HD-C	M12P8-ME-C	M12P8-HD-C
10"	M13P10-ME-C	M13P10-HD-C	M12P10-ME-C	M12P10-HD-C
12"	M13P12-ME-C	M13P12-HD-C	M12P12-ME-C	M12P12-HD-C



SCANNER HOOK

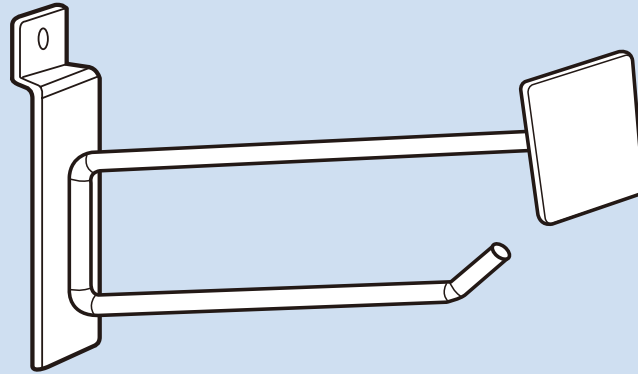

SLATWALL SCANNER HOOK ZINC

Length	Metal Plate: 1-3/8"×3"×1.5mm Wire Dia. 0.187"	Metal Plate: 1-3/8"×3"×1.5mm Wire Dia. 0.225"	Metal Plate: 1-3/8"×2-1/8"×1.5mm Wire Dia. 0.187"	Metal Plate: 1-3/8"×2-1/8"×1.5mm Wire Dia. 0.225"
4"	M13S4-ME	M13S4-HD	M12S4-ME	M12S4-HD
6"	M13S6-ME	M13S6-HD	M12S6-ME	M12S6-HD
8"	M13S8-ME	M13S8-HD	M12S8-ME	M12S8-HD
10"	M13S10-ME	M13S10-HD	M12S10-ME	M12S10-HD
12"	M13S12-ME	M13S12-HD	M12S12-ME	M12S12-HD

SLATWALL SCANNER HOOK CHROME

Length	Metal Plate: 1-3/8"×3"×1.5mm Wire Dia. 0.187"	Metal Plate: 1-3/8"×3"×1.5mm Wire Dia. 0.225"	Metal Plate: 1-3/8"×2-1/8"×1.5mm Wire Dia. 0.187"	Metal Plate: 1-3/8"×2-1/8"×1.5mm Wire Dia. 0.225"
4"	M13S4-ME-C	M13S4-HD-C	M12S4-ME-C	M12S4-HD-C
6"	M13S6-ME-C	M13S6-HD-C	M12S6-ME-C	M12S6-HD-C
8"	M13S8-ME-C	M13S8-HD-C	M12S8-ME-C	M12S8-HD-C
10"	M13S10-ME-C	M13S10-HD-C	M12S10-ME-C	M12S10-HD-C
12"	M13S12-ME-C	M13S12-HD-C	M12S12-ME-C	M12S12-HD-C



HEAVY-DUTY MULTIPURPOSE SHELF

- Shelf can be reversible for 30° down slant or straight.
- Multi-choice of brackets for fitting on panel type.
- Made of 4.8mm wire.

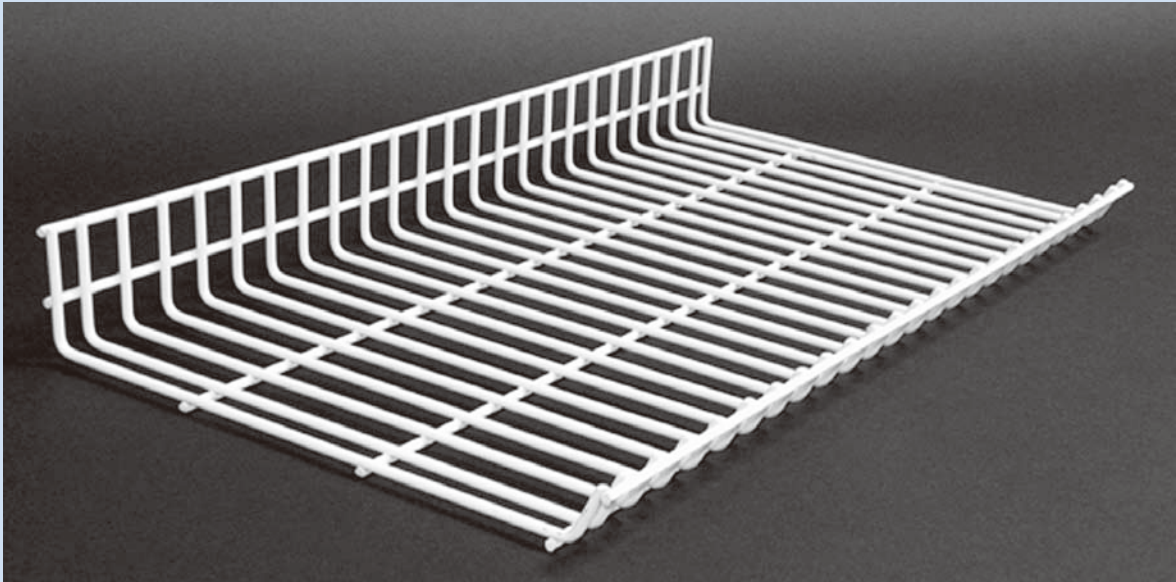

Size
12" × 24"
12" × 36"

Chrome
MS24
MS36

Black
MS24B
MS36B

White
MS24W
MS36W



GRIDWALL BRACKET

1" × 2"
GP Chrome
GP-B Black
GP-W White



SLATWALL BRACKET

1" × 2"
SP Chrome
SP-B Black
SP-W White

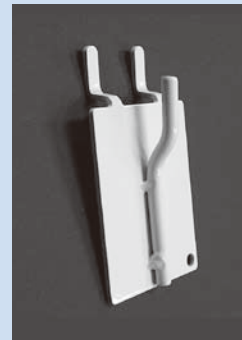

PEGBOARD BRACKET

1" × 2"
PP Chrome
PP-B Black
PP-W White

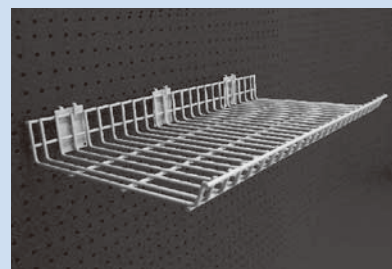
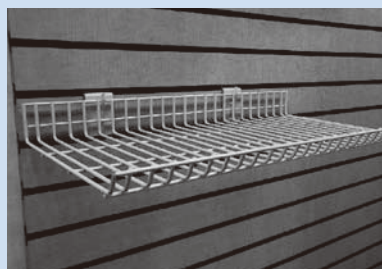
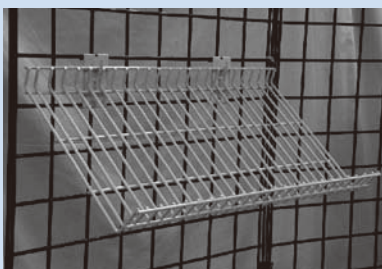



ANIMATED LED OPEN SIGNS

- Dimensions: 22" X 13"
- LED Bulb
- 2 Animation Functions-
Steady on
Chasing and flashing
- Lightweight, easy installation
- Operating voltage : 110V AC
- Indoor use only
- UL/CUL certified adapter
- Hanging hardware & chain included
- Custom LED signs are available upon request



NLO-01 5mm
NLO-01-1 8mm

Item #	Led Bulb Size
# NLO-01	5mm
# NLO-01-1	8mm
# NLO-02	5mm
# NLO-04	5mm



NLO-02



NLO-04



ANIMATED LED SIGNS



NLO-77



NLO-135



#NLO-320



NLO-321

- Dimensions: 22" X 13"
- LED Bulb Size: 5mm
- 2 Animation Functions-
Steady on
Chasing and flashing
- Lightweight, easy installation
- Operating voltage: 110V AC
- Indoor use only
- UL/CUL certified adapter
- Hanging hardware & chain included
- Custom LED signs are available upon request

LED MULTI-FUNCTION SIGNBOARD



Signboard Stand



O8-1G
22" × 28" LED MULTI-FUNCTION
ALUMINUM ALLOY SIGNBOARD
WITH STAND, GOLD FINISH.



O8-1S
22" × 28" LED MULTI-FUNCTION
ALUMINUM ALLOY SIGNBOARD
WITH STAND, SILVER FINISH.

- Specification:
 - Sign Frame: 22" × 28"
 - Total Height: 59" H
 - Pole: 31" × 1-1/2" Dia
 - Base: 14" Dia.
- Signboard Functions -
 - Flashing, Light-on, No-light.
 - Both Hand-writing and Poster are available.
- Power -
 - AC: 100V~240V, applied directly through adaptor.
 - DC: 7.5V, recharge the batteries through adaptor to store up power, no wire required.
 - Ten-hours recharging for seven hours with light-on and fourteen hours with flashing.
- UL / CUL / CE certified adapter.



LED MULTI-FUNCTION SIGNBOARD

Signboard for Retractable Tape Post Use



+



=



O8-2S
7" × 11" LED MULTI-FUNCTION
ALUMINUM ALLOY SIGNBOARD,
SILVER FINISH.
 Suitable For Tape Post Stand

RS-A2SR-RD
SILVER POST STAND
 Please See Our Page #O-05-01
 For The Detailed Specification.

- Signboard Functions -
 Flashing, Light-on, No-light.
 Both Hand-writing and Poster are available.
- Power -
 AC: 100V~240V, applied directly through adaptor.
 DC: 7.5V, recharge the batteries through adaptor to store up power, no wire required.
 Ten-hours recharging for seven hours with light-on and fourteen hours with flashing.
- UL / CUL / CE certified adapter.

LED MULTI-FUNCTION SIGNBOARD



Slant Type Wood Poster Stand and LED Signboard



+

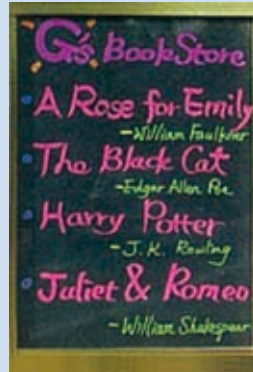

=



U4-1G
SLANT TYPE WOOD POSTER
STAND, GOLD FINISH.
 Size: 22"W × 35"D × 55"H

O8-3G
22" × 28" LED ALUMINUM ALLOY
SIGNBOARD, GOLD FINISH.



+



=



U4-1S
SLANT TYPE WOOD POSTER
STAND, SILVER FINISH.
 Size: 22"W × 35"D × 55"H

O8-3S
22" × 28" LED ALUMINUM ALLOY
SIGNBOARD, SILVER FINISH.

- Signboard Functions -
 Flashing, Light-on, No-light.
 Both Hand-writing and Poster are available.
- Power -
 AC: 100V~240V, applied directly through adaptor.
 DC: 7.5V, recharge the batteries through adaptor to store up power, no wire required.
 Ten-hours recharging for seven hours with light-on and fourteen hours with flashing.
- UL / CUL / CE certified adapter.



SHOE STOOL

- Black vinyl seat
- Black wooden veneer foot rest
- 1" Round tubing frame in chrome finish
- 29"L × 14-1/4"H

O9-1

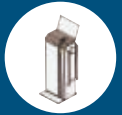

UMBRELLA PACKING MACHINE SERIES

● Short Polybag Holder (optional)

M1S

M1S Illustration

● Features:

- Alarm light to indicate the run-out of bags.

- Movable Handle.

- With wheels to move.

● The method of operation

(1) Insert umbrella direct the bottom

(2) Pull forward quickly to release.

SW-M1B (US Patent No.5,765,338)
Automatic Umbrella Packing Machine

- Non-electric, easy to operate. With wheels, easy to move.
- Takes only 2 seconds to pack umbrella.
- Able to pack 1,000 umbrellas per refillable unit.
- Beep and automatic flash indicate the run-out of bags.
- W30cm × D30cm × H119cm
- Weight: 15kgs

- # SW-M1B **NON-ELECTRIC AUTO UMBRELLA PACKING MACHINE**
- # M1-01-L **LONG POLYBAG USING FOR #SW-M1B, Box of 2,000pcs**
- # M1S **SHORT POLYBAG HOLDER USING WITH #SW-M1B**
- # M1-01-S **SHORT POLYBAG USING FOR #M1S, Box of 2000pcs**



Wet Umbrella Folding Rack

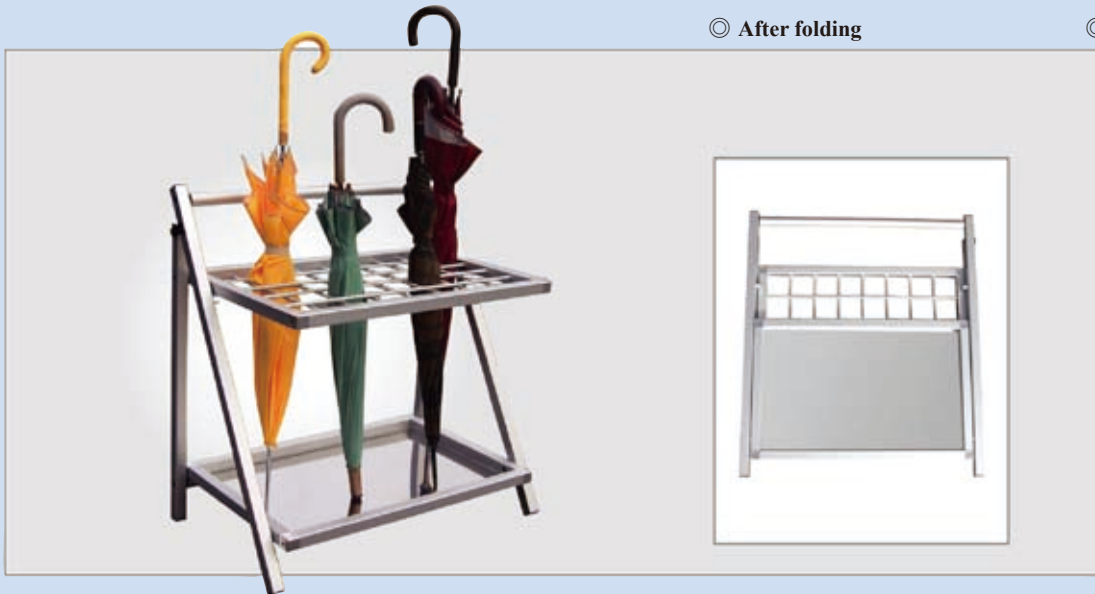

◎ After folding

◎ The method of rack folding

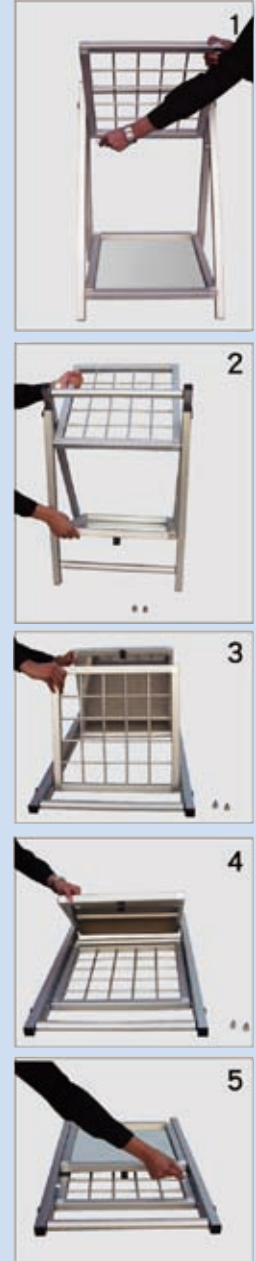

◎ Product Series



# FR-040A	Silver (40 Holes)	# FR-025A	Silver (25 Holes)	# FR-025B	Black (25 Holes)
Material	Aluminum & Stainless Steel	Material	Aluminum & Stainless Steel	Material	Steel with Black Painting
Open Size	W65cm×D39cm×H68cm	Open Size	W45cm×D39cm×H68cm	Open Size	W45cm×D39cm×H68cm
Close Size	W65cm×L76cm×H5.5cm	Close Size	W45cm×L76cm×H5.5cm	Close Size	W45cm×L76cm×H5.5cm

P

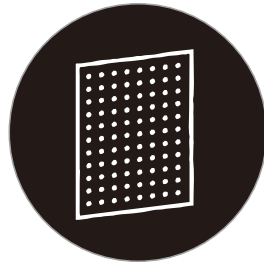

PEGBOARD FIXTURES

CHAPTER	DIVISION	CONTENTS
P	01	PEGBOARD
	02	ACCESSORIES

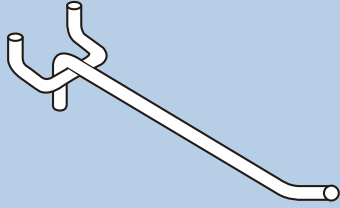

	PEGBOARD HOOK W/STRAIGHT CUT END		
	Light Duty 0.142" dia Wire	Medium Duty 0.187" dia Wire	Heavy Duty 0.225" dia Wire
2"	PBHS-2-LT	PBHS-2-ME	PBHS-2-HD
4"	PBHS-4-LT	PBHS-4-ME	PBHS-4-HD
6"	PBHS-6-LT	PBHS-6-ME	PBHS-6-HD
8"	PBHS-8-LT	PBHS-8-ME	PBHS-8-HD
10"	PBHS-10-LT	PBHS-10-ME	PBHS-10-HD
12"	PBHS-12-LT	PBHS-12-ME	PBHS-12-HD

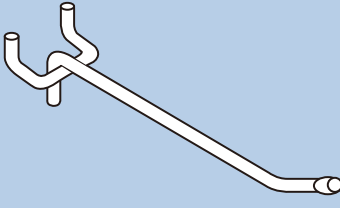
	PEGBOARD HOOK W/BALL TIP END		
	Light Duty 0.142" dia Wire	Medium Duty 0.187" dia Wire	Heavy Duty 0.225" dia Wire
2"	PBHB-2-LT	PBHB-2-ME	---
4"	PBHB-4-LT	PBHB-4-ME	---
6"	PBHB-6-LT	PBHB-6-ME	---
8"	PBHB-8-LT	PBHB-8-ME	---
10"	PBHB-10-LT	PBHB-10-ME	---
12"	PBHB-12-LT	PBHB-12-ME	---

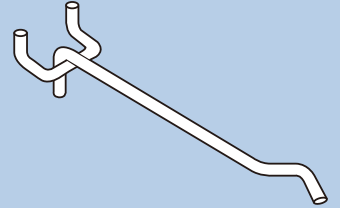
	PEGBOARD HOOK W/DOWNTURNED END		
	Light Duty 0.142" dia Wire	Medium Duty 0.187" dia Wire	Heavy Duty 0.225" dia Wire
2"	PBHD-2-LT	PBHD-2-ME	PBHD-2-HD
4"	PBHD-4-LT	PBHD-4-ME	PBHD-4-HD
6"	PBHD-6-LT	PBHD-6-ME	PBHD-6-HD
8"	PBHD-8-LT	PBHD-8-ME	PBHD-8-HD
10"	PBHD-10-LT	PBHD-10-ME	PBHD-10-HD
12"	PBHD-12-LT	PBHD-12-ME	PBHD-12-HD

Both light duty and medium duty hooks fit 1/8" and 1/4" pegboard

Heavy duty hooks fit only 1/4" pegboard

All pegboard hooks are made with bright zinc finish



PEGBOARD ACCESSORIES

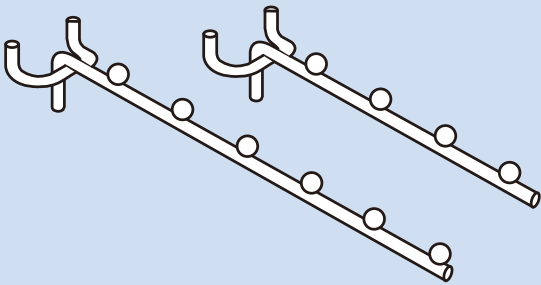

WATERFALL

Fits 1/4" pegboard, chromed

#PB4B 12"L, 4 stops

#PB6B 14"L, 6 stops

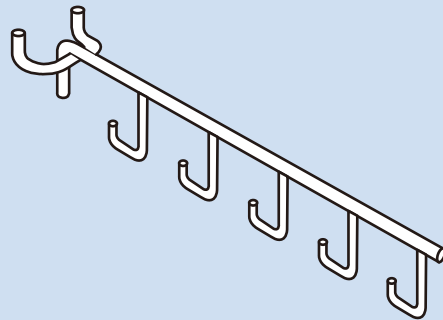

16" LONG WATERFALL

Fits 1/4" pegboard, Use to display handbags, necklaces, umbrellas, mugs, etc.

5 hooks, chromed

PB5H

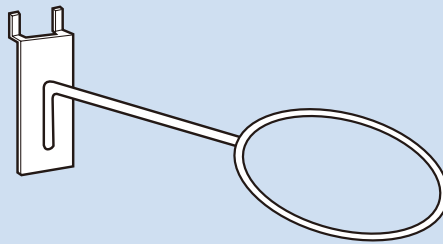

BALL HOLDER

Fits 1/4" pegboard and slatwall.
Galvanized.

PBB2 5 1/4" dia., 10"L

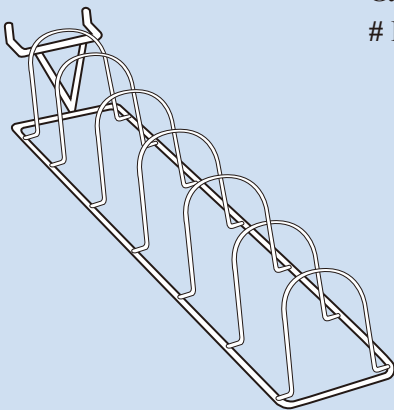

CLUTCH PURSE DISPLAYER

Downslant with 6 compartments.
18"L, each compartment is 3" wide.
Fits 1/4" pegboard and slatwall.
chromed wire.

SW-CL

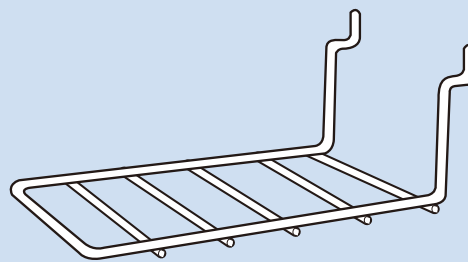

EARRING LADDER DISPLAYER

6 rungs spaced 7/8" apart.
4 1/2"L x 3" W, chromed
Fits 1/4" pegboard and slatwall.

ELD

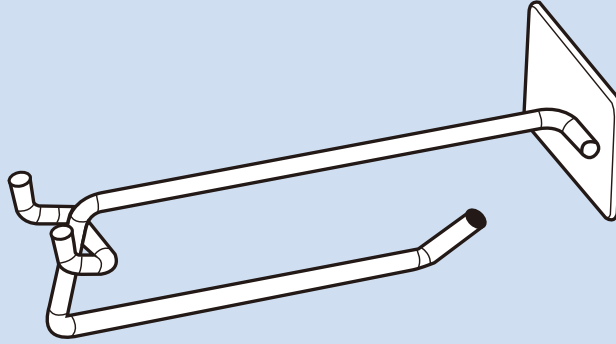

PEGBOARD SCANNER HOOK ZINC

Length	Metal Plate: 1-3/8"×3"×1.5mm Wire Dia. 0.187"	Metal Plate: 1-3/8"×3"×1.5mm Wire Dia. 0.225"	Metal Plate: 1-3/8"×2-1/8"×1.5mm Wire Dia. 0.187"	Metal Plate: 1-3/8"×2-1/8"×1.5mm Wire Dia. 0.225"
4"	M13P4-ME	M13P4-HD	M12P4-ME	M12P4-HD
6"	M13P6-ME	M13P6-HD	M12P6-ME	M12P6-HD
8"	M13P8-ME	M13P8-HD	M12P8-ME	M12P8-HD
10"	M13P10-ME	M13P10-HD	M12P10-ME	M12P10-HD
12"	M13P12-ME	M13P12-HD	M12P12-ME	M12P12-HD

PEGBOARD SCANNER HOOK CHROME

Length	Metal Plate: 1-3/8"×3"×1.5mm Wire Dia. 0.187"	Metal Plate: 1-3/8"×3"×1.5mm Wire Dia. 0.225"	Metal Plate: 1-3/8"×2-1/8"×1.5mm Wire Dia. 0.187"	Metal Plate: 1-3/8"×2-1/8"×1.5mm Wire Dia. 0.225"
4"	M13P4-ME-C	M13P4-HD-C	M12P4-ME-C	M12P4-HD-C
6"	M13P6-ME-C	M13P6-HD-C	M12P6-ME-C	M12P6-HD-C
8"	M13P8-ME-C	M13P8-HD-C	M12P8-ME-C	M12P8-HD-C
10"	M13P10-ME-C	M13P10-HD-C	M12P10-ME-C	M12P10-HD-C
12"	M13P12-ME-C	M13P12-HD-C	M12P12-ME-C	M12P12-HD-C

R

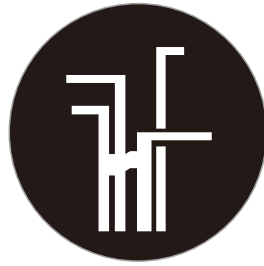

RACKS

CHAPTER	DIVISION	CONTENTS
R	01	ACCESSORIES
	02	ARM, HANGRAIL, ETC. - COMPONENTS
	03	BAGGING DISPENSER
	04	BELT, TIE & SOCK
	05	BLACK BEAUTY
	06	BRASS PLATED
	07	EPOXY COATED
	08	GARMENT
	09	HANDBAG
	10	HAT
	11	JEWELRY
	12	LINGERIE
	13	SALESMAN
	14	SHOE
	15	SHOWROOM
	16	STOCKROOM
	17	T AND L FRAMES
	18	TOPPERS
	19	OTHER RACKS
	20	SPINNERS
	21	SATIN FINISH

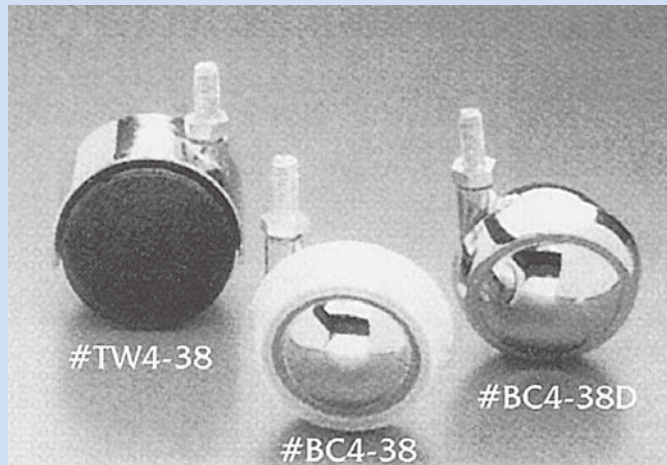

**CASTERS $\frac{3}{8}$ "-16UNC THREAD \times $\frac{3}{4}$ " LONG STEM
5/16" STEMMED CASTERS AVAILABLE**

TWIN NYLON WHEELS-CHROME HOOD

- # TW4-38 2½" dia. zinc casting hood
- # TW4-38L 2½" dia. zinc casting hood
2 locking, 2 non-locking
- # TW4-38P 2" dia. plastic hood
- # TW4-38PL 2" dia. plastic hood
2 locking, 2 non-locking
- # TW4-38PBL Same as TW4-38PL,
but with black hood.

DELUXE 2½" ROLLING BALL

Bright chrome with removable plastic rim.
For hard or carpeted floors.

BC4-38

All chrome. For heavy duty use.

BC4-38D

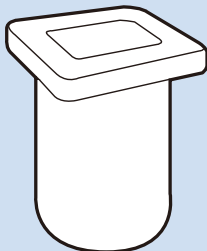

PLASTIC SWEDGE CAPS

In clear color

PSC

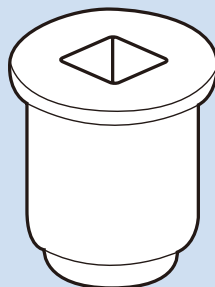

**ZINC DIE CAST
ROUND TOP FITTINGS**

RTF

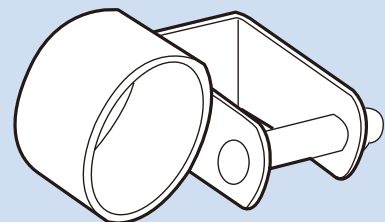

**ADD-ON HANGRAIL
ADAPTER, CHROME**

CLH2A-C

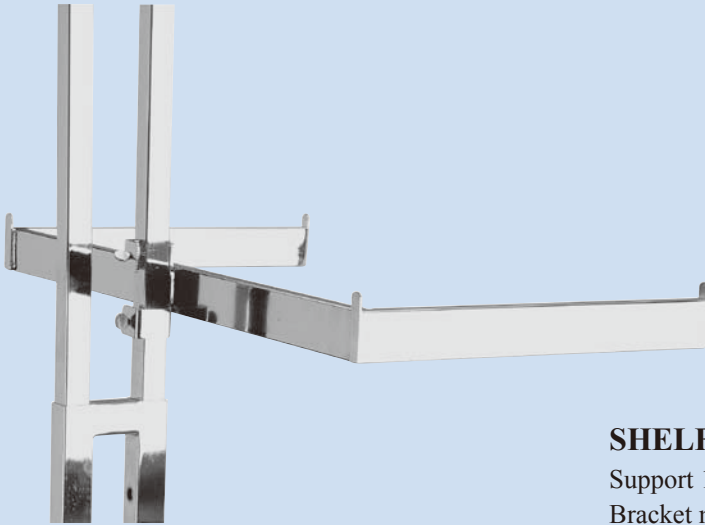

SHELF BRACKET FOR 4-ARM RACK

Support 13"x 24" shelf
Bracket made of 1/2" x 1-1/2"
rectangular tubing, with a clamp
attached to a 1" square tubing
upright, Tightening screws included.

TV24

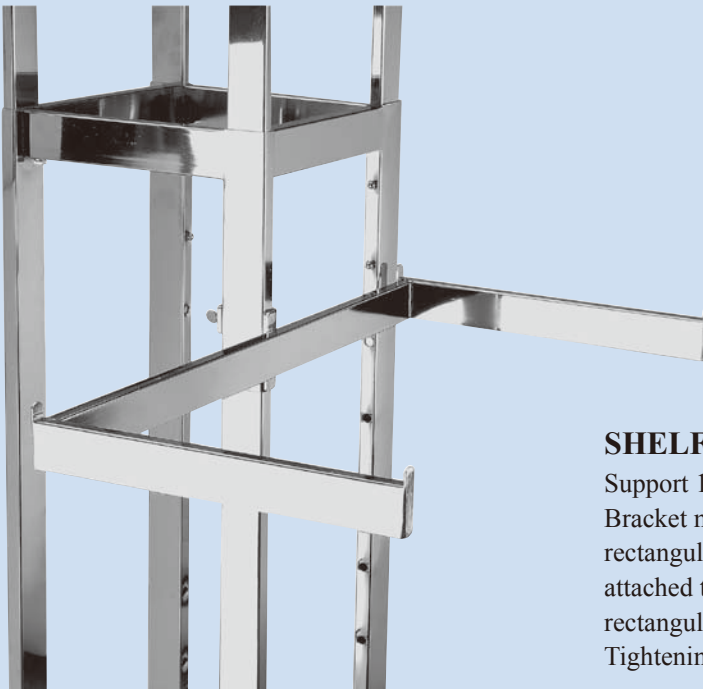

SHELF BRACKET FOR 4-ARM RACK

Support 13"x 24" shelf
Bracket made of 1/2" x 1-1/2"
rectangular tubing, with a clamp
attached to a 5/8" x 1-5/8"
rectangular tubing upright,
Tightening screws included.

RV24



Three Roll Poly Dispensing Rack

Made of 1" square tubing. Bagging jack adjusts from 39" to 68". Floor space require 18" x 30" Total height 74"

RK30



One Roll Poly Dispensing Rack

Base made of 1" square tubing, Holds 1 roll of poly on ball bearing mounted platform for ease of turning. Bagging jack adjusts from 39" to 68". Floor space required 13" x 18".

RK31



Bagging Jack

Vertical jack adjusts from 39" to 68", Heavyweight base is 12" diameter.

RK32

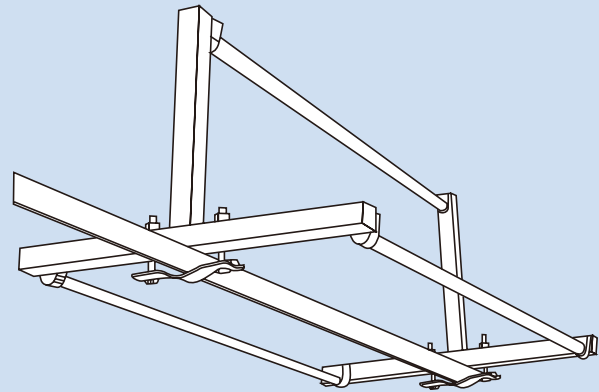

Three Roll Overhead Poly Dispensing Rack

Made of 1" square tubing. Sturdy clamp construction for positive mounting to round rail or pipe.

RK33

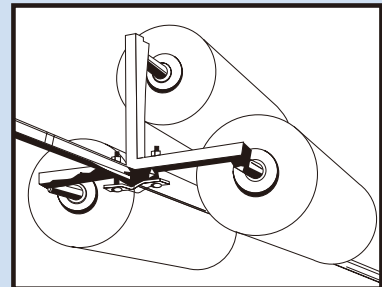

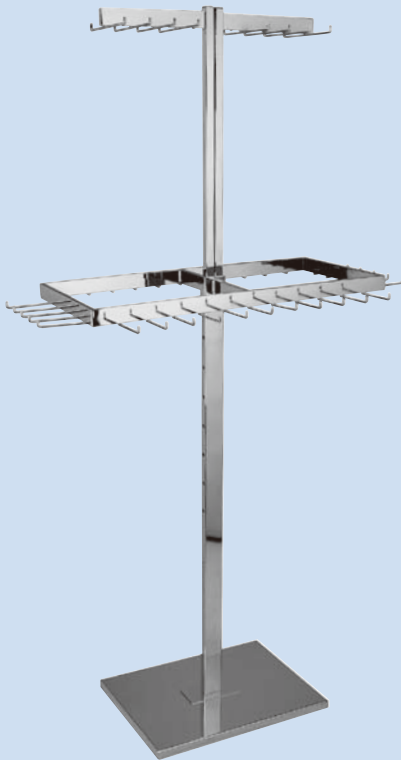

BELT & TIE RACK

- Made of all rectangular tubing
 - Top tier has 16-4" hooks and is adjustable from 51" to 72" in height
 - Bottom tier has 32-4" hooks and stands 45" high
 - 1" x 2" Upright
 - 15" X 20" Heavy weighted base
 - Chrome finish
- # RB48

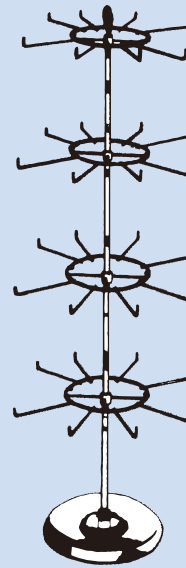

4 TIER REVOLVING HOSIERY RACK

- 4 23-1/2" dia. revolving tiers
 - Each tier has 8 7-1/2" hooks
 - 67" high
 - 18" dia. base
 - Chrome finish
- # 180-4E3

DELUXE BELT & TIE RACK

- Heavy duty 1" x 2" rect tubing
- 48 4" hooks
- Lower tier 45" high
- Unit stands 56" high
- Base 31" L x 18" W
- Chrome finish

RB56

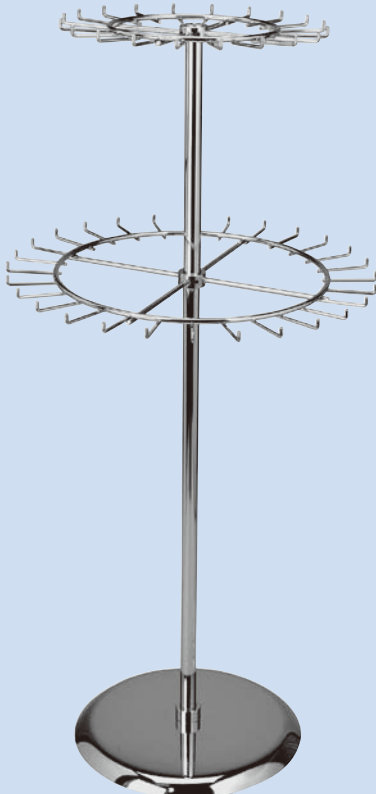
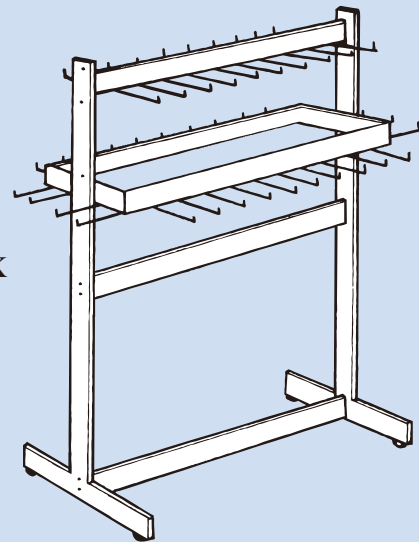

2 TIER REVOLVING BELT & TIE RACK

- Smoothly revolves on 2 levels for easy shopping
- Upper ring 19" dia. with 20 pcs of 3" L. hooks
- Lower ring 27" dia. with 28 pcs of 3" L. hooks
- Upright made of 1-1/4" dia. tubing, stands a full 60" H.
- 18" dia. base
- Chrome finish

RK56

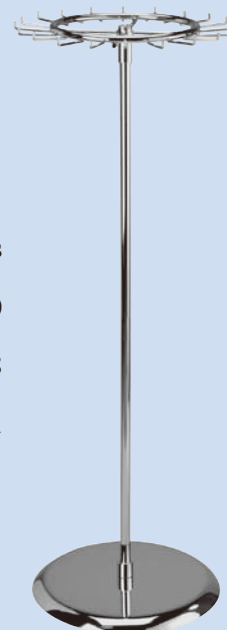

REVOLVING BELT RACK

- 20 3" hooks on 19" dia. ring
- 52" high
- 18" dia. base
- Chrome finish

RK58

BLACK BEAUTY RACKS



Sturdily constructed of 1" black baked enamel tubing & Chrome Hangrails.

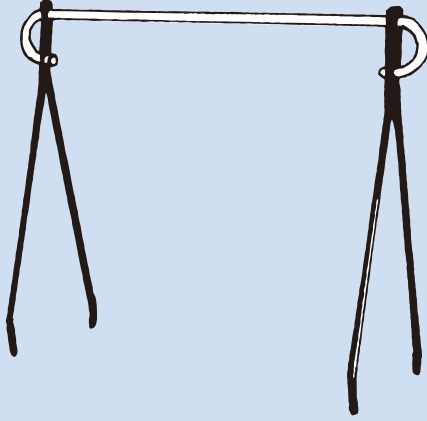

SINGLE BAR RACKS

- # SB485 48"H x 60"L
- # SB545 54"H x 60"L
- # SB645 64"H x 60"L



DOUBLE BAR RACKS

- # DB485 48"H x 60"L
- # DB545 54"H x 60"L
- # DB645 64"H x 60"L

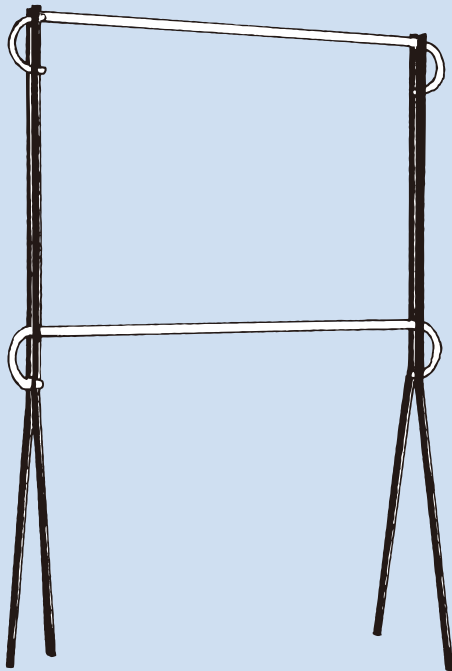

TWO TIER SINGLE RACK

A Space Saver 76" H X 60" L
 Height to top of lower hangrail 45"
 to top of upper hangrail 76"
 # SB2T

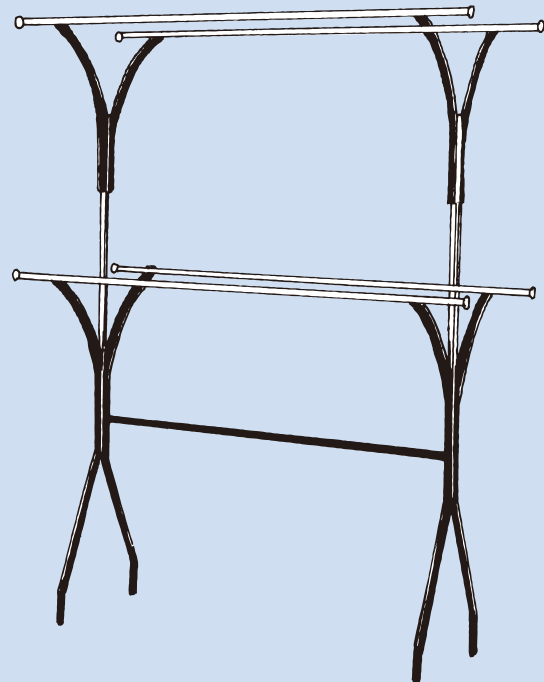

TWO TIER DOUBLE RACK

20 Feet of Hanging Space! The
 upper hangrails are adjustable 72"
 or 76" high. Lower hangrails are 44"
 from floor. 60" long.
 # DB2T

EPOXY COATED RACKS-BLACK OR WHITE



Other Colors Available!

- Custom look at affordable price.
- Rack frame are 1" square tubing finished in durable Black or White Epoxy.
- Arms are polished chrome 1½" × ½" rectangular tubing.

A word about our Black or White finish. This is a special process powder coated epoxy finish. It is extremely hard, durable, and scratch resistant.

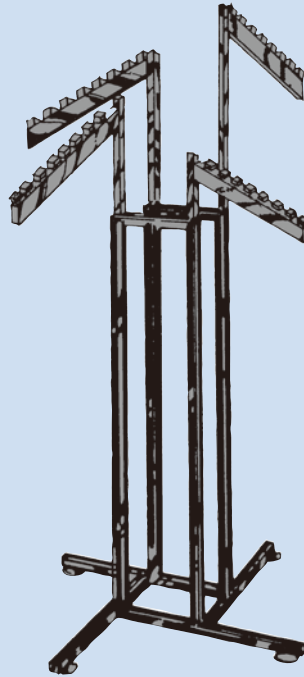

Rectangular Slant Arms

4-8 cube, 16" Chrome arms
 # MQ84SBLACK
 # MQ84SWHITE



Rectangular Straight Arms

4-16" Chrome Arms
 # MQ84CBLACK
 # MQ84CWHITE



Round Rack With Rectangular Rail

36" Dia. Chrome Rail
 # RR36-BLACK
 # RR36-WHITE

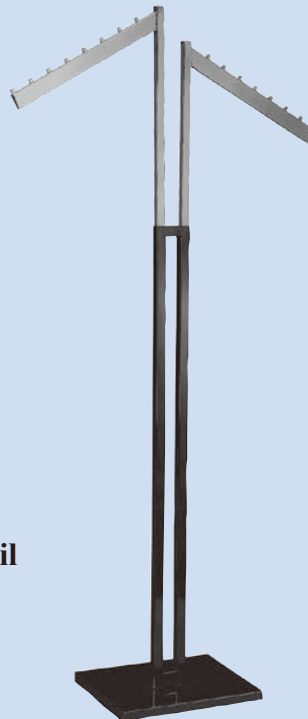

Rectangular Slant Arms

2-8 Cube, 16" Chrome Arms
 # R80-2BLACK
 # R80-2WHITE

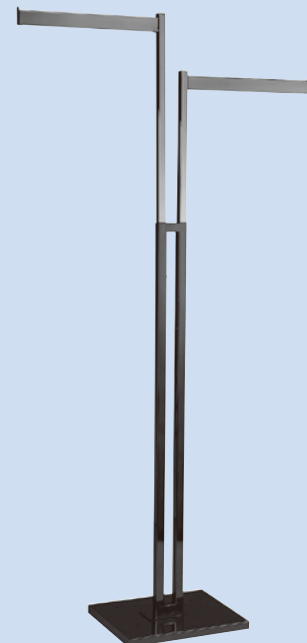

Rectangular Straight Arms

2-16" Chrome Arms
 # R80-1BLACK
 # R80-1WHITE



FRAMES



4 Way Frames
MQB-BLACK
MQB-WHITE

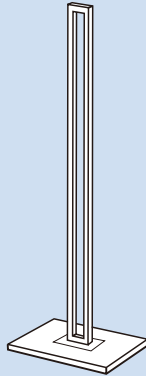

2 Way Frames
R70B-BLACK
R70B-WHITE



Round Folding Rack Frames
RR36B-BLK 36" Dia.
RR36B-WHT 36" Dia.
RR42B-BLK 42" Dia.
RR42B-WHT 42" Dia.

ARMS

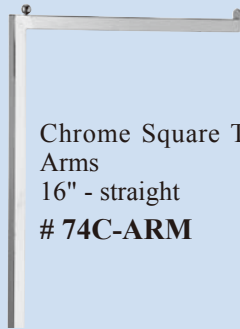

Chrome Square Tubing
Arms
16" - straight
74C-ARM

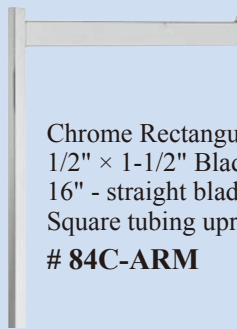

Chrome Rectangular Tubing
1/2" x 1-1/2" Blade Arms
16" - straight blade
Square tubing upright
84C-ARM

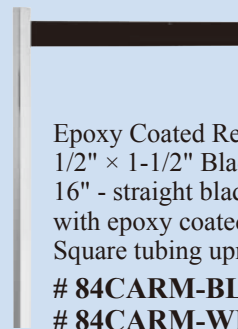

Epoxy Coated Rectangular Tubing
1/2" x 1-1/2" Blade Arms
16" - straight blade
with epoxy coated sleeve
Square tubing upright
84CARM-BLK
84CARM-WHT

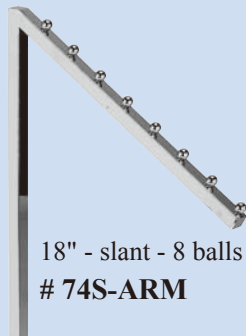

18" - slant - 8 balls
74S-ARM

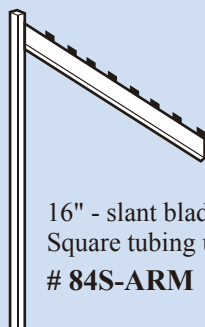

16" - slant blade - 8 cubes
Square tubing upright
84S-ARM

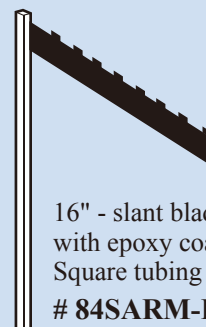

16" - slant blade - 8 cubes
with epoxy coated sleeve
Square tubing upright
84SARM-BLK
84SARM-WHT

HANGRAILS

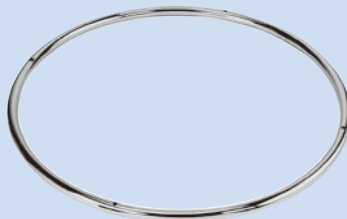

Round Tubing 1-1/4"
Chrome plated
CR36-RING 36" Dia.
CR42-RING 42" Dia.

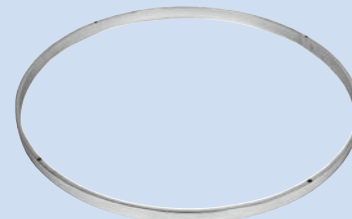

Rectangular Tubing
1/2" x 1-1/2" Chrome Plated
RR36-RING 36" Dia.
RR42-RING 42" Dia.

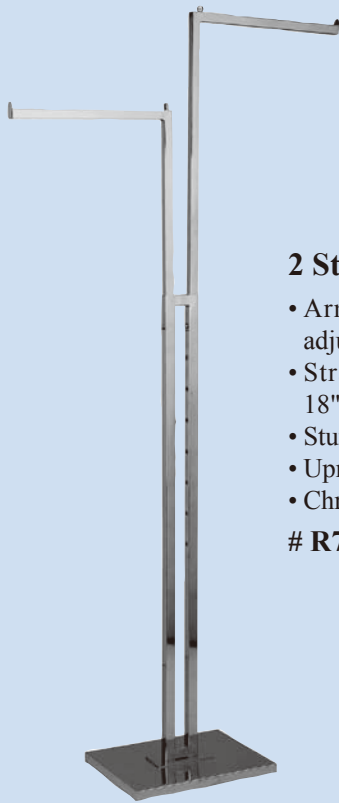

2 Straight Arm

- Arms made of .830" sq. tubing, adjust from 48" to 72" every 3"
- Straight arms 16"L, Slant arms 18"L with 8 ball stops
- Sturdy 12"×15" weighted base
- Upright made of twin 1" sq. tubing
- Chrome finish

R70-1



2 Slant Arm

R70-2



1 Straight, 1 Slant

R70-3



2 Straight Arm

- Same as #R70 racks, but arms made of 1/2"×1 1/2" rect tubing.
- Straight arms 16"L, Slant arms 16"L with 8 cube stops.

R80-1



2 Slant Arm

R80-2

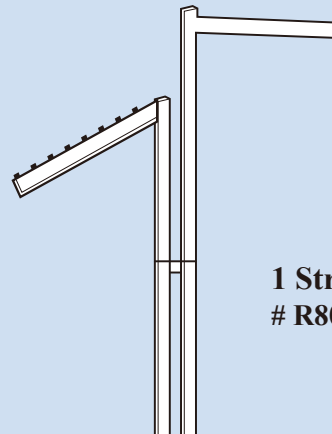

1 Straight, 1 Slant

R80-3



GARMENT RACKS

2 ARM RACKS • SINGLE UPRIGHT

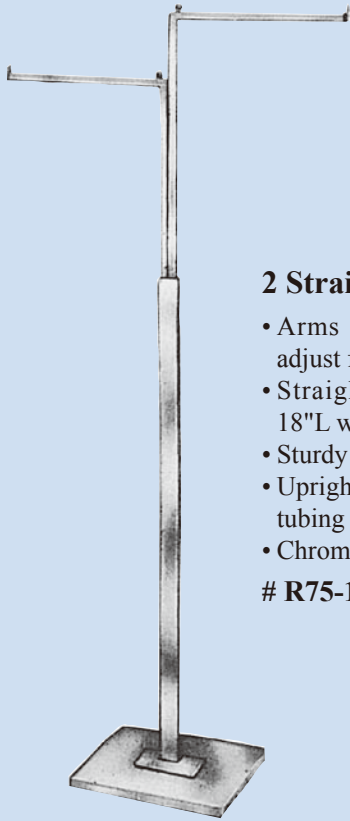

2 Straight Arm

- Arms made of .830" sq. tubing, adjust from 48" to 72" every 3"
- Straight arms 16"L, Slant arms 18"L with 8 ball stops.
- Sturdy 12"×15" weighted base
- Upright made of single 1"×2" rect tubing
- Chrome finish

R75-1

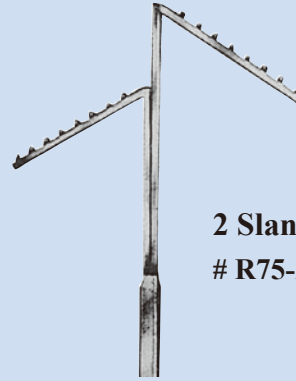

2 Slant Arm

R75-2

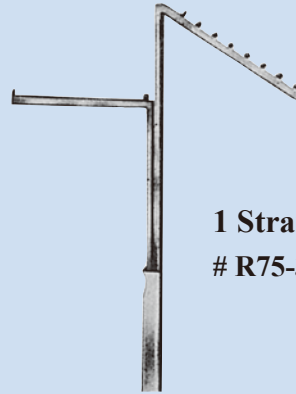

1 Straight, 1 Slant

R75-3

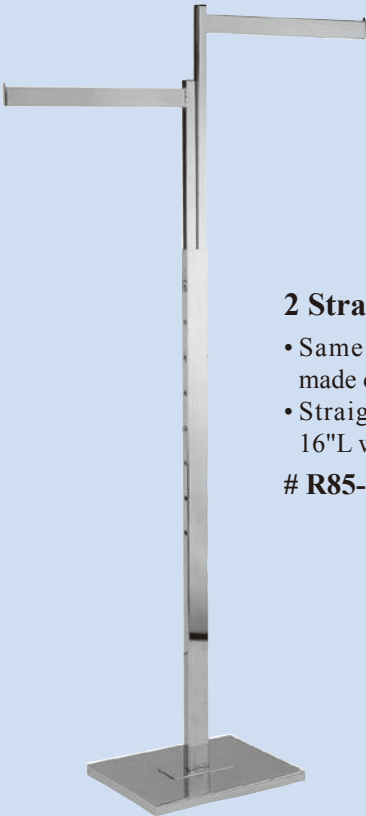

2 Straight Arm

- Same as #R75 racks, but arms made of ½"×1½" rect tubing.
- Straight arms 16"L, Slant arms 16"L with 8 cube stops.

R85-1



2 Slant Arm

R85-2

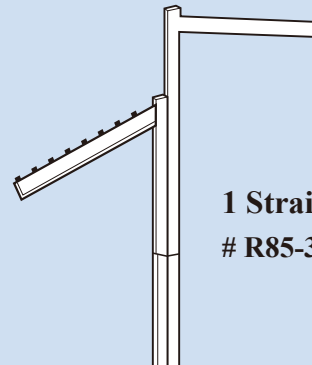

1 Straight, 1 Slant

R85-3

GARMENT RACKS

BOW ARM RACKS + DEWXE 2 ARM RACKS

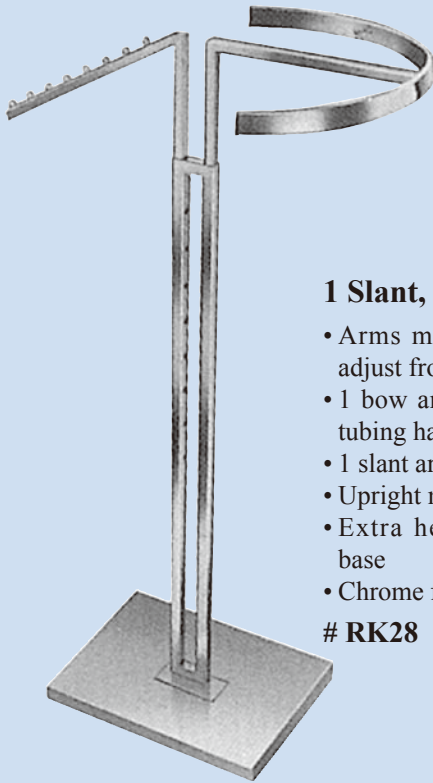

1 Slant, 1 Bow Arm

- Arms made of .830" sq. tubing, adjust from 48" to 72" every 3"
- 1 bow arm with 1/2"×1-1/2" rect. tubing hangrail
- 1 slant arm 18" with 8 ball stops
- Upright made of 1" sq. tubing
- Extra heavy 15"×20" weighted base
- Chrome finish

RK28

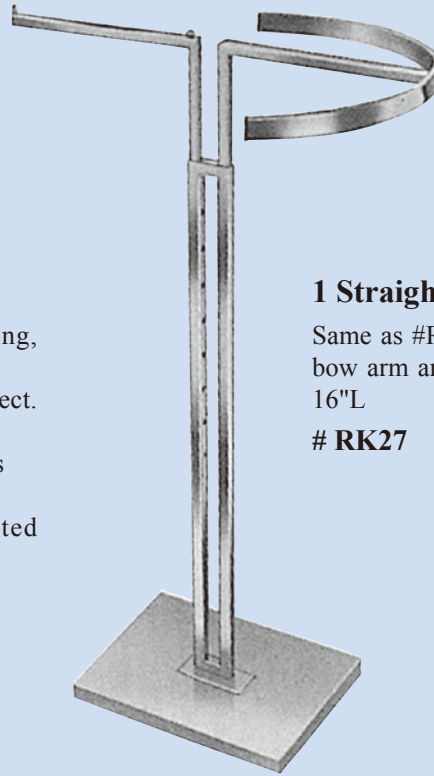

1 Straight, 1 Bow Arm

Same as #RK28, but with 1 bow arm and 1 straight arm 16"L

RK27

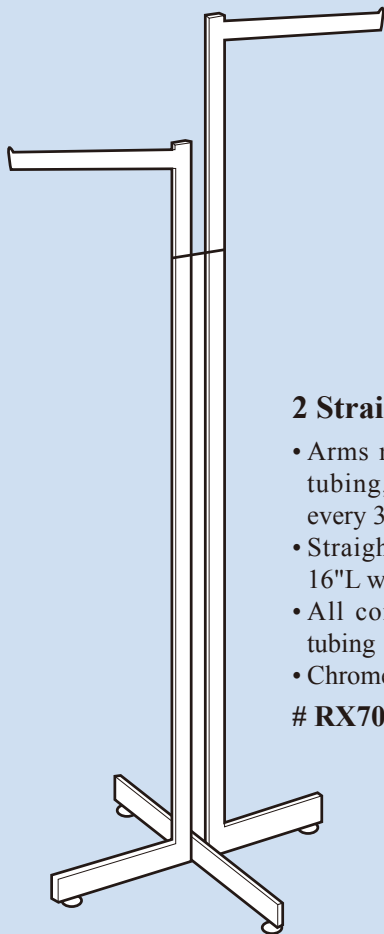

2 Straight Arm

- Arms made of 1/2"×1-1/2" rect tubing, adjust from 48" to 72" every 3"
- Straight arms 16"L, Slant arms 16"L with 8 cubes
- All constructed of rectangular tubing
- Chrome finish

RX70-1

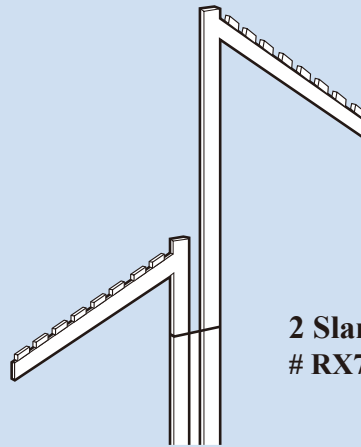

2 Slant Arm

RX70-2

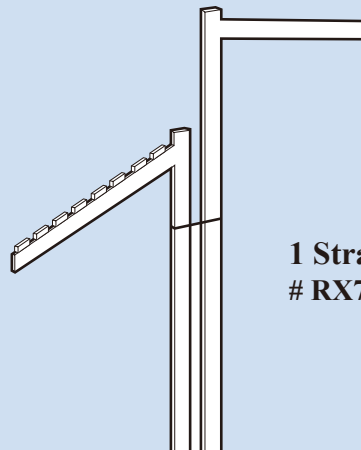

1 Straight, 1 Slant

RX70-3



GARMENT RACKS

3 ARM RACKS

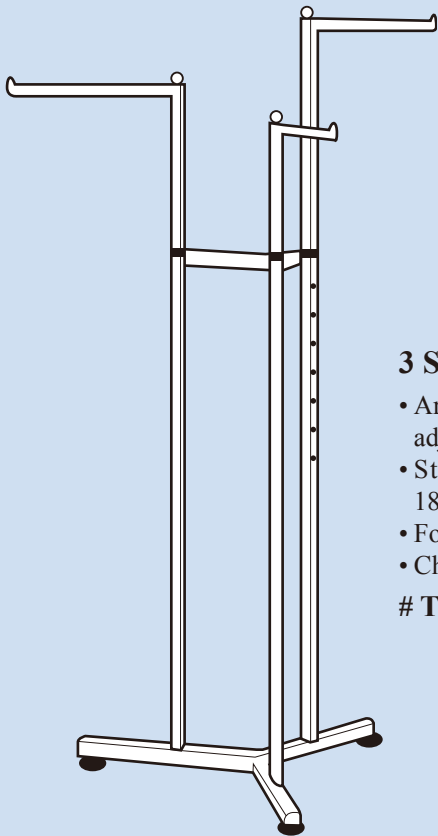

3 Straight Arm

- Arms made of .830" tubing, adjust 48" to 72" every 3"
- Straight arms 16"L, Slant arms 18"L with 8 ball stops
- Folds flat for easy storage
- Chrome finish

TR74C

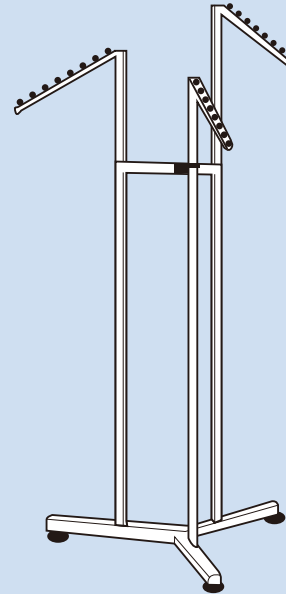

3 Slant Arm

TR74S

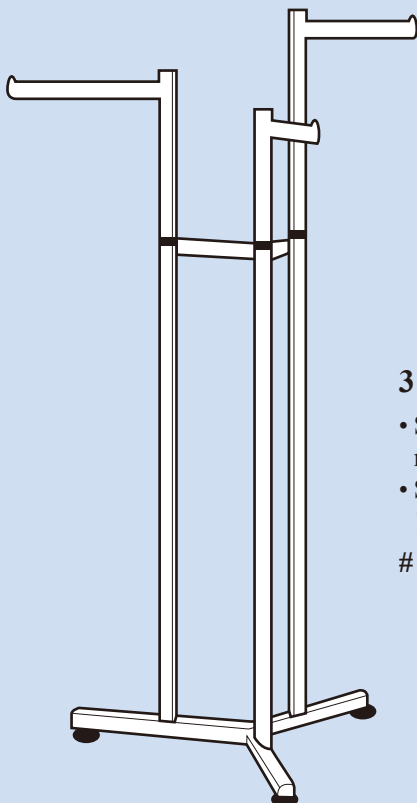

3 Straight Arm

- Same as #TR74 racks, but arms made of 1/2"x1/2" rect tubing.
- Straight arms 16"L, Slant arms 16"L with 8 cube stops.

TR84C

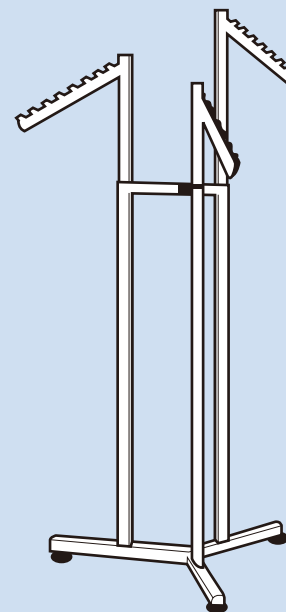

3 Slant Arm

TR84S



- Arms made of 1/2"×1 1/2" rect tubing, adjust form 48" to 72" every 3"
- Tee arm 22 1/2", Straight arm 16"L, Slant arm 16"L with 7 cube stops, each arm has 10" spacer from upright
- Upright made of 1"×3" rect tubing
- 15"×15" heavy base
- Chrome finish

1 Tee Arm, 2 Slant "Z" Arms
RK3X

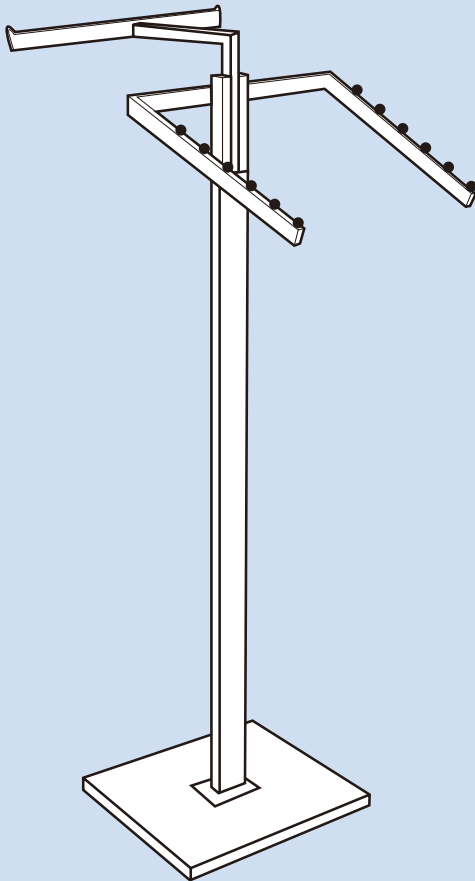

1 Tee Arm, 2 Straight "Z" Arms
RK3C

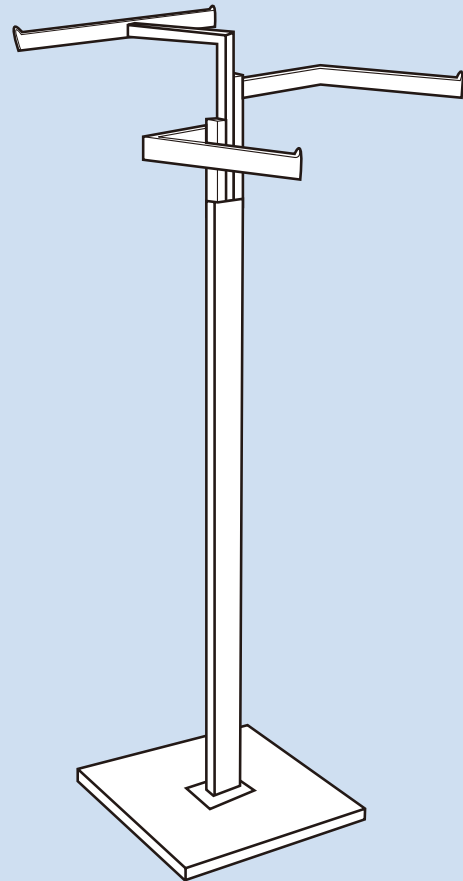



GARMENT RACKS

4 ARM RACKS



4 Straight Arm

- Arms made of .830" sq. tubing adjust from 48" to 72" every 3"
- Straight arms 16"L, Slant arms 18"L with 8 ball stops
- Base made of 1" sq. tubing
- Chrome finish

MQ74C



4 Slant Arm

MQ74S



2 Straight, 2 Slant

MQ74X

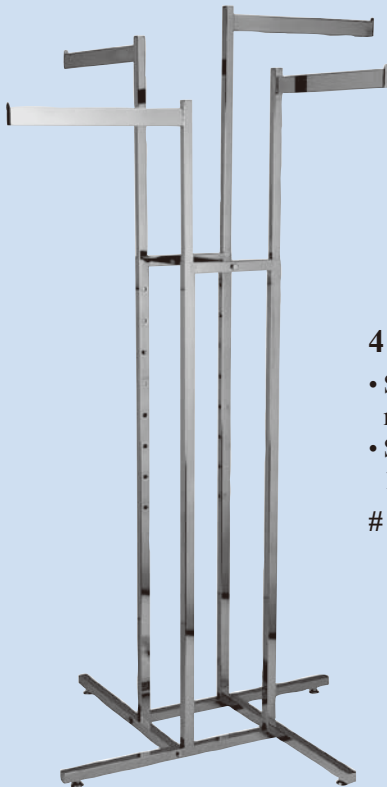

4 Straight Arm

- Same as #MQ74 Racks but Arms made of 1/2" x 1/2" rect tubing.
- Straight arms 16"L, Slant arms 16"L with 8 cube stops.

MQ84C

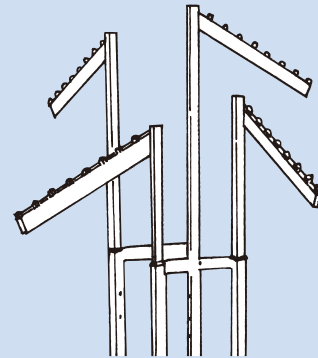

4 Slant Arm

MQ84S

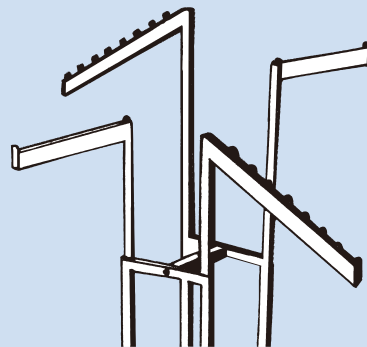

2 Straight, 2 Slant

MQ84X

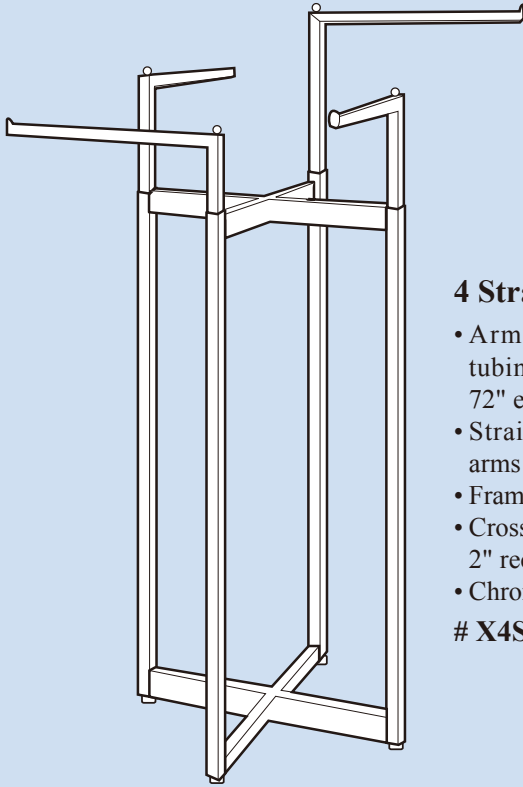

4 Straight Arm

- Arms made of .830" sq. tubing, adjust from 48" to 72" every 3"
 - Straight arms 16"L, Slant arms 18"L with 8 ball stops
 - Frame made of 1" sq. tubing
 - Crossbar is 22" made of 1"×2" rect. tubing
 - Chrome finish
- # X4SQ-74C

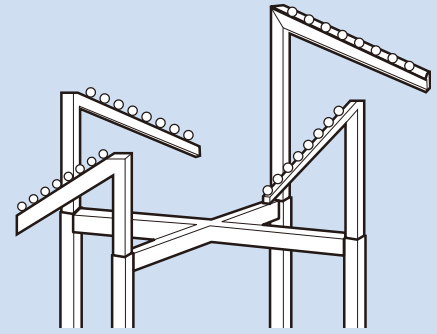

4 Slant Arm
X4SQ-74S

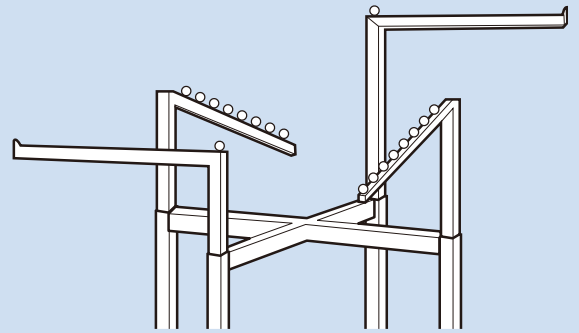

2 Straight, 2 Slant
X4SQ-74X

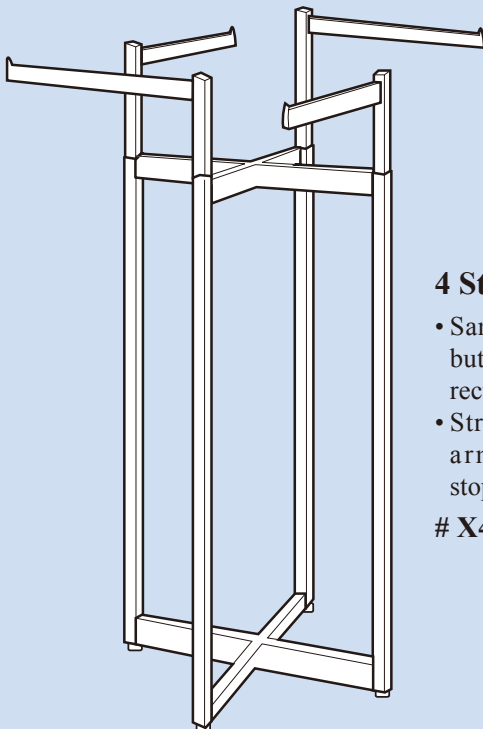

4 Straight Arm

- Same as #X4SQ-74 Racks but Arms made of 1/2"×1 1/2" rect. tubing.
 - Straight arms 16"L, Slant arms 16"L with 8 cube stops.
- # X4SQ-84C

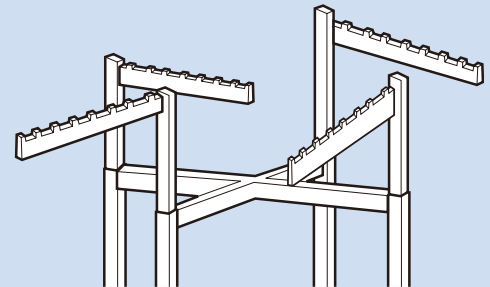

4 Slant Arm
X4SQ-84S

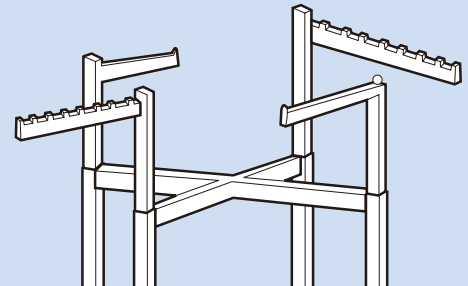

2 Straight, 2 Slant
X4SQ-84X



GARMENT RACKS

4 STEP ARM RACKS + PANEL RACK

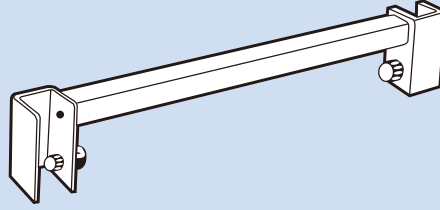

HVF2B - Optional Hangbar for HVF2
HVF6B - Optional Hangbar for HVF6

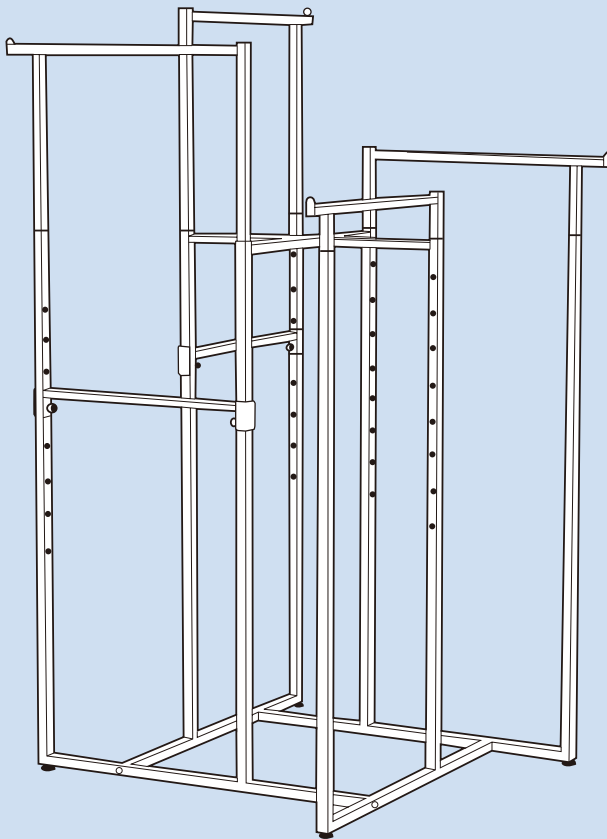

Four Panel Rack

- Adjusts from 48" to 72" every 3"
- Arms made of .830" sq. tubing
- Chrome finish

HVF2 - 22" Arms
HVF6 - 26" Arms

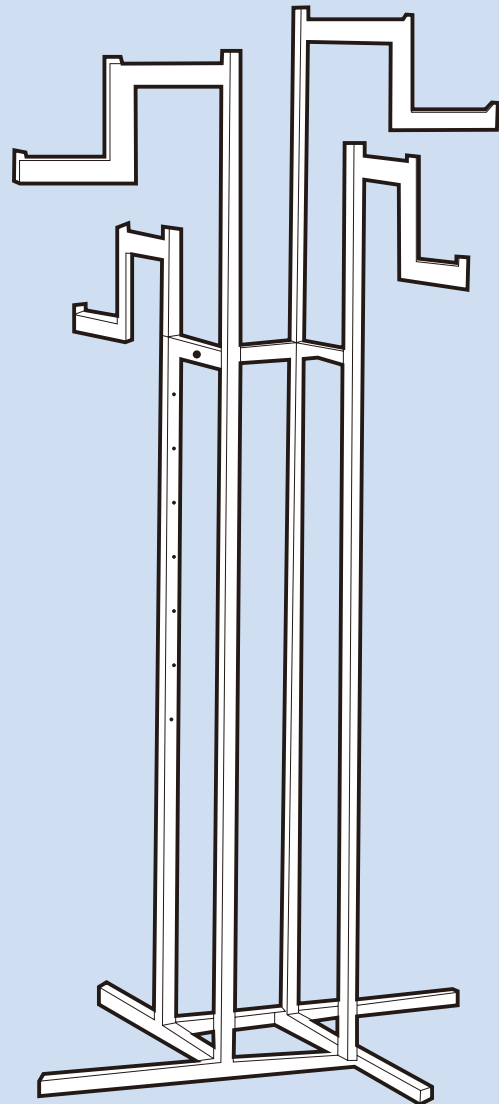

4 Split Level Straight Arm

- Same as #MQ74 racks, but arms made of 1/2"x1 1/2" rect. tubing.
- Each split level straight arm is 14" long with 6" drop.

MQ84Z

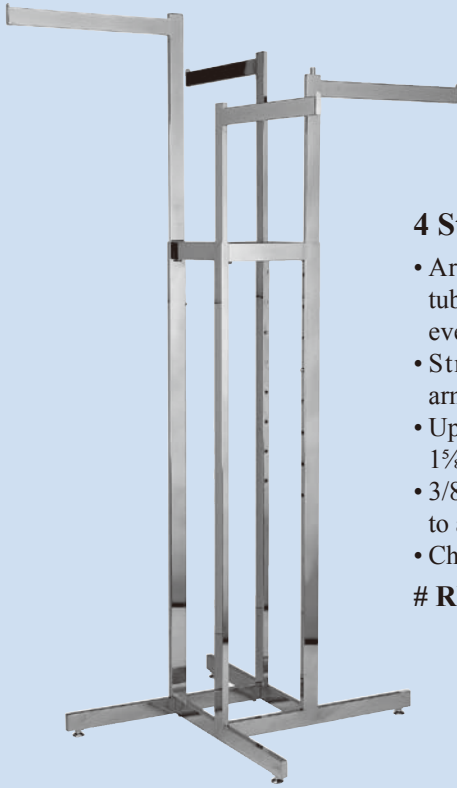

4 Straight Arm

- Arms made of 1/2"×1 1/2" rect. tubing, adjust from 48" to 72" every 3"
- Straight arms 16"L, Slant arms 16"L with 8 cube stops
- Uprights of base made of 5/8"×1 5/8" rect. tubing
- 3/8" threaded fitting on 1 arm to accept card frame
- Chrome finish

RR74C

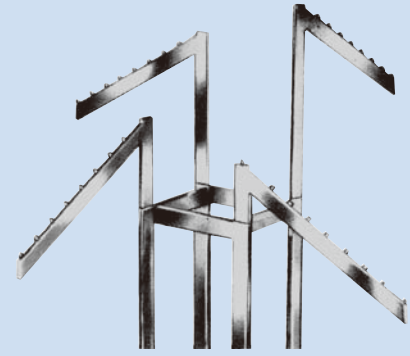

4 Slant Arm
 # RR74S

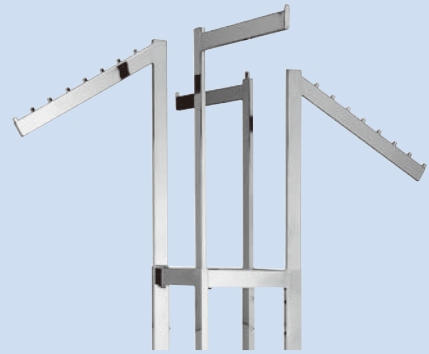

2 Straight, 2 Slant
 # RR74X



4 Straight Arms

- Straight arms 22"L, made of 1/2"×1-1/2" rect. tubing
- Slant arms 22" with 11 cube stops
- Arms adjust from 48" to 72" every 3"
- Base made of 5/8"×1-5/8" rect. tubing
- 3/8" threaded fitting on 1 arm to accept card frame
- Chrome finish

RR22C

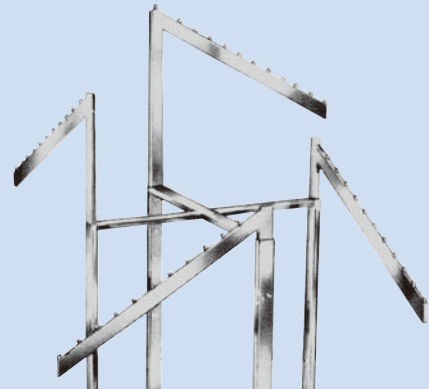

4 Slant Arms
 # RR22S



2 Straight, 2 Slant
 # RR22X



GARMENT RACKS

FOLDING + TELESCOPING 4 ARM RACKS

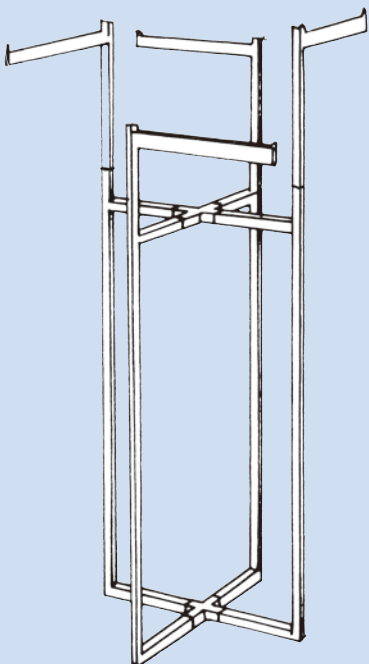

4 Straight Arm

- Arms made of 1/2" x 1 1/2" rect. tubing, adjust from 48" to 72" every 3"
- Straight arms 16"L, Slant arms 16"L with 8 cube stops
- 1" sq. tubing uprights & 1" x 2" crossbars
- Chrome finish
- Space saving and folds flat for easy storage.

FQ84C

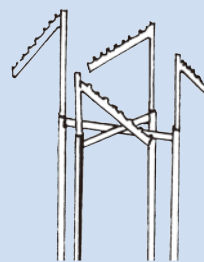

4 Slant Arm # FQ84S

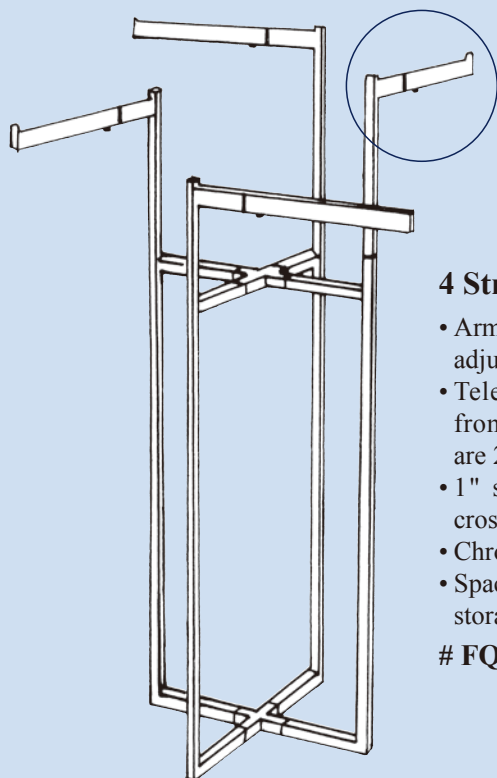
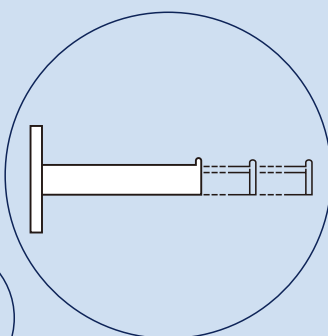
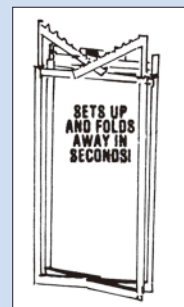

4 Straight Telescoping Arm

- Arms made of 1/2" x 1 1/2" rect. tubing, adjust from 48" to 72" every 3"
- Telescoping straight arms expand from 16" to 19" or 22", Slant arm are 22" with 11 cube stops
- 1" sq. tubing uprights & 1" x 2" crossbars
- Chrome finish
- Space saving and folds flat for easy storage.

FQ94C

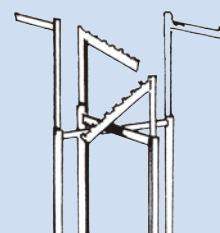

2 Straight, 2 Slant # FQ84X

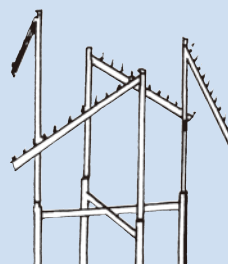

4 Slant Arm # FQ94S

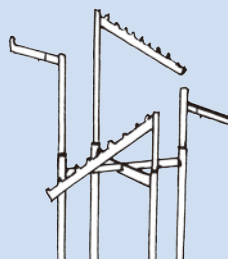

2 Straight Telescoping 2 Slant # FQ94X

GARMENT RACKS

ADJUSTABLE ROUND RACKS

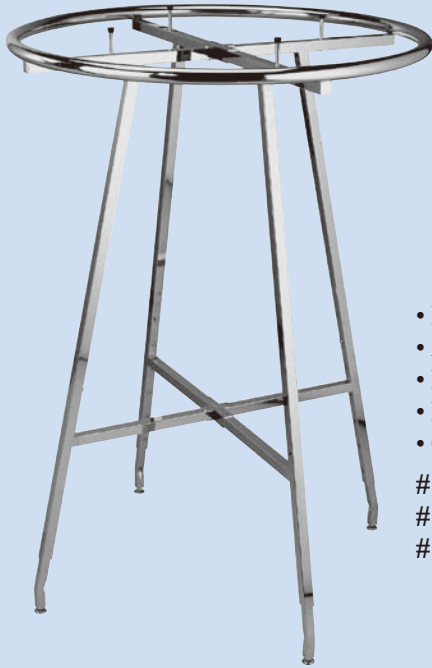

- Hangrail made of 1-1/4" round tubing
- Adjusts from 48" to 66" every 3"
- Base made of 1" sq. tubing
- Folds flat for easy storage
- Chrome finish

CR30 30" Dia.
 # **CR36** 36" Dia.
 # **CR42** 42" Dia.



Same as #CR racks but with
 1/2" x 1-1/2" rect tubing hangrail

RR30 30" Dia.
 # **RR36** 36" Dia.
 # **RR42** 42" Dia.



ADD-A-RING

Adjusts to any height for double hanging. Include Adj. clamps

1-1/4" Round Tubing

AO30 30" Dia.
 # **AO36** 36" Dia.
 # **AO42** 42" Dia.

1/2 x 1-1/2" Rect. Tubing

AR30 30" Dia.
 # **AR36** 36" Dia.
 # **AR42** 42" Dia.

Adjustable clamps

for holding add-on hangrails,
 chromed, 4 pcs per set.
 # **AO36B**

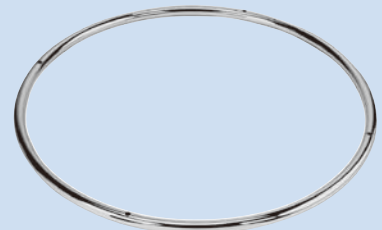

Round Tubing 1-1/4"
 chrome plated

CR30-Ring 30" Dia.
 # **CR36-Ring** 36" Dia.
 # **CR42-Ring** 42" Dia.

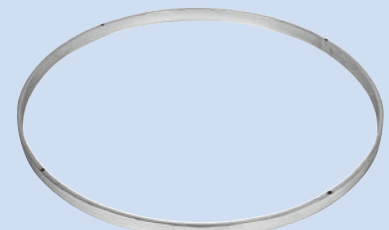

➤ Rectangular Tubing
 1/2" x 1-1/2"
 chrome plated

RR30-Ring 30" Dia.
 # **RR36-Ring** 36" Dia.
 # **RR42-Ring** 42" Dia.



GARMENT RACKS

TOPPER FOR ROUND RACKS

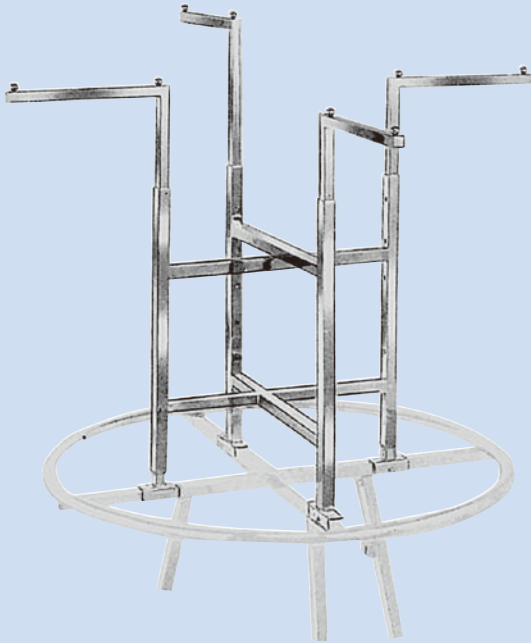

Adjustable 4-Arm Rack Topper

- Arms 12" L
- Adjusts from 28" to 40" every 3"
- Chrome finish

RK59

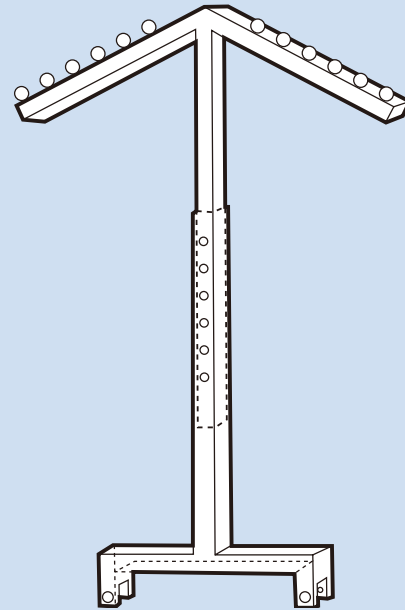

Waterfall Topper For Round Rack

- Arms 12" L
- Adjusts from 27" to 42" every 3"
- 10"L base mounted on top of round rack
- Chrome finish

CRWT

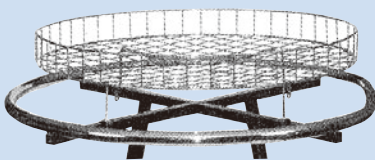

Grid Rack Topper For Round Rack

- 30" Dia Grid Rack Topper has 3" lip all around. Adjustable legs accommodate any size circular rack.
- Maximizes existing selling space. Dust Free. Easy Installation. Ideal for accessories and related items.
- Chrome finish

CR-TP



ROUND SHELF TOPPER:

TOP \ DIA	30"	36"
BD	BD36	BD42
TG	TG36	TG42
GD	GD36	GD42
TO FIT ON	36" Round Rack	42" Round Rack

BD = Black Disc top is made of hard plastic 3/8" thick, looks like a matte black wood.

TG = Tempered Glass top 3/16" thick.

GD = Green Disc top is made of green acrylic 3/8" thick with rounded edges, looks like glass, but stronger and safer.

GARMENT RACKS

TRI-LEVEL ROUND RACKS

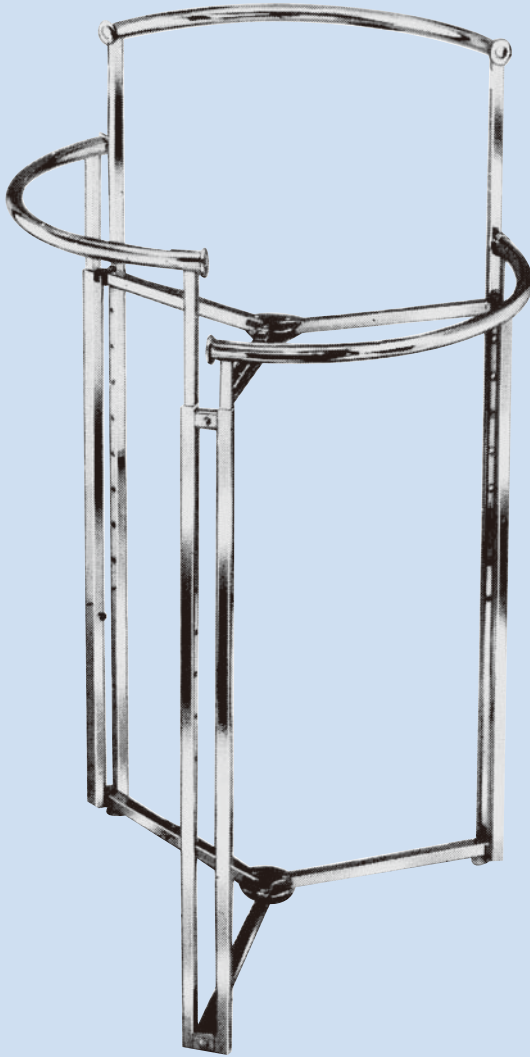

- 3 curved hangrails, 1-1/4" round and each is individually adjustable
- Adjusts from 48" to 72" every 3"
- Folds flat for easy storage
- Chrome finish

TL36 36" dia.
TL42 42" dia.

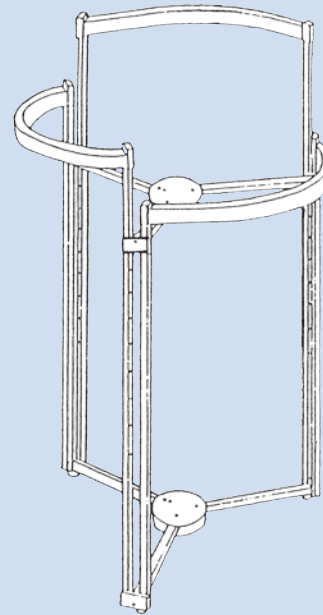

Same as #TL36, but with 1/2" x 1-1/2" rect. tubing hangrail

TL36R 36" dia.
TL42R 42" dia.

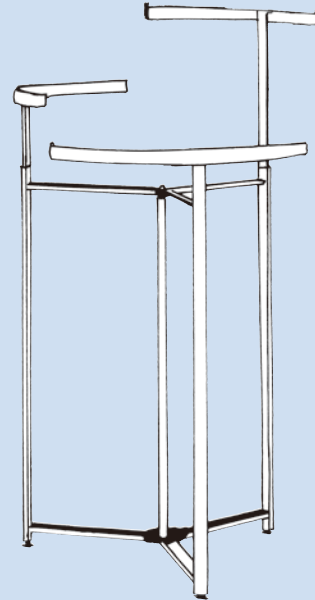

- 3 rect. curved hangrails 1/2" x 1-1/2"
- Each level adjusts independently from 48" to 72" every 3"
- Base of rack 5/8" x 1-5/8"
- Folds flat for easy storage
- Chrome finish

RR3L-36 36" dia.



GARMENT RACKS

ADJUSTABLE SINGLE BAR RACKS

MAY / 2011

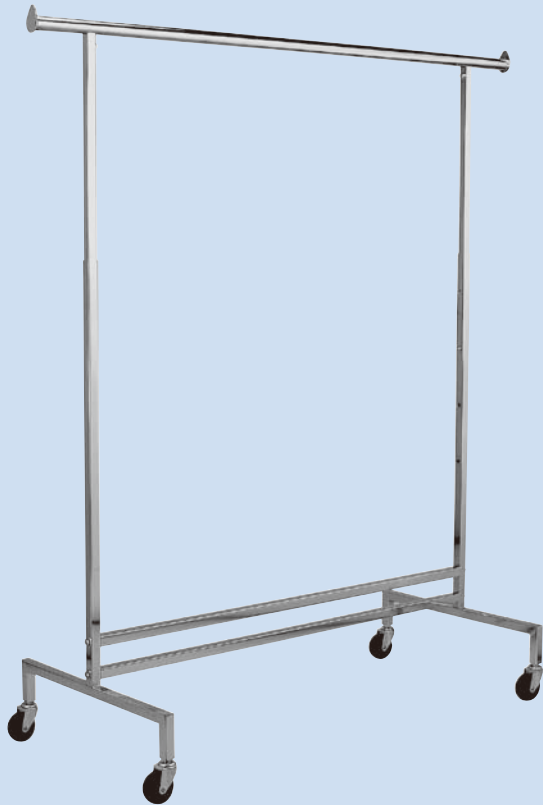

Single Hangrail Rolling Rack

- Strong 5' L 1-1/4" hangrail
- Fully adjustable from 48" to 72" every 6"
- Rolls smoothly and easily on sturdy 3" casters
- Polished chrome

RK43

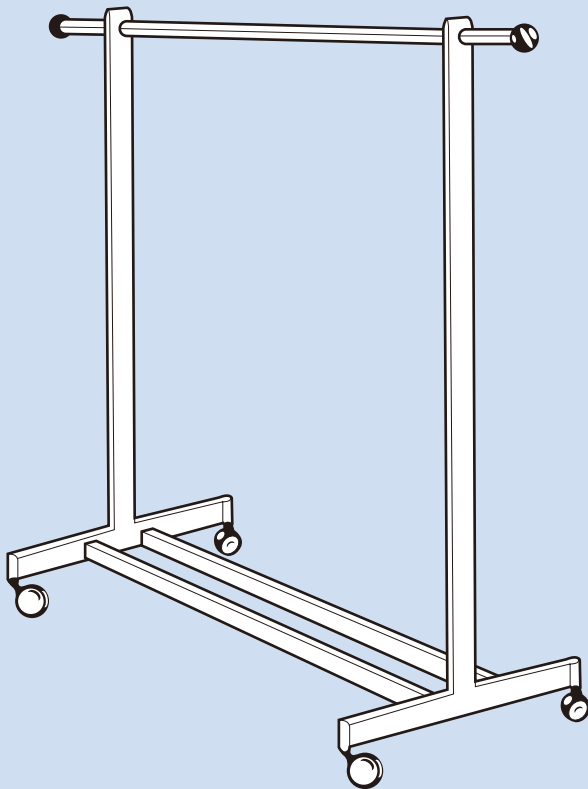

Single Hangrail Rolling Rack

- Constructed of 5/8" x 1-5/8" rectangular tubing
- 60" long with two 6" fixed end posts
- Adjusts from 51" to 75"
- Ball casters
- Chrome finish

SR5475

GARMENT RACKS

ADJUSTABLE DOUBLE BAR RACKS



- 5' L, 22" W. 1-1/4" tubing hangrails
- Adjusts 48" to 66" every 3"
- Chrome finish

SQDA-C

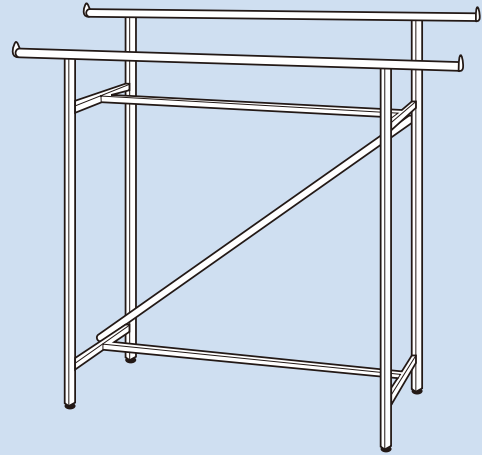

Same as #SQDA-C but with "Z" bar
SQDA-Z



Same as #SQDA-C but with "V" brace
SQDA-V

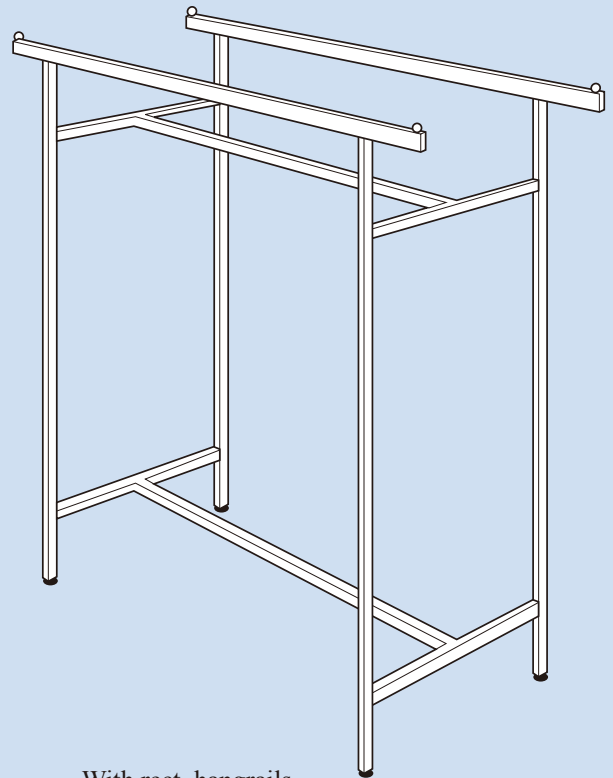

With rect. hangrails
• 5' L, 22" wide. 1/2" x 1-1/2" rect. hangrails
• Adjusts 48" to 66" every 3"
• Chrome finish
RQDA-C



GARMENT RACKS

ADJUSTABLE DOUBLE BAR RACKS

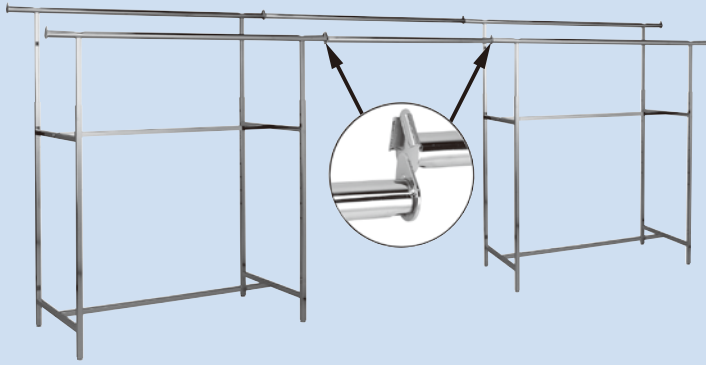

Add-on-Hangrail

- 5'L chrome hangrails
- Connects in seconds to tear drop end caps
- Chrome finish
- Pack 2 pcs per carton

AOH

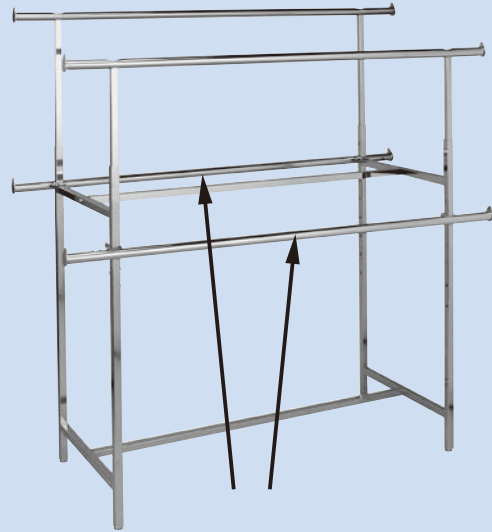

Clamp-on-Hangrail

- 5'L chrome hangrails
- Adjusts to 46" H
- Chrome finish
- Pack 2 pcs per carton

CLH

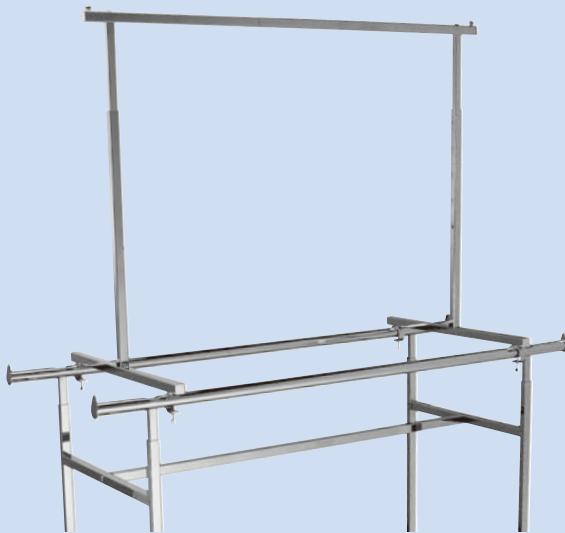

Add-a-Rail

- Adjusts from 36" to 48" above double bar racks
- Full 49-3/8" O.D. all chrome plated

RK49

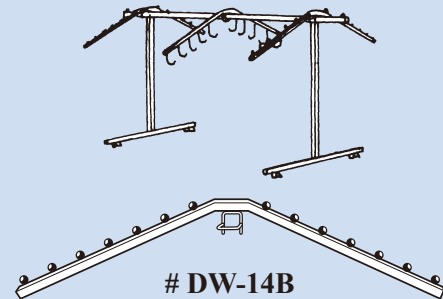

DW-14B

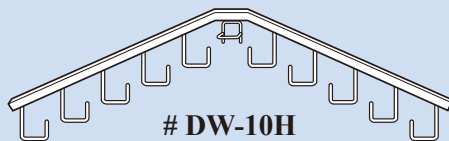

DW-10H

DW-14B
14 Ball Waterfall

DW-10H
10 Hook Waterfall

- Attaches to Add-a-Rail for two sides of selling
- Waterfall clamps easily over 1" sq. tubing
- Chrome finish

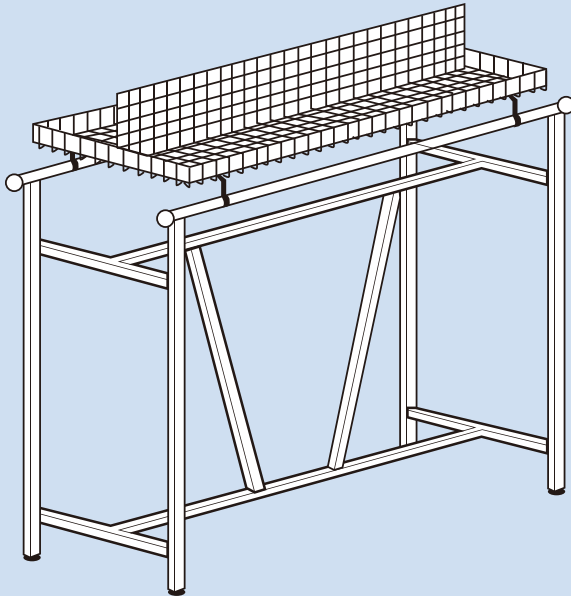

Grid Rack Topper For Rectangular Rack

- 23"×54" Grid rack topper has 3" lip on all sides. Adjustable legs accommodate racks from 18" to 24" wide with a 1-1/4" diameter hangrail.
- Maximizes existing selling space. Dust free. Easy installation. Ideal for accessories and related items.
- Optional 53-1/2" × 10" high center divider
- chrome finish

SQ-TP

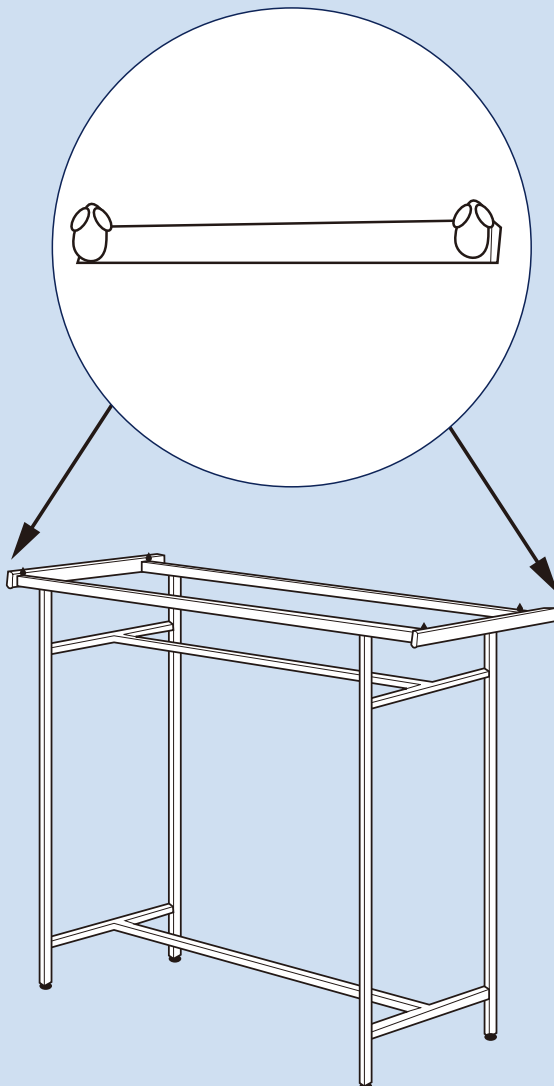

Add-on-Bar

- Made of 1/2"×1-1/2" rect tubing
- 22" long
- When double hangrails of #SQDA rack are in same plane, attaches in seconds to tear drop end caps.
- Chrome finish

AOB



GARMENT RACKS

MISCELLANEOUS RACKS

MAY / 2011

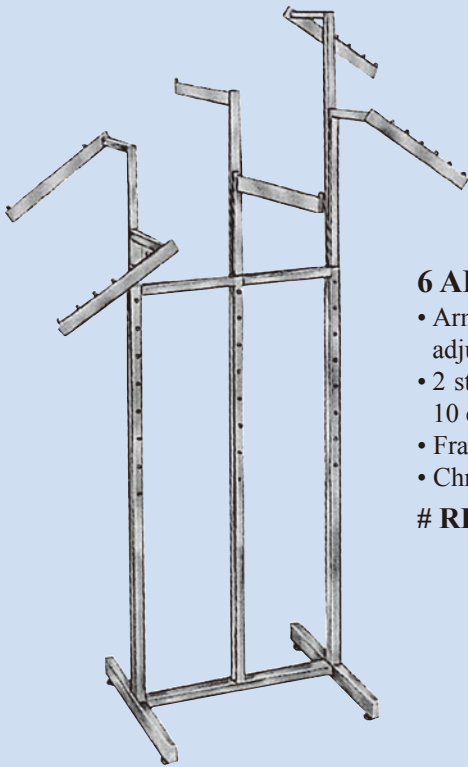

6 ARM RACK

- Arms made of 1/2"×1-1/2" rect. tubing, adjust from 48" to 72" every 3"
- 2 straight arms 16"L, 4 Slant arms with 10 cubes each
- Frame made of 1"×2" rect tubing
- Chrome finish

RK66

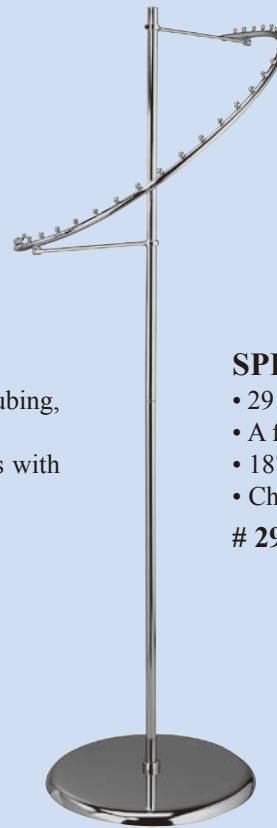

SPIRAL COSTUMER

- 29 ball stops
- A full 67" high
- 18" no-tip base
- Chrome finish

29SC



HALF ROUND RACK

- 1-1/4" hangrail, 43" Dia.
- 1" square tubing uprights
- Adjusts from 49" to 73" every 3"
- Chrome finish

RK62



ROUND REVOLVING RACK

- 36" Dia 1-1/4" round hangrail
- Adjusts from 52" to 72" every 5"
- Upright made of 2" round tubing
- Chrome finish

R436C

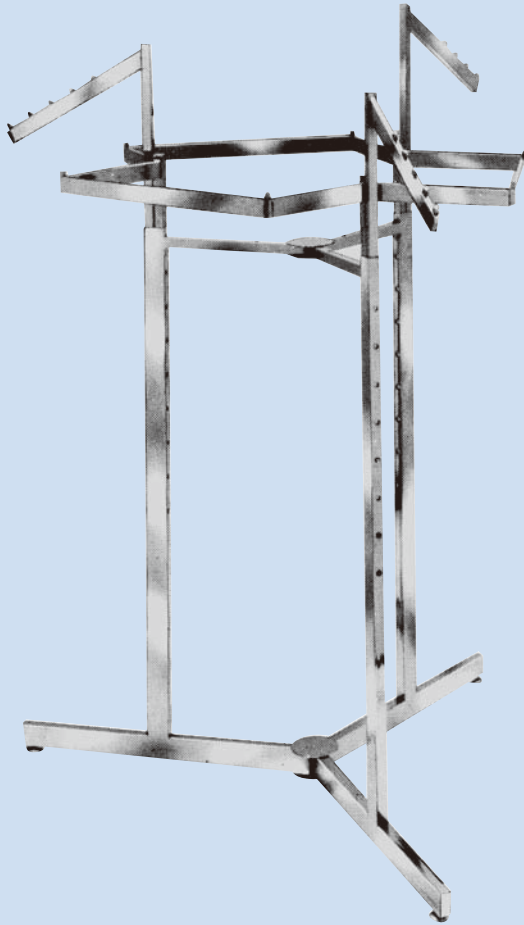

3 Plus 3 Rack

- 3 20" hangbars and 3 slant arms, each with 5 cubes
- Arms adjustable 54" to 78" every 3"
- Hangrails and arms are ½" × 1½" rectangular tubing
- Chrome finish

RK684S

Multipurpose Gondola Rack

- Adjusts from 48" to 66" every 3"
- Uses standard 5' shelves and hangrails
- 24"W×62"L to take up minimum floor space

R6403F





SPIRAL ADJUSTABLE ROUNDERS

- Round hangrail can be raised or lowered without removing garments.
 - Round hangrail adjusts from 48" tall to 68" tall.
 - Push button and turn the ring counterclockwise to raise the hangrail.
 - Push botton and turn the ring clockwise to lower the hangrail.
 - Hangrail revolves freely when button is not engaged.
 - Twin wheel casters are included, 2 brake & 2 non-brake.
 - Ships in flat cartons for lower transportation costs.
 - Matte black vertical post and base legs with a chrome rectangle hangrail is standard.
- All chrome models or satin chrome models or any powder coat color finishes may be available in quantities.

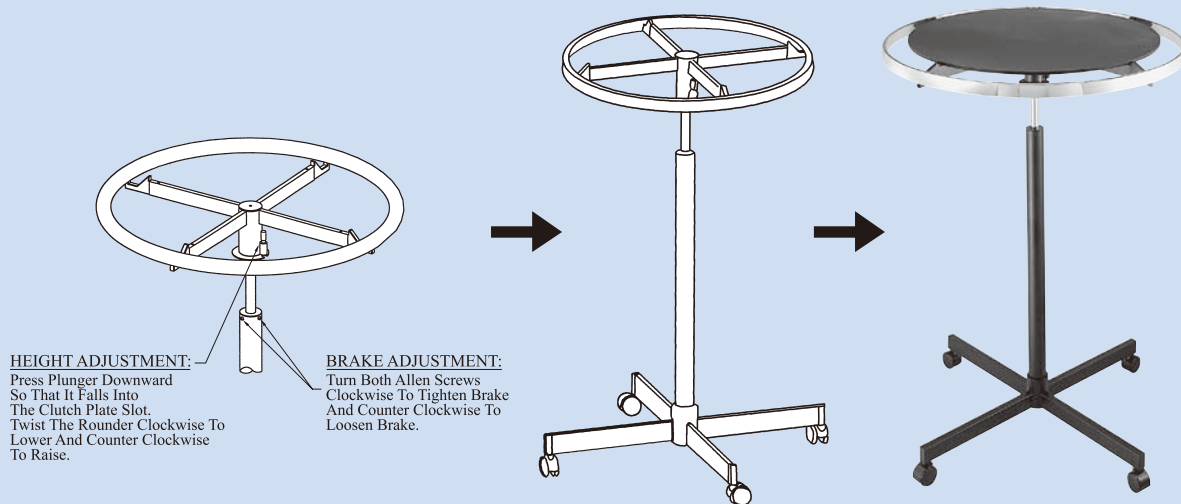

Item #	Description
SAR36MB	36" REVOLVING ROUNDER WITH NO TOP
SAR42MB	42" REVOLVING ROUNDER WITH NO TOP
SAR48MB	48" REVOLVING ROUNDER WITH NO TOP

OPTIONAL TOP:

TOP \ DIA	30"	36"	42"
BD	BD36	BD42	BD48
TG	TG36	TG42	TG48
GD	GD36	GD42	GD48
TO FIT ON	SAR36MB	SAR42MB	SAR48MB

BD = Black Disc top is made of hard plastic 3/8" thick, looks like a matte black wood.

TG = Tempered Glass top 3/16" thick.

GD = Green Disc top is made of green acrylic 3/8" thick with rounded edges, looks like glass, but stronger and safer.

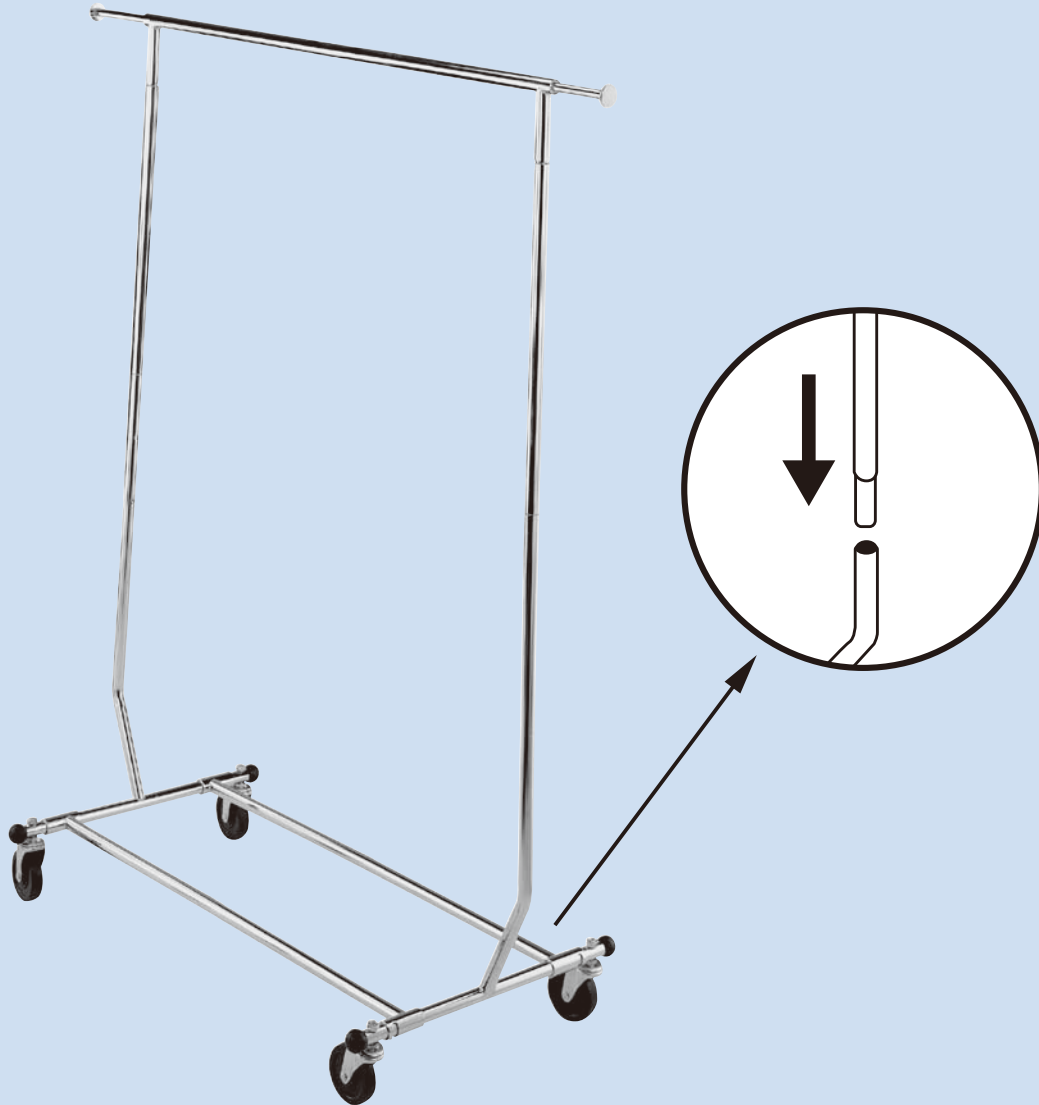

K/D ROLLING GARMENT RACK

- Made of 1" O. D. round tubing (17 Gauge) 50" Hangrail with two 12" pull-out, Two uprights are removable.
- Height is adjustable at 56", 61" & 66".
- 4 pcs of 4" ball bearing casters and 4 pcs of protective white bumpers.
- Collapsible design for easy storage.
- Chrome finish.

RCS-6

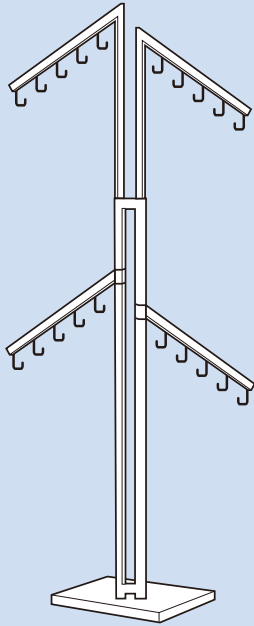

4 Arm Bag Displayers

- Each arm 18"L with 5 hooks
- Top arm adjust from 48" to 72" high at 3" intervals
- Chrome finish

R70-6



Two-Tier Handbag Displayer

- Each arm 18"L with 5 hooks
- Top arm adjust from 48" to 72" high every 3"
- Chrome finish

MQ8J

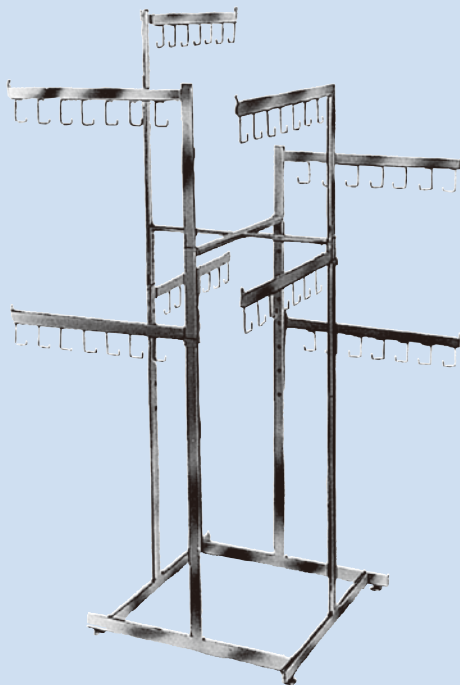

High Capacity Two-Tier Handbag Displayers

- Each arm 22"L with 7 hooks
- Top arm adjust from 48" to 72" every 3"
- Chrome finish

RK83

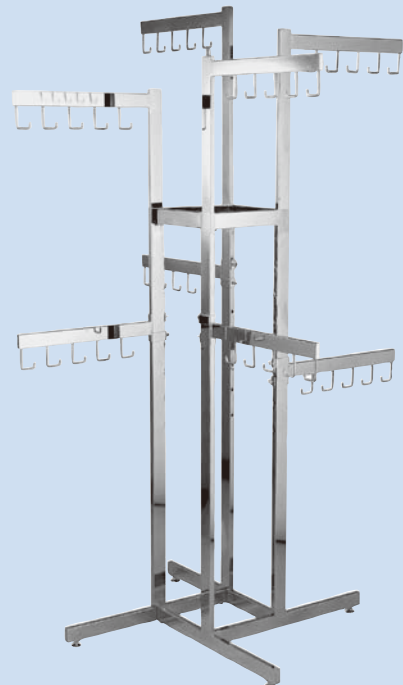

Two-Tier Handbag Displayers

- Each arm 16"L with 5 hooks
- Top arm adjust from 48" to 72" every 3"
- Chrome finish

RK88

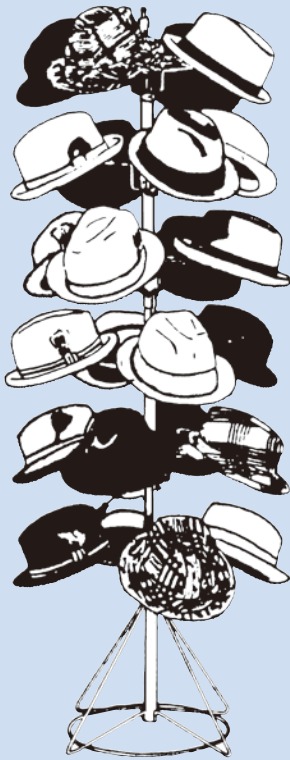

Revolving 24 Arm Hat Rack

- Six tiers each revolve individually
- Stands 64" H × 21" Dia
- # M1700C Chrome
- # M1700B Brass



Ladies Vertical Wall Hat Rack

- Holds 6 hats on 48" long strip
- # R333A Satin Silver
 - # R333B Satin Brass



Revolving Hat Tree

- Hold 20 hats.
- Upright is 72" × 1-1/4" on a 18" Round Base
- All chrome
- # CHT



Revolving 24 Arm Hat Tree

- Overall height is 69"×19" wide with heavy 15" base
- # 1971 Satin Silver
 - # 1972 Satin Brass

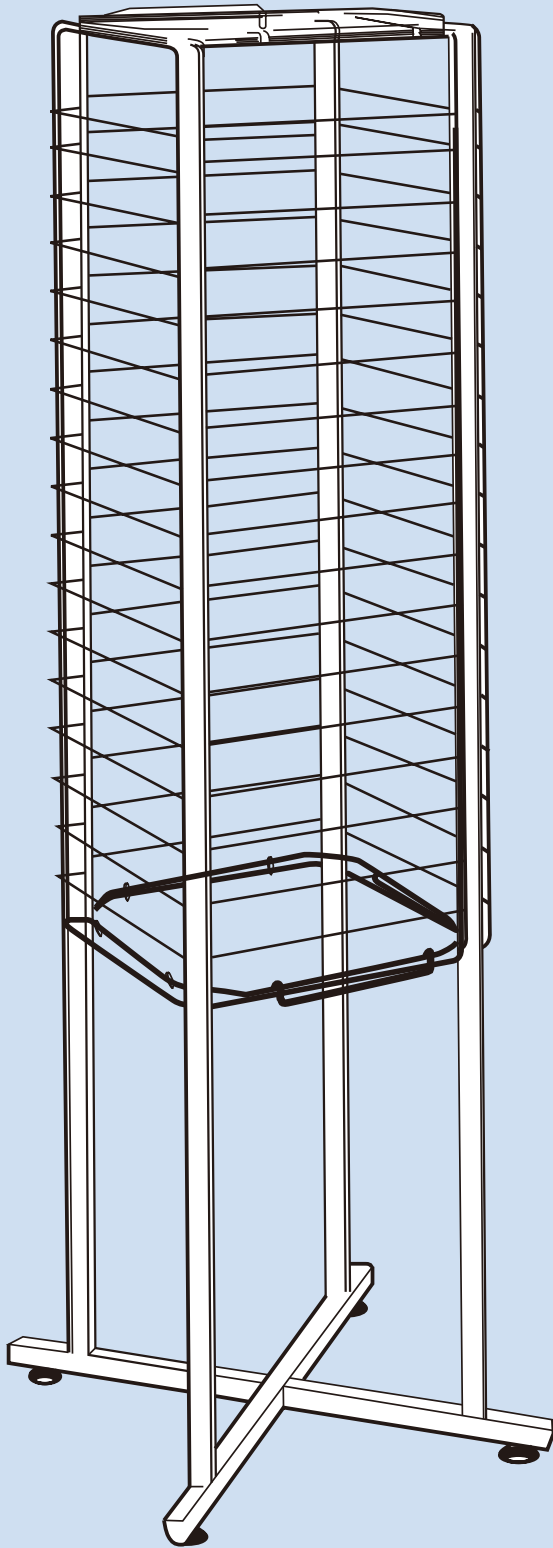

Folding Jewelry Tower

- 4 chrome plated panels each panel is 12" X 40"
 - Tubular frame is made of 1" sq. tubing
 - 61" high
- # RK34-37

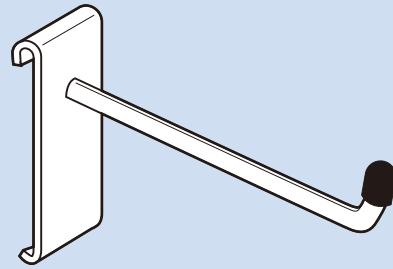

4" Jewelry Hook

Chrome plated
JH4

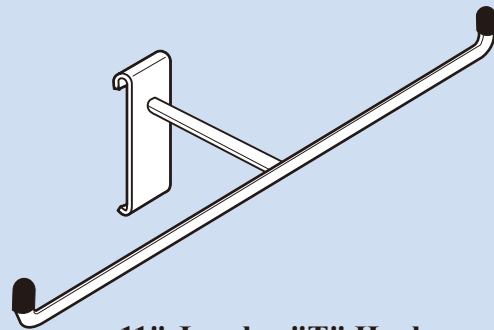

11" Jewelry "T" Hook

Chrome plated
JTH11



Folding Lingerie Tower
 1" Square tubing, Includes 16 twist-on 12" tubular arms, 61" High, With adjustable levelers, 3/8" fitting for card holders, Chrome plated.
RK35



Folding Lingerie Tower
 1" Square tubing, Includes 16 twist-on 1/2" x 1" - 12" long rectangular tubing arms, 61" High, With adjustable levelers, 3/8" fitting for card holders, Chrome plated.
RK36

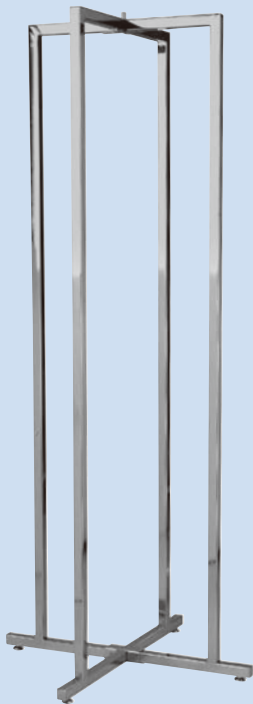

Folding Tower
 Same as RK35 but with no arms
 Chrome plated.
RK34



Twist-on Straight Arm
 1/2" x 1" Rectangular tubing
 12" Long, Chrome.
TV-RT



Twist-on Straight Arm
 5/8" Round tubing with disk end
 12" Long, Chrome.
TV-RD



Collapsible Salesman Rack

- 1" O.D. round tubing. 50" hangrail with two 12" pull-out
- Height is adjustable at 56", 61" and 66".
- 4" ball bearing casters. includes clips for hangrail storage and protective white bumpers.
- Chrome finish

RCS-1

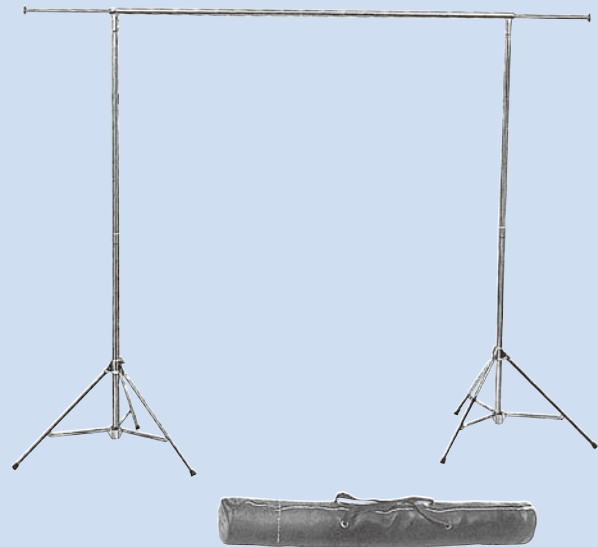

Tripod Salesman Rack

- 1" O.D. round tubing. 60" hangrail with two 12" pull-out
- height is 66". Rubber tips on all tripod legs.
- Disassembles for easy storage in the free heavy duty vinyl zippered carrying case.
- Chrome finish

RTD-1



Collapsible Salesman Rack- Square Tubing

- Same as #RCS-1, but made of 1" square tubing

RCS-1-SQ

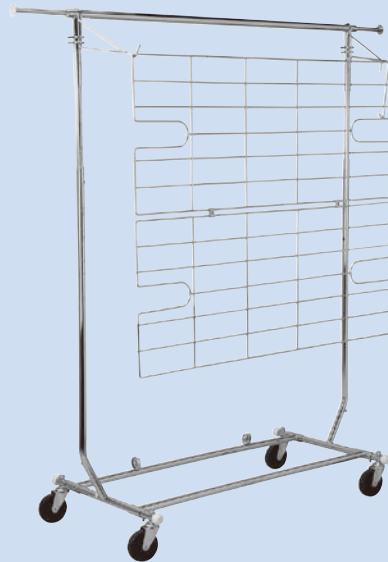

Shelf/Display Screen

- Chrome plated, includes two connecting brackets and one stabilizing hook.
- Folded in half acts as merchandise shelf
- When opened use as a display screen for exhibiting merchandise.
- Fits both RCS-1 & RCS-1-SQ

DS



SALESMAN RACK

MAY / 2011

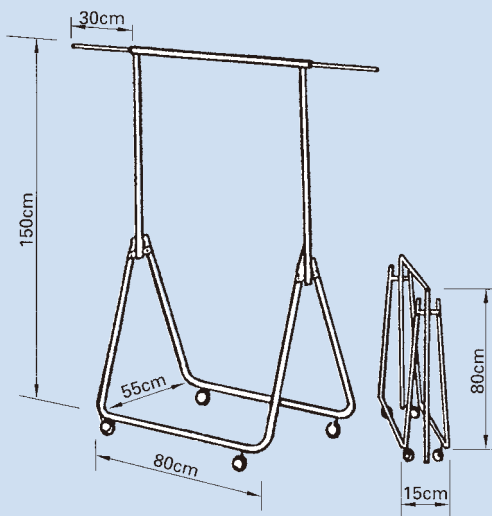
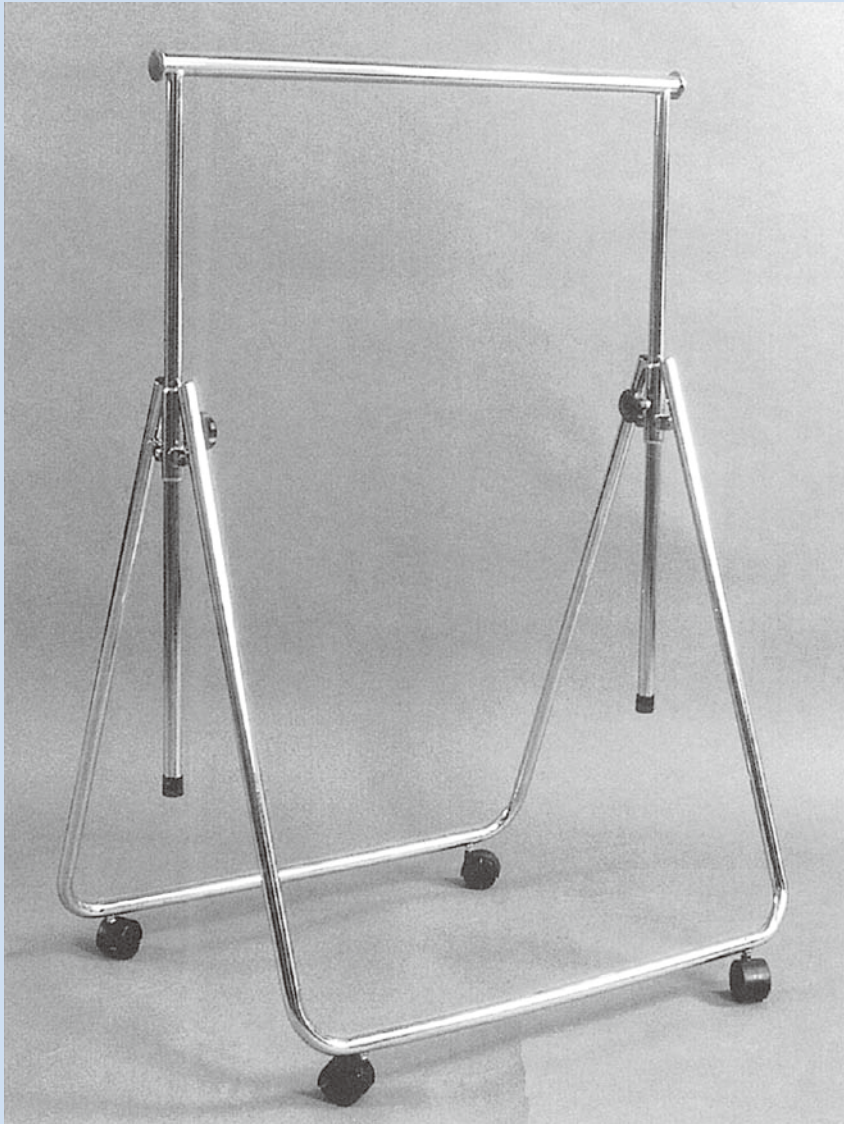

FOLDING SALESMAN RACK

With extensible arms, chrome finish
4pcs. plastic casters included.

FSR

R-13-02



COLLAPSIBLE SALESMAN RACK

- Made of 1" O. D. round tubing double 50" hangrail with two 12" pull-out.
- Height is adjustable at 56", 61" and 66".
- 4" ball bearing casters, includes clips for hangrail storage and protective white bumpers.
- Chrome finish

RCS-3



SMALL COMMERCIAL GARMENT RACK

Extra storage for clothes and shoes, chrome-plated with commercial-style construction. Single bar expands to 60" long and 65" high for more space; grid shelf holds shoes, hats, folded items below. Durable casters for easy mobility. Simple assembly.

36" × 18" × 55"H

RCS-4

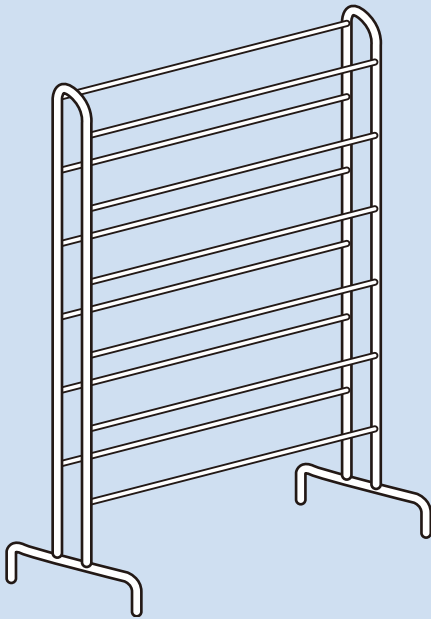

SINGLE SIDED SHOE RACK

- Constructed of Heavy Duty Round Tubing
- 56-1/2" H x 41-1/2" W x 14" D
- Chrome finish

SSJ-110

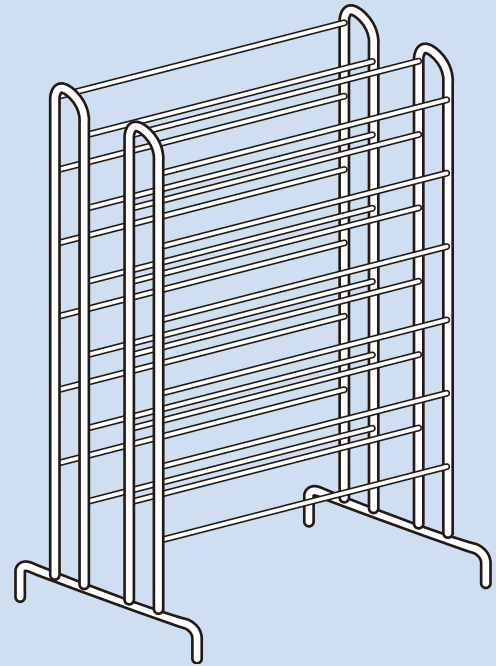

DOUBLE SIDED SHOE RACK

- Constructed of Heavy Duty Round Tubing
- 56-1/2" H x 41-1/2" W x 20" D
- Chrome finish

SSJ-120

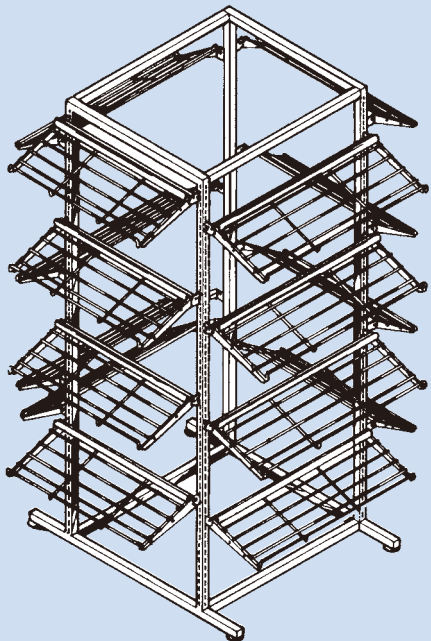

SQUARE STYLE SHOE RACK

- Frame 1" SQ. Tubing
- 24" W x 24" L x 66" H
- 4 Pcs Folding Shoe Shelf. Total 16 Pcs.
- Chrome finish

SSQ-24

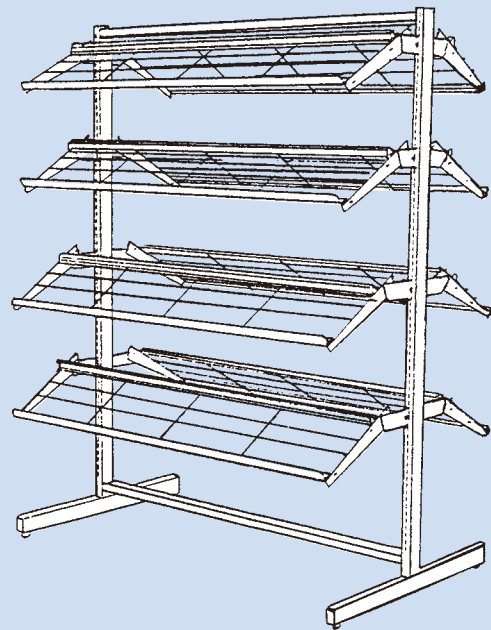

"T" STYLE SHOE RACK

- Double Unit, 66" H x 48-1/2" W
- 8 Shelves, each Size: 12" x 47-1/2"
- Chrome finish

SSJ-128R Shoe Rack

SSJ-128RS Shoe Shelf

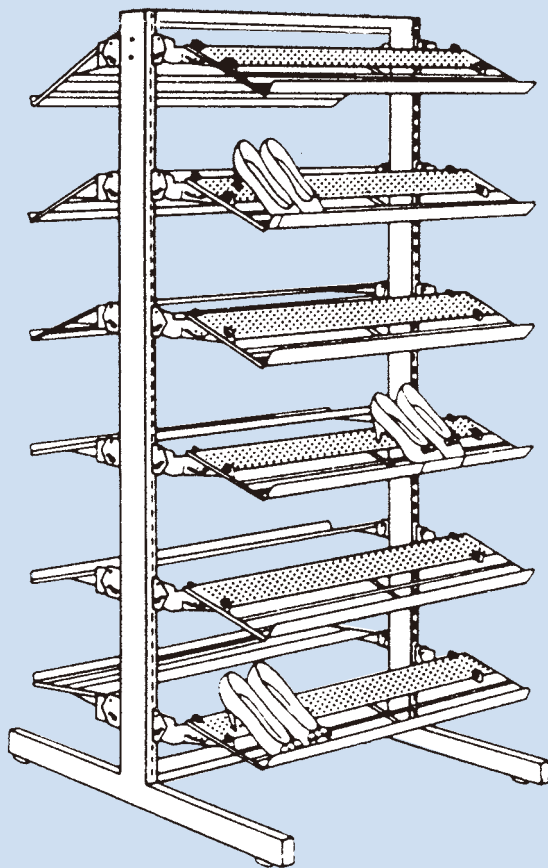
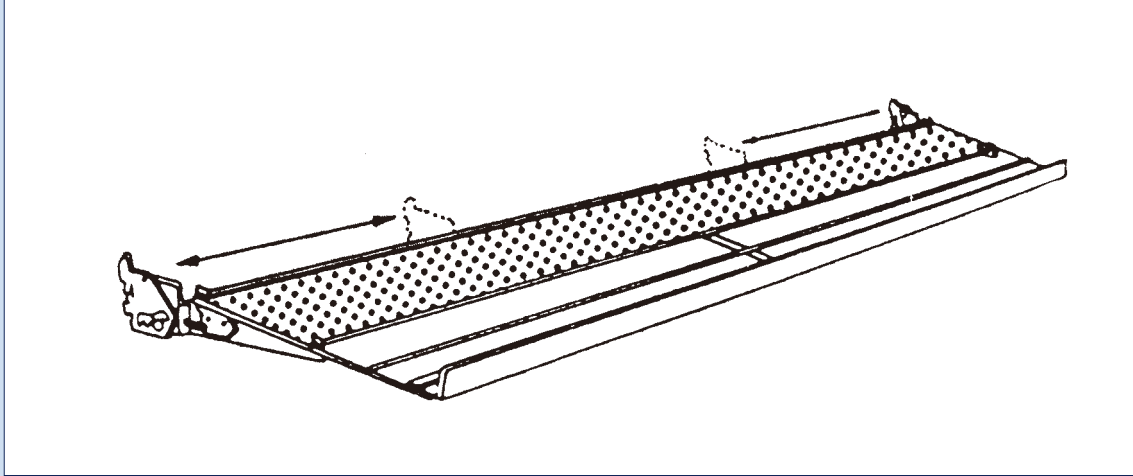

Shoe shelves mounted on "T" frame

Chrome Metal Shoe Shelf

Perforated metal shelf with 1" retainer lip. Sliding brackets adjust to various spacing of standards up to 60" center to center. fits all 1/2" slotted standards and our standard "T" and "L" frame units. Adjustable angles include, straight, 10, 25, and 40 downslants.

- # JB24 10" × 24"
- # JB30 10" × 30"
- # JB36 10" × 36"
- # JB48 10" × 48"
- # JB60 10" × 60"

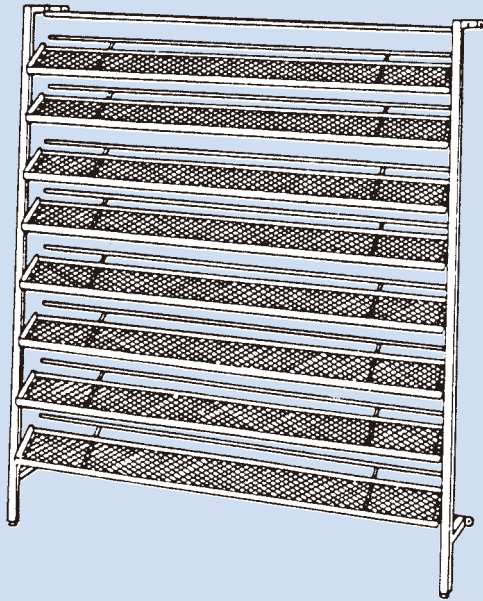

Wall Mounting Shoe Displayer

75" High 62" Long 12" Wide, 8 Mesh shelves with adjustable heel rests. Holds 72 to 80 pairs of shoes. Specify black or white enamel.

- # **WR8** Wall Displayer
- # **WR8TA** Add on Unit

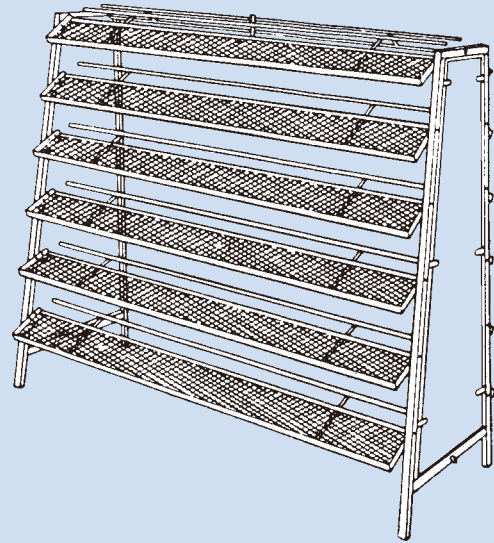

Self Standing Shoe Displayer

Proven in use by thousands of satisfied customers. Finished in beige enamel. 6 Mesh shelves on each side with fixed heel rests. Displays 108 pairs of shoes (120 pairs in boxes). 54" High, 62" Long, 26" Wide.

- # **R711** Shoe Displayer
- # **R711TA** Add on Unit

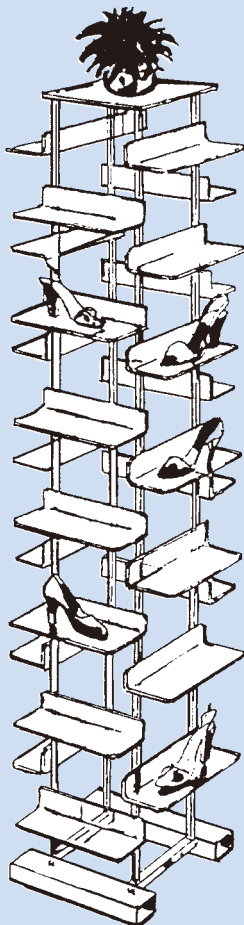

28-Tiered Shoe Display

Four sided floor unit on 2" thick plexi base. 60" high with 28 - 4" x 10" shoe brackets with back lip. Overall width at widest point, 17". Chrome hardware.

1911C

20-Tiered Motorized Turntable Shoe Display

Four sided floor unit on motorized revolving base. 45" high with 20 - 4" x 10" shoe brackets with back lip. Overall width at widest point, 17". Chrome hardware.

1912C

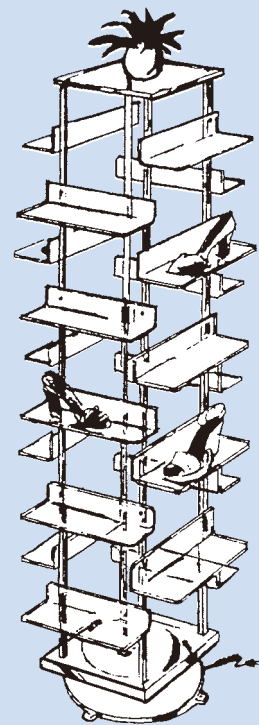

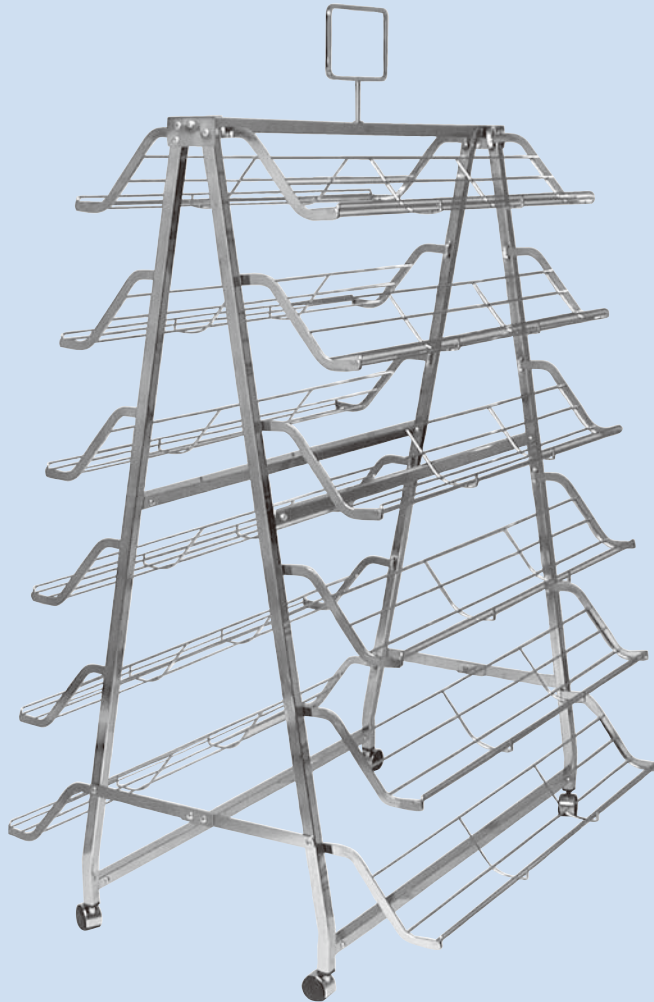

FOLDING TWO-SIDED SHOE RACK

62" high x 44" long, chrome plated

- Frame is 1" square tubing
- Folds for storage
- Includes twin wheel casters, 2 locking & 2 non-locking and 7" x 11" sign holder
- Displays 144-168 women's shoes, also displays men's shoes
- Six 42" wide shelves on each side snap in or out for seasonal needs
- Shipped K.D. - easy assembly

SSJ-RH



CROSSBAR DISPLAYER

Unit has ten crossbars, two 10" pullouts and ball casters, 54" Long, 60" High, 16" Wide. Polished chrome.

B15017

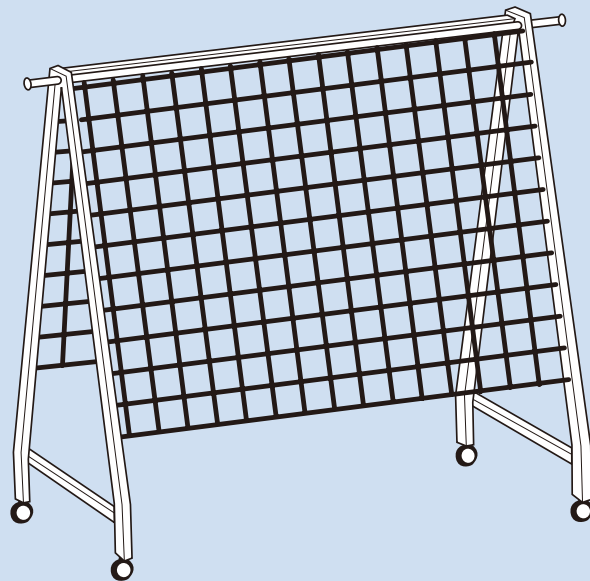

GRID DISPLAYER

Same as #B15017 but with two 56" x 48" grids

B18263

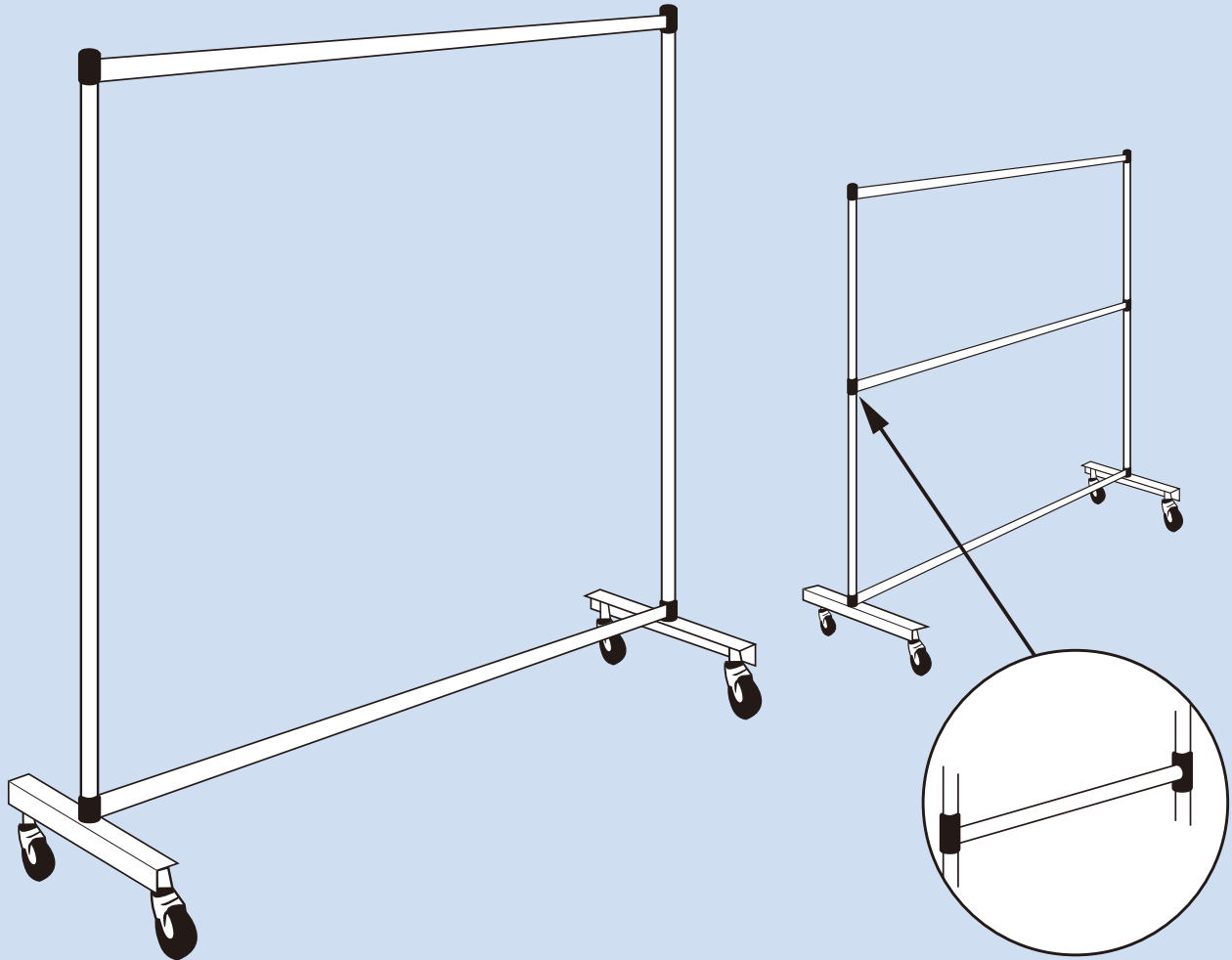

HEAVY DUTY INDUSTRIAL RACK

- A full 70"H × 66"L
- Made of 1-1/4" chrome tubing
- Super durable & super solid base
- Base is all welded construction featuring heavy steel angle iron
- Large 4" ball bearing casters mounted for easy mobility under the heaviest loads

R504

ADD-ON HANGBAR

- Gives your double hanging for double selling
- Adjustable 1-1/4" chrome tubing
- Attaches easily for quick set up
- Pictured on a #R504 rack

R504-AO



**DESIGNED
TO NEST FOR
STORAGE**

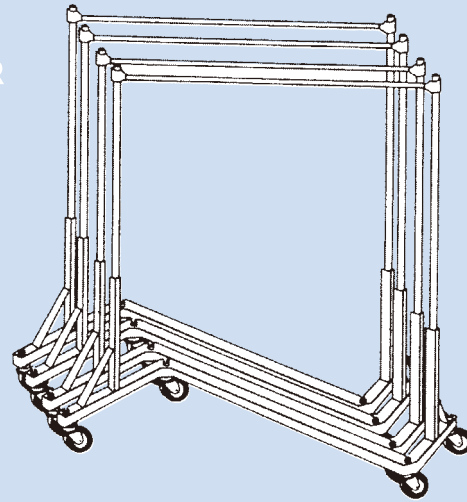

STOCKROOM Z RACK

Sturdy enough for the stockroom.

Nice enough for selling floor use.

- 69" High, 60" Long, 22" Wide base.
- Black Z base allows nesting of racks.
- Chrome uprights and hangrail,
Made of 1-1/4" round tubing.
- 4" industrial casters, non-locking.
- Slip together assembly.

EZ1

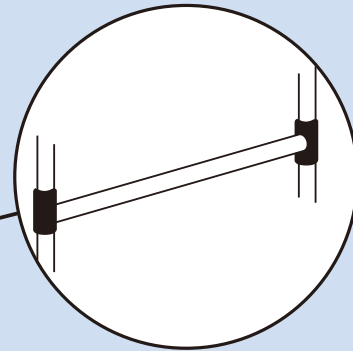

ADD-ON HANGRAIL

Made of 1-1/4" round tubing
60" Long, chrome .

EZ1-AO

T AND L FRAME



1" x 2" vertical and horizontal beams-16 gauge steel verticals have universal slotting-1/2" slots on 1" centers. End verticals have single slotting & center verticals have double slotting.

All legs have metal-clad levelers. Swedged stem holes provided on top of horizontal beams (for sign holders) All legs on L-Frames are 18", on T-Frames are 36".

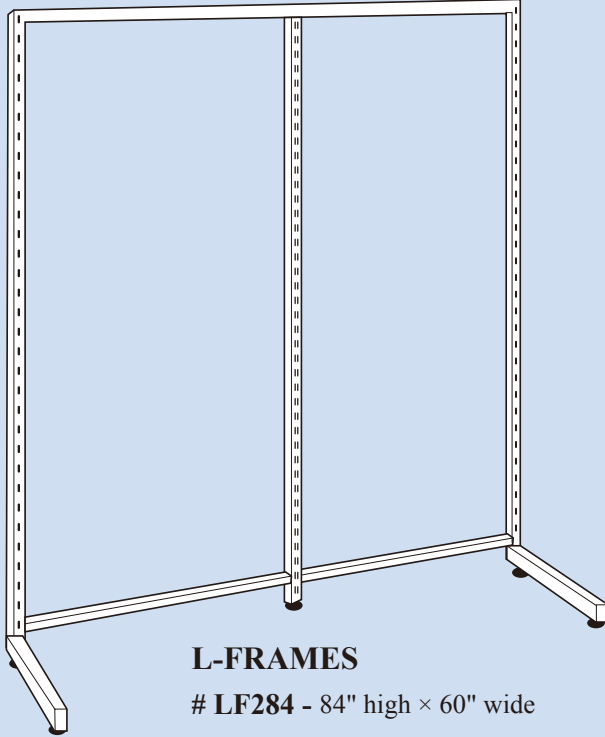

L-FRAMES
LF284 - 84" high x 60" wide

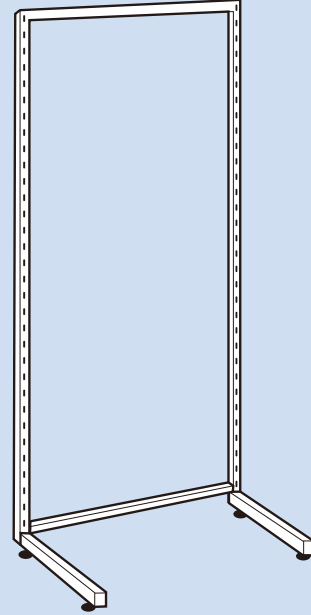

L-FRAMES
LF156 - 56" high x 30" wide
LF166 - 66" high x 30" wide
LF184 - 84" high x 30" wide

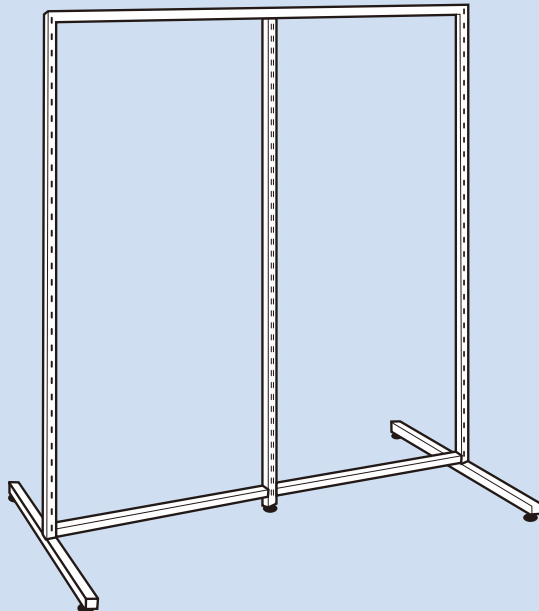

T-FRAMES
TF256 - 56" high x 60" wide
TF266 - 66" high x 60" wide

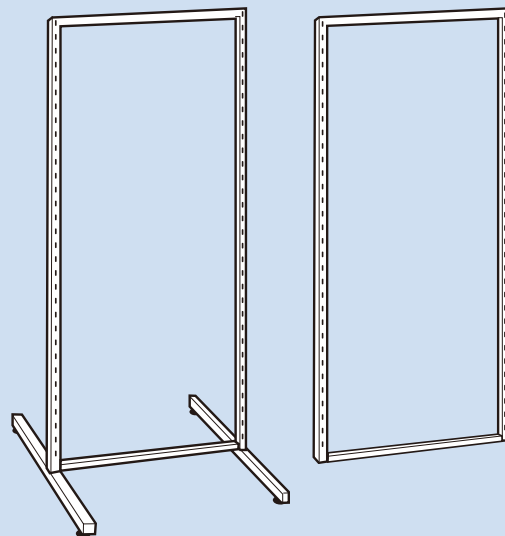

T-FRAMES
TF156 - 56" high x 30" wide
TF166 - 66" high x 30" wide

END FRAMES
EF156 - 56" high x 36" wide
EF166 - 66" high x 36" wide

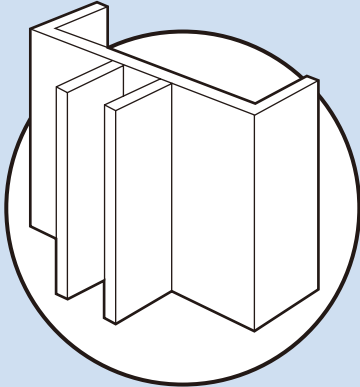

MOLDED CHANNEL CLIP

To hold acrylic panel or any 1/4" material used (masonite, peg board, etc.). Made of rigid translucent vinyl- 3" long.

CLP

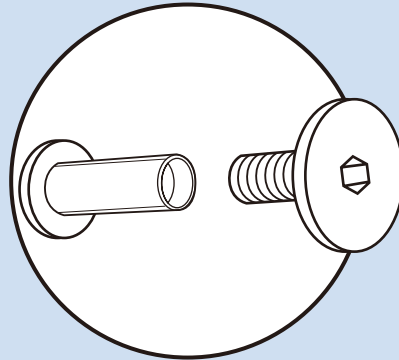

CONNECTING HARDWARE

For use in connecting T-Frames together horizontally for multi-unit extensions.

CH

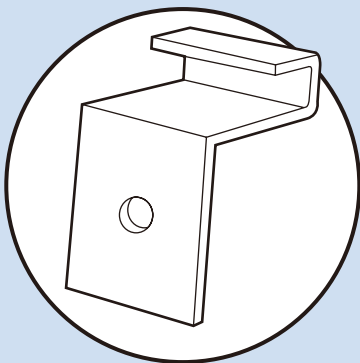

END FRAME CLIP

For use in locking L-Frame or End Frame to T-Frame Module-top & bottom Polished chrome. Comes with bolts & nuts.

EFC

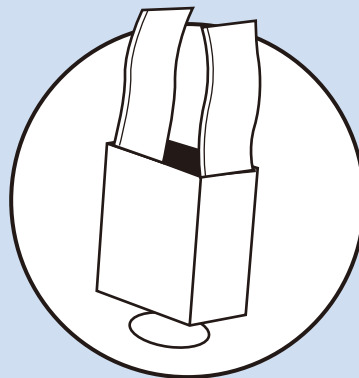

STUB LEG

For use instead of regular leg in multi-unit extension. Polished chrome-2" high plus metal-clad leveler.

SL

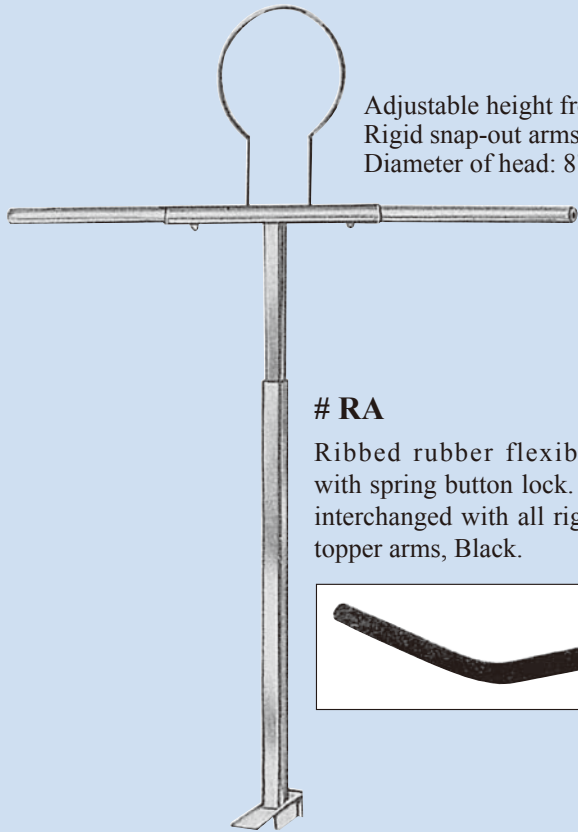

Adjustable height from 37" to 52"
Rigid snap-out arms-Arm Spread: 36"
Diameter of head: 8"

RA

Ribbed rubber flexible arm with spring button lock. Can be interchanged with all rigid rack topper arms, Black.

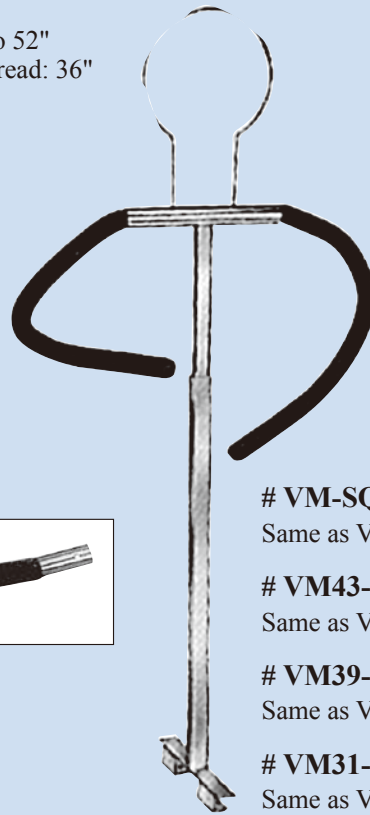

VM-SQ-RA

Same as VM-SQ, but with flexible arms.

VM43-RA

Same as VM43, but with flexible arms.

VM39-RA

Same as VM39, but with flexible arms.

VM31-RA

Same as VM31, but with flexible arms.

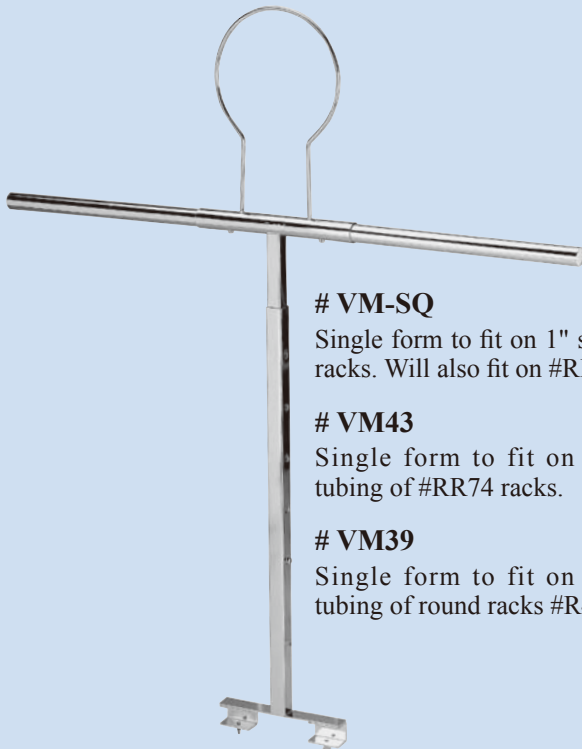

VM-SQ

Single form to fit on 1" square tubing racks. Will also fit on #RR22 racks.

VM43

Single form to fit on rectangular tubing of #RR74 racks.

VM39

Single form to fit on rectangular tubing of round racks #R436C

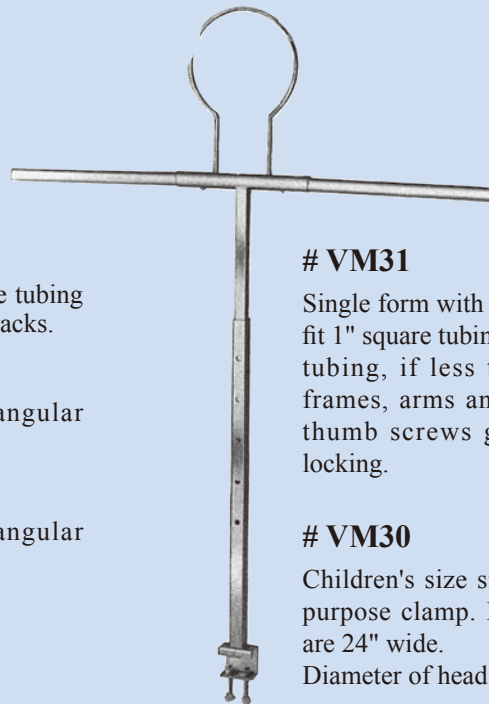

VM31

Single form with all-purpose clamp to fit 1" square tubing and all rectangular tubing, if less than 2". (For rack frames, arms and hangrails). Twin thumb screws guarantee positive locking.

VM30

Children's size single form with all-purpose clamp. Rigid snap on arms are 24" wide.
Diameter of head: 6"



TOPPERS

Adjustable height from 37" to 52"
Rigid snap-out arms-Arm Spread: 36"
Diameter of head: 8"

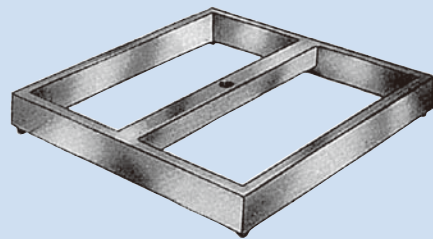
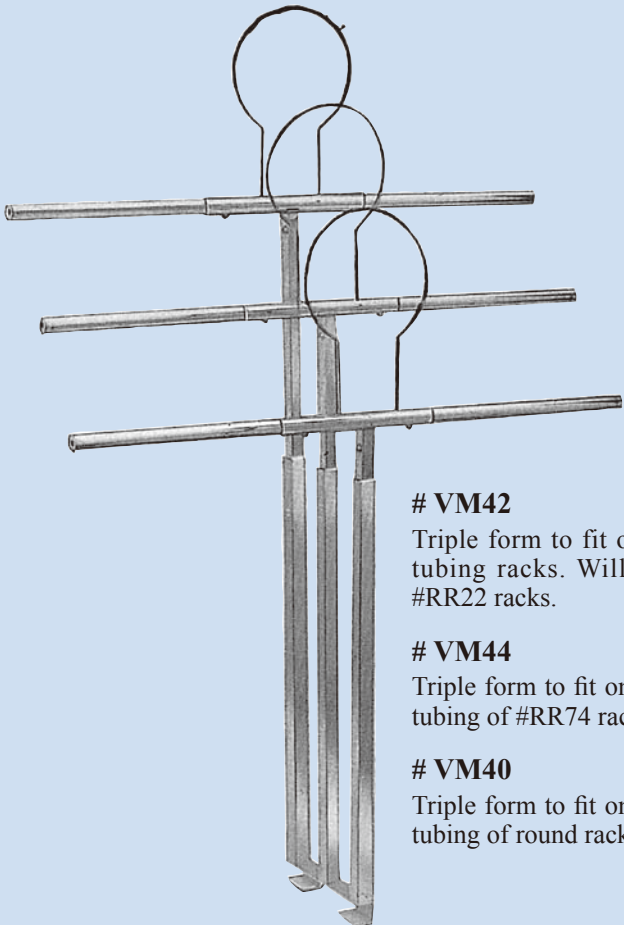
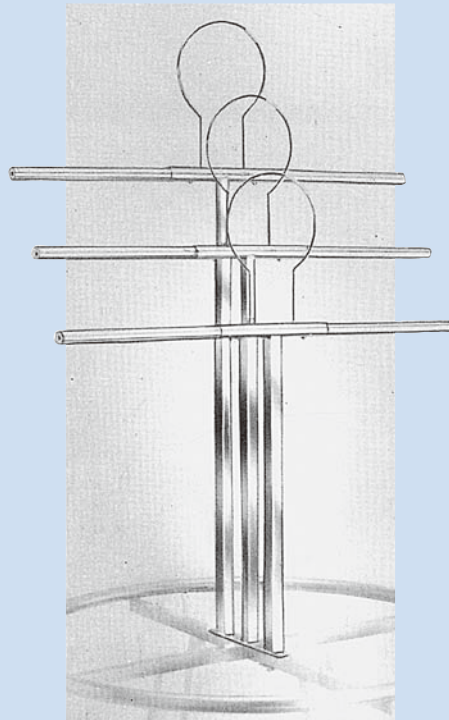
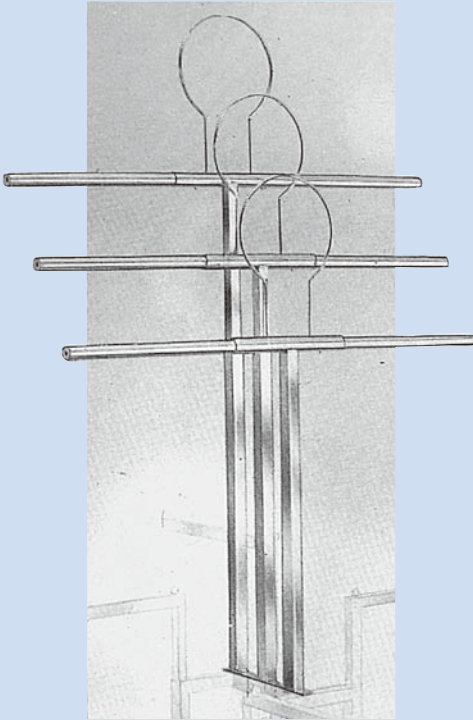

VM42

Triple form to fit on 1" square tubing racks. Will also fit on #RR22 racks.

VM44

Triple form to fit on rectangular tubing of #RR74 racks

VM40

Triple form to fit on rectangular tubing of round racks #R436C

VMB12

12" square base-chrome plated-perimeter made of 1/2"×1-1/2" rectangular tubing - cross bar made of 1" square tubing (recessed on bottom).

5/8" threaded receptacle. includes 4 rubber cushions on bottom corners. For holding VM-SQ or VM42 rack toppers or any 5/8" upright.

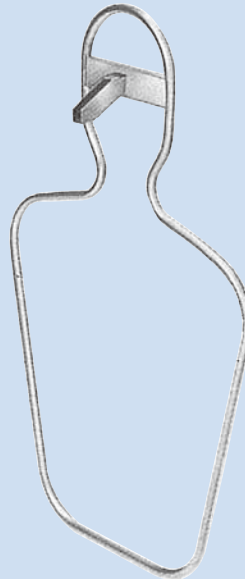
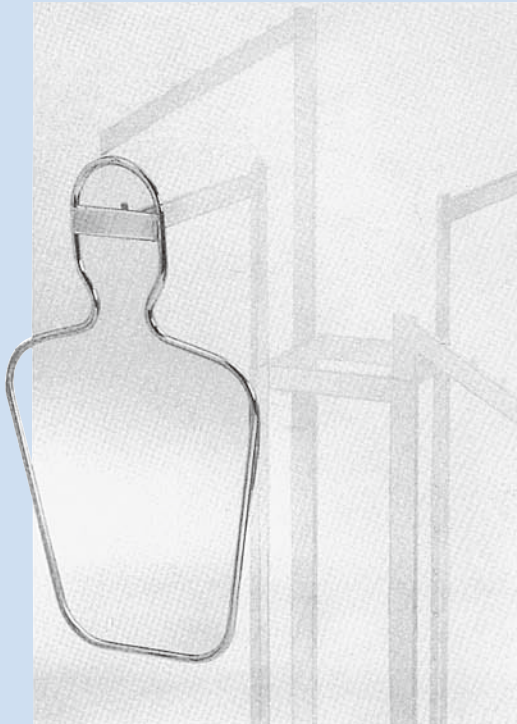

TUBULAR FORM

Chrome Plated
With snap-on attachments to fit
on rack arms 16" shoulder width

VM48
For square tubing arms &
face-outs (with tab end)

VM49
For rectangular tubing arms &
face-outs (with tab end)

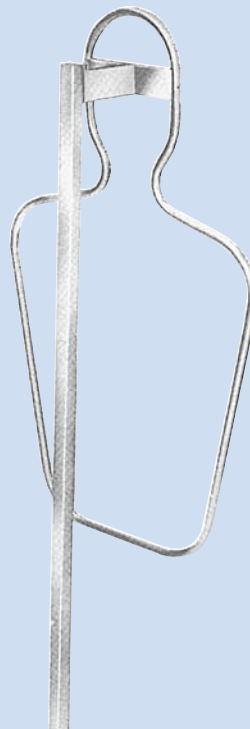
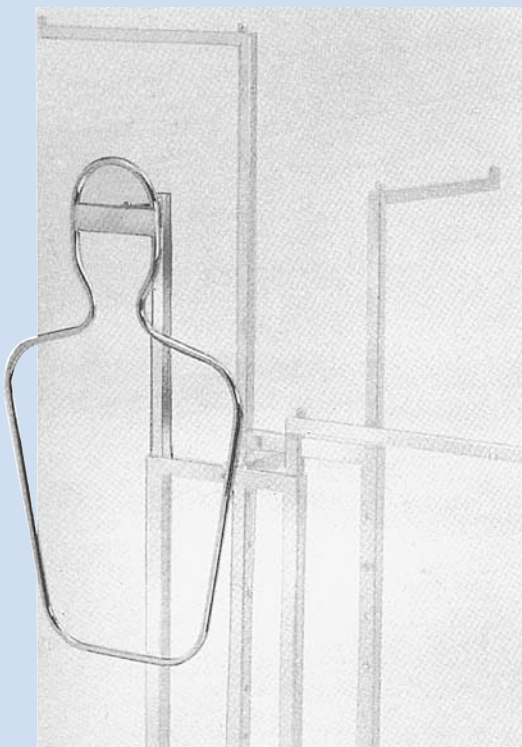

TUBULAR FORM ATTACHED TO ADJUSTABLE ARM

Chrome Plated
For 2 and 4 arm racks. 16"
shoulder width. This arm can
replace existing rack arms.

VM46
For square tubing racks.

VM47
For rectangular tubing racks.



TOPPERS

■ Chrome Plated ■ 16" Shoulder Width

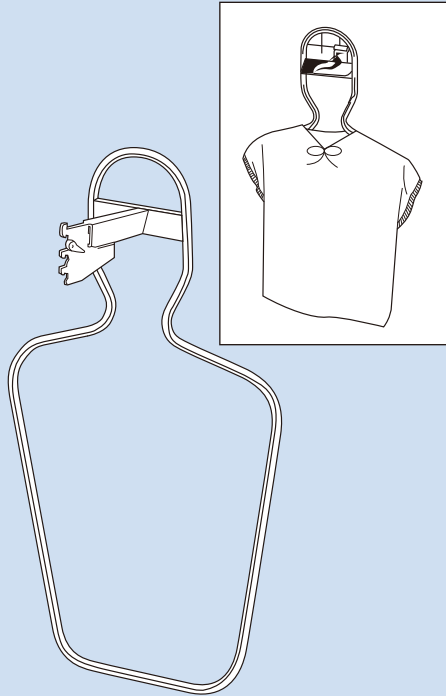

VM50
To fit on universal slotted standard

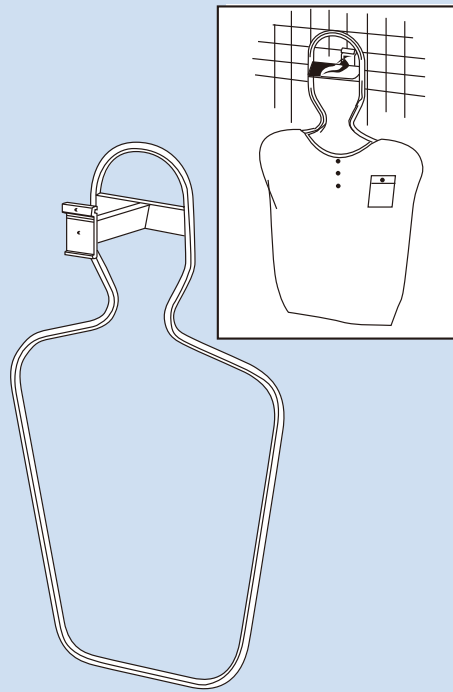

VM-GW
To fit on grid wall

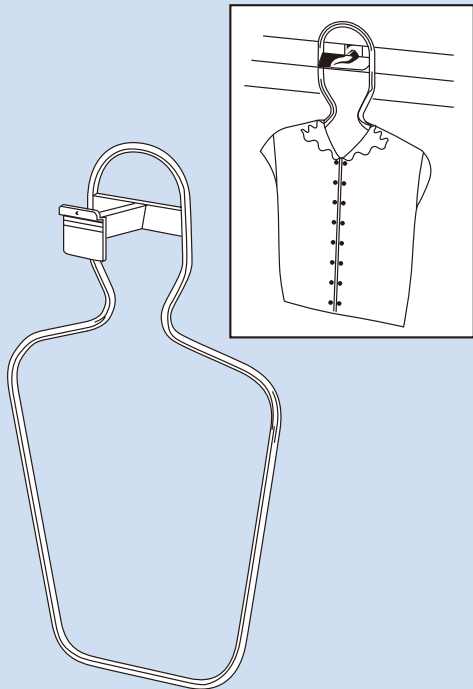

VM-SW
To fit on slat wall



PILLOW DISPLAY STAND WITH 5 WIRE SHELVES

- Frame is made of 7/8" sq. tubing
- 5 Wire shelves attached
(50.5 cm O.D. x 40.5 cm Depth)
- 2 attached product brochure holder
Large : 22 cm x 28 cm
Small : 15 cm x 21 cm
- All in glossy blue powder coating
- With 4 pcs of 2" black casters
(2 locking & 2 non-locking)

FDS-5

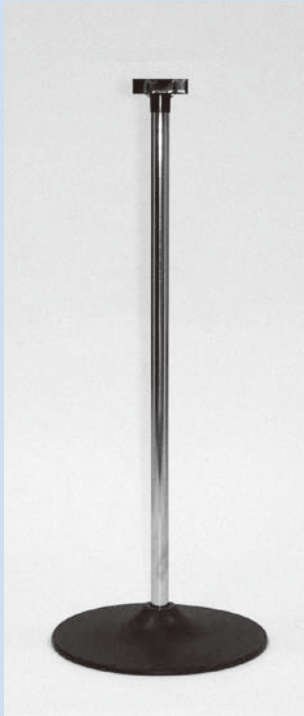

31" HIGH COUNTER TOP DISPLAY

With 12" Dia Black Durable
Plastic Base

CT



63" HIGH FLOOR RACK

With Wire Base

WB



63" HIGH FLOOR RACK

With Tubing Base

TB



63" HIGH FLOOR RACK

With 5- Claw Tubing Base

5TB



SPINNERS COMPONENTS

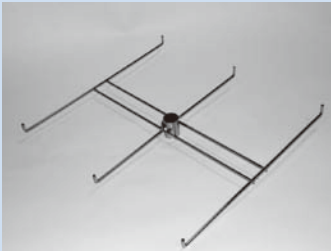

6 HOOK SPINNER
6H



8 HOOK SPINNER
8H



10 HOOK SPINNER
10H



> **12 HOOK SPINNER**
12H



WIRE BASKET
22"dia. top, 10"dia. bottom
7" deep
BT



GREETING CARD SPINNER
For 5" x 7" card
CA

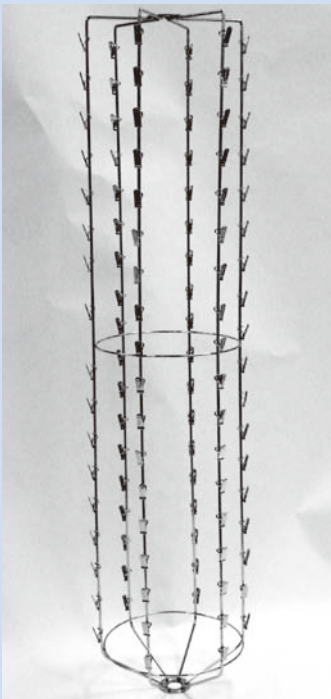

6 STRAND WIRE CLIP STRIP
53 1/8" high
CS

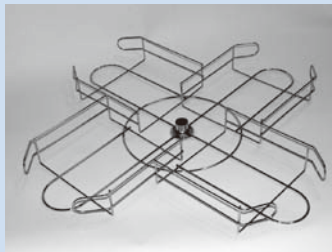

BASEBALL CAP SPINNER
CP



DVD SPINNER
DV



HAT SPINNER
HT



LITERATURE SPINNER
12" wide
LT



31" HIGH COUNTER TOP DISPLAY

Each unit including 12" dia. black durable plastic base, adjustable spinner holder and sign holder.

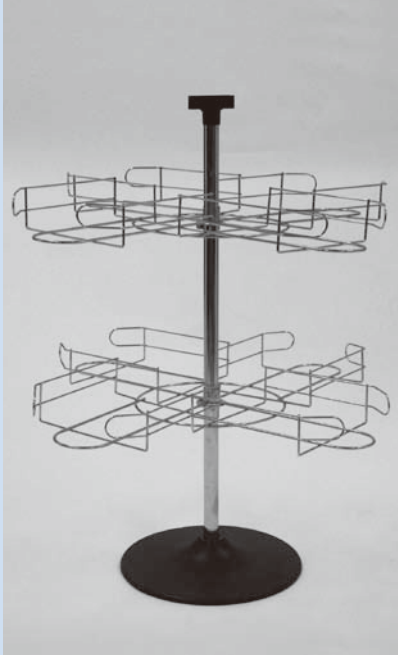

CTCP
(As photo shown, base on applicable components, mix and match for complete spinner unit.)

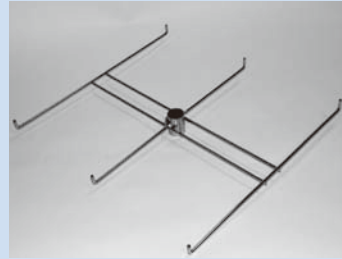

CT6H
2-tier 6 hook spinner

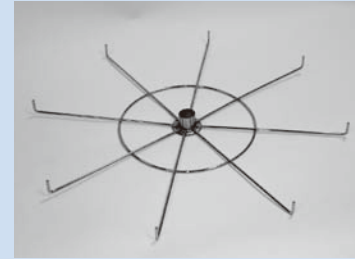

CT8H
2-tier 8 hook spinner



CT10H
2-tier 10 hook spinner

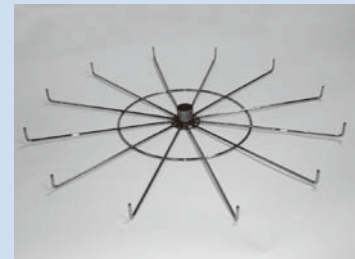

CT12H
2-tier 12 hook spinner



CTCA
2-tier greeting card spinner

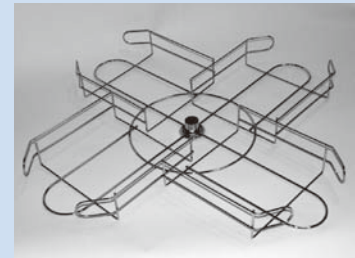

CTCP
2-tier baseball cap spinner



CTDV
2-tier DVD spinner



CTHT
2-tier hat spinner

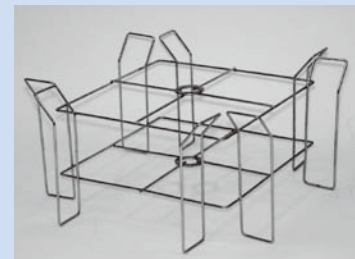

CTLT
2-tier literature spinner

• BT & CS are not available for CT (Counter Top Display).



63" HIGH FLOOR RACK

Each unit including wire base, adjustable spinner holder and sign holder.

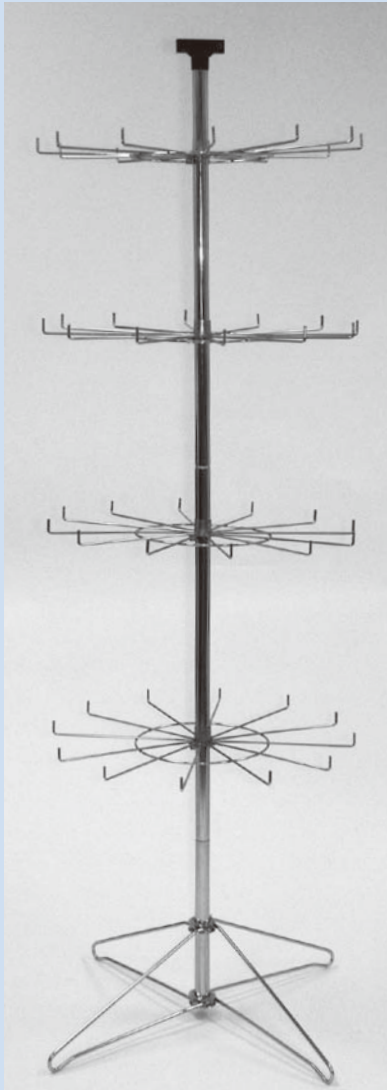

WB12H
(As photo shown, base on applicable components, mix and match for complete spinner unit.)

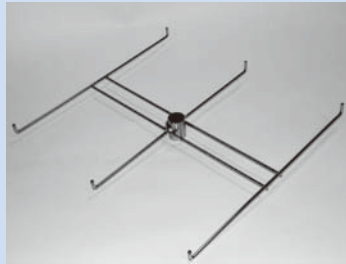

WB6H
4-tier 6 hook spinner



WB8H
4-tier 8 hook spinner



WB10H
4-tier 10 hook spinner



WB12H
4-tier 12 hook spinner



WBCA
4-tier greeting card spinner

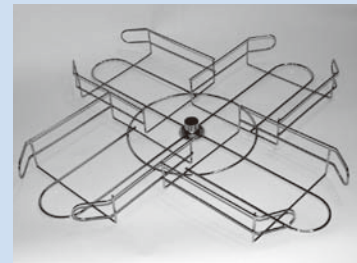

WBCP
4-tier baseball cap spinner

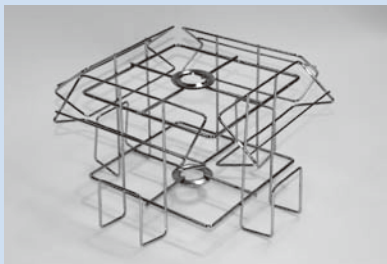

WBDV
4-tier DVD spinner



WBHT
4-tier hat spinner

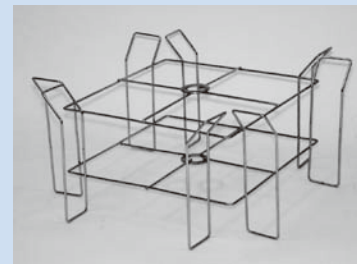

WBLT
4-tier literature spinner

• BT & CS are not available for WB (Wire Base).



63" HIGH FLOOR RACK

Each unit including tubing base, adjustable spinner holder and sign holder.

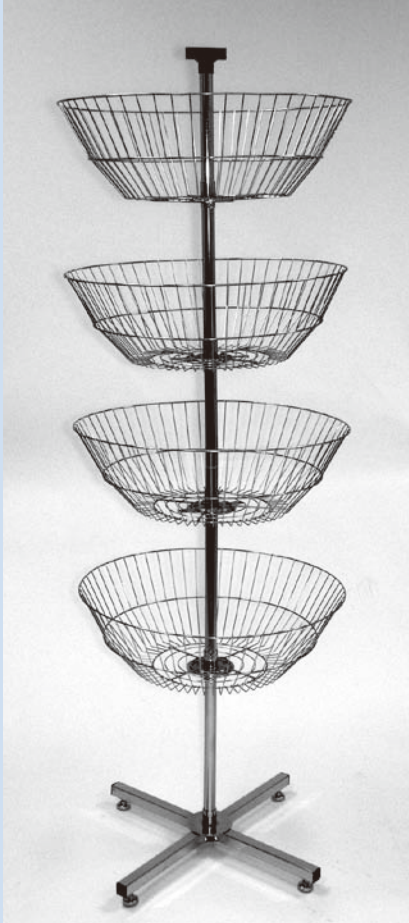

TBBT
(As photo shown, base on applicable components, mix and match for complete spinner unit.)



TB6H
4-tier 6 hook spinner

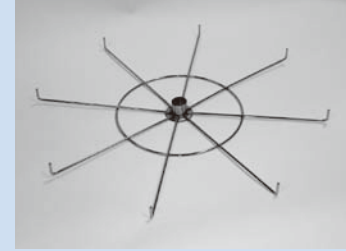

TB8H
4-tier 8 hook spinner



TB10H
4-tier 10 hook spinner



TB12H
4-tier 12 hook spinner



TBBT
4-tier basket spinner



TBCA
4-tier greeting card spinner

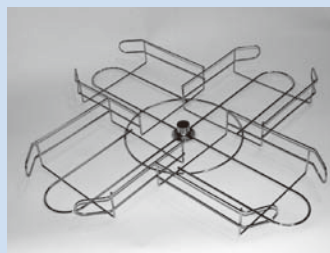

TB3P
4-tier baseball cap spinner



TB3S
6 strand wire clip strip spinner



TBDV
4-tier DVD spinner



TBHT
4-tier hat spinner

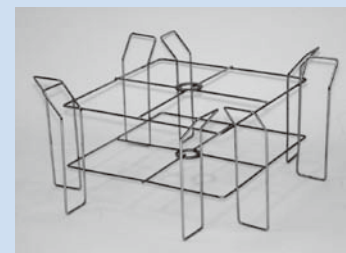

TBLT
4-tier literature spinner



63" HIGH FLOOR RACK

Each unit including 5-claws tubing base with leveler, adjustable spinner holder and sign holder.

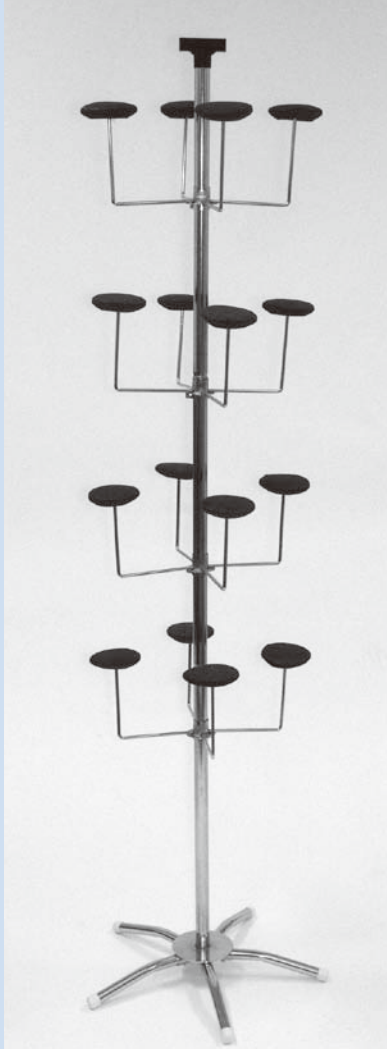

5TBHT
(As photo shown, base on applicable components, mix and match for complete spinner unit.)



5TB6H
4-tier 6 hook spinner



5TB8H
4-tier 8 hook spinner



5TB10H
4-tier 10 hook spinner

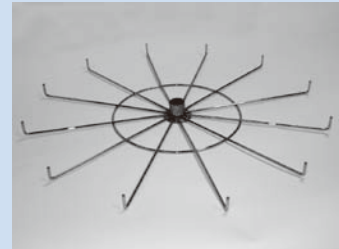

5TB12H
4-tier 12 hook spinner

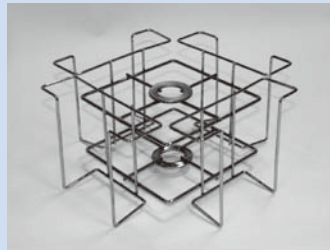

5TBCA
4-tier greeting card spinner

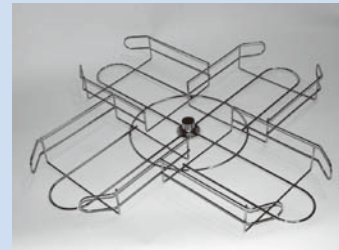

5TBCP
4-tier baseball cap spinner



5TBDV
4-tier DVD spinner



5TBHT
4-tier hat spinner



5BTLT
4-tier literature spinner

• BT & CS are not available for 5TB (5-Claw Tubing Base).

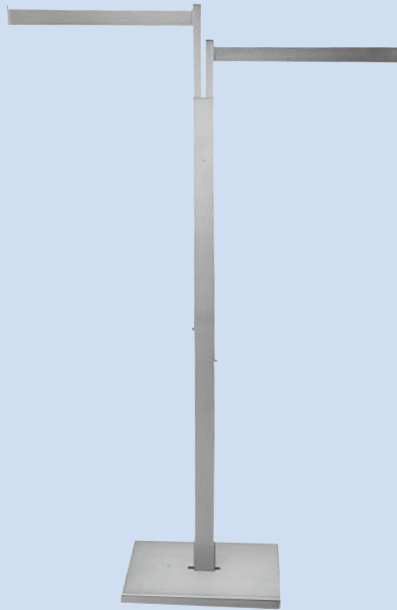

2 ARM RACK

- 2 Straight arms 16"L, made of 1/2" × 1-1/2" rect tubing
- Arms adjust from 48" to 72" every 3"
- Sturdy 12" × 15" weighted base
- Upright made of single 1" × 2" rect tubing
- Satin Chrome

R85-1SC



ADJUSTABLE ROUND RACK

- Hangrail made of 1/2" × 1½" rect tubing
- Adjusts from 48" to 66" every 3"
- Base made of 1" square tubing
- Folds flat for easy storage
- Satin Chrome

RR36-SC 36" Dia

RR42-SC 42" Dia

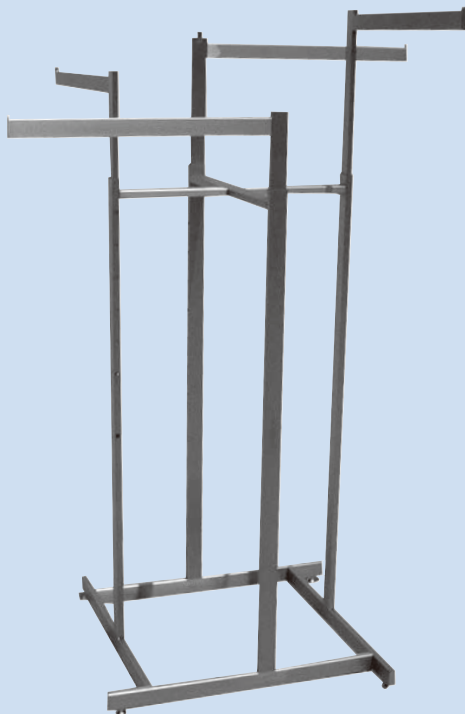

SUPER QUAD 4 ARM RACK

- 4 Straight arms 22"L, made of 1/2" × 1-1/2" rect tubing
- Arms adjust from 48" to 72" every 3"
- Base and frames made of 5/8" × 1-5/8" rect tubing
- 3/8" threaded fitting on 1 arm to accept card frame
- Satin Chrome

RR22C-SC

S



SECURITY DEVICES

CHAPTER	DIVISION	CONTENTS
S	01	SECURITY DEVICES



SIMULATED SECURITY TOWERS



LOOK LIKE THE REAL THING!

Deter would-be shoplifters at a fraction of the cost of an electronic security system.

Elaborately crafted, heavy gauge metal in a neutral finish creates a realistic look.

SECUR2
(non-functioning-no electronics)

SECURITY & SAFETY MIRRORS

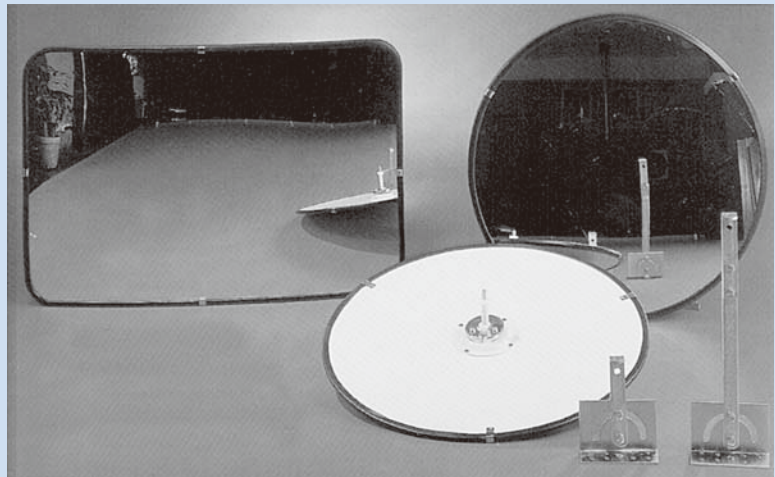

All size of long-life glass convex mirrors for safety and security applications. Ideal for factory, warehouses, shipping docks, hospitals, public buildings, and retail stores.

- Eliminate hazardous "blind spots", avoid costly accidents.
- Safeguard entrances/exits and aisles, prevent theft.
- Long-life, scratch and maintenance free glass material ensure clear view, reduce long-term costs.

BACKING & MOUNTING

All mirrors come with light-weight waterproof plywood backs and shipped complete with heavy-duty adjustable swivels and steel mounting brackets for easy installation.

Item	Sizes
# SM18	18" dia
# SM24	24" dia
# SM30	30" dia
# SM1520	15" × 20"

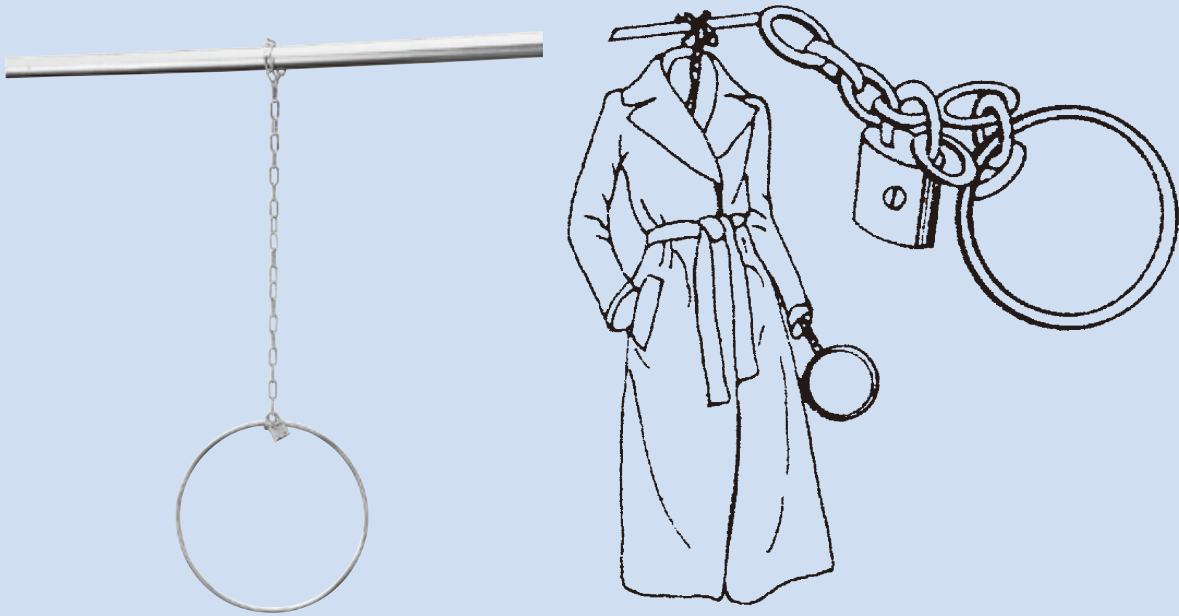

SECURITY CHAIN LOCK

44"L Chain is looped around hangrail, passes through garments sleeve and secured to a large ring, 8" dia. with a lock and 2 keys, nickel finish.

SCL

T

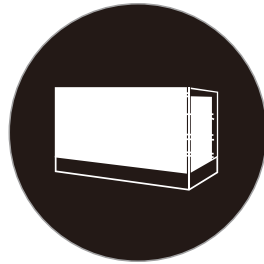

SHOWCASES, COUNTERS, MERCHANTISERS, TABLES, MIRRORS & ETC.

CHAPTER	DIVISION	CONTENTS
T	01	SHOWCASES
	02	TABLES
	03	MIRRORS
	04	SLATWALL MERCHANTISERS
	05	COUNTERS
	06	BASES
	07	SHELVING

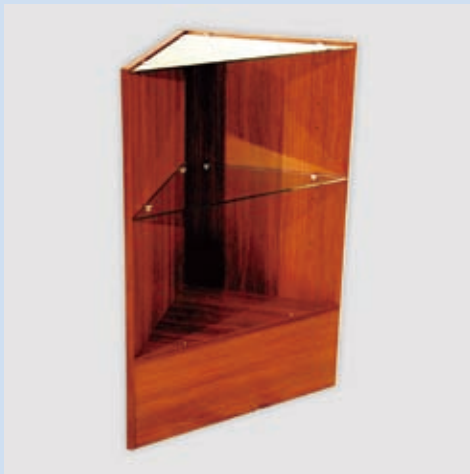

TRIANGULAR CORNER CASE

With Glass Top & Shelf
Size: 18" × 18" × 38"H

Item	Color
# T1-1B	Black
# T1-1CH	Cherry
# T1-1MP	Maple
# T1-1W	White
# T1-1WA	Walnut

- Durable melamine laminate surface
- Two adjustable tempered glass shelves



PENTAGON CORNER CASE

With Glass Top & shelf
Size: 18" × 18" × 38"H

Item	Color
# T1-2B	Black
# T1-2CH	Cherry
# T1-2MP	Maple
# T1-2W	White
# T1-2WA	Walnut

- Durable melamine laminate surface
- Two adjustable tempered glass shelves



JEWELRY CASE

Item	Size	Color
T1-3A-B	48"L × 18"W × 38"H	Black
T1-3A-CH	48"L × 18"W × 38"H	Cherry
T1-3A-MP	48"L × 18"W × 38"H	Maple
T1-3A-W	48"L × 18"W × 38"H	White
T1-3A-WA	48"L × 18"W × 38"H	Walnut
T1-3B-B	60"L × 18"W × 38"H	Black
T1-3B-CH	60"L × 18"W × 38"H	Cherry
T1-3B-MP	60"L × 18"W × 38"H	Maple
T1-3B-W	60"L × 18"W × 38"H	White
T1-3B-WA	60"L × 18"W × 38"H	Walnut
T1-3C-B	70"L × 18"W × 38"H	Black
T1-3C-CH	70"L × 18"W × 38"H	Cherry
T1-3C-MP	70"L × 18"W × 38"H	Maple
T1-3C-W	70"L × 18"W × 38"H	White
T1-3C-WA	70"L × 18"W × 38"H	Walnut

- Durable melamine laminate surface
- All tempered safety glass
- 10" H front viewing area
- Stain finished clear anodized aluminum frame extrusion
- 18" H storage cabin
- Bright white finished hardboard sliding doors



HALF VISION SHOWCASE

Item	Size	Color
T1-4A-B	48"L × 18"W × 38"H	Black
T1-4A-CH	48"L × 18"W × 38"H	Cherry
T1-4A-MP	48"L × 18"W × 38"H	Maple
T1-4A-W	48"L × 18"W × 38"H	White
T1-4A-WA	48"L × 18"W × 38"H	Walnut
T1-4B-B	60"L × 18"W × 38"H	Black
T1-4B-CH	60"L × 18"W × 38"H	Cherry
T1-4B-MP	60"L × 18"W × 38"H	Maple
T1-4B-W	60"L × 18"W × 38"H	White
T1-4B-WA	60"L × 18"W × 38"H	Walnut
T1-4C-B	70"L × 18"W × 38"H	Black
T1-4C-CH	70"L × 18"W × 38"H	Cherry
T1-4C-MP	70"L × 18"W × 38"H	Maple
T1-4C-W	70"L × 18"W × 38"H	White
T1-4C-WA	70"L × 18"W × 38"H	Walnut

- Durable melamine laminate surface
- All tempered safety glass
- 18" H front viewing area
- Adjustable 10" glass shelf
- Stain finished clear anodized aluminum frame extrusion
- Chrome finished standard and bracket
- 10" H storage cabin
- Bright white finished hardboard sliding doors

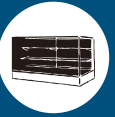

FULL VISION SHOWCASE

Item	Size	Color
T1-5A-B	48"L × 18"W × 38"H	Black
T1-5A-CH	48"L × 18"W × 38"H	Cherry
T1-5A-MP	48"L × 18"W × 38"H	Maple
T1-5A-W	48"L × 18"W × 38"H	White
T1-5A-WA	48"L × 18"W × 38"H	Walnut
T1-5B-B	60"L × 18"W × 38"H	Black
T1-5B-CH	60"L × 18"W × 38"H	Cherry
T1-5B-MP	60"L × 18"W × 38"H	Maple
T1-5B-W	60"L × 18"W × 38"H	White
T1-5B-WA	60"L × 18"W × 38"H	Walnut
T1-5C-B	70"L × 18"W × 38"H	Black
T1-5C-CH	70"L × 18"W × 38"H	Cherry
T1-5C-MP	70"L × 18"W × 38"H	Maple
T1-5C-W	70"L × 18"W × 38"H	White
T1-5C-WA	70"L × 18"W × 38"H	Walnut

- Durable melamine laminate surface
- All tempered safety glass
- 28" H front viewing area
- Adjustable 8" and 10" glass shelves
- Stain finished clear anodized aluminum frame extrusion
- Chrome finished standard and bracket
- Bright white finished hardboard sliding doors

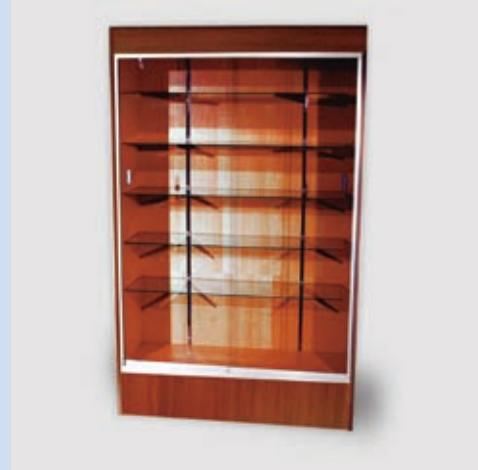

FULLVIEW WALLCASE

Size: 48"L × 18"W × 78"H

Item	Color
# T1-6B	Black
# T1-6CH	Cherry
# T1-6MP	Maple
# T1-6W	White
# T1-6WA	Walnut

- Durable melamine laminate surface
- All tempered safety glass
- 1/4" Glass sliding door
- 67" Vertical display area
- Five adjustable 12" glass shelves
- Stain finished clear anodized aluminum frame extrusion
- Chrome finished standard and bracket
- Color matched back panel



HALFVIEW WALLCASE

Size: 48"L x 18"W x 84"H

Item	Color
# T1-7B	Black
# T1-7CH	Cherry
# T1-7MP	Maple
# T1-7W	White
# T1-7WA	Walnut

- Durable melamine laminate surface
- All tempered safety glass
- 1/4" Glass sliding door
- 48" Vertical display area
- Three adjustable 12" glass shelves
- Two 6"H drawers with metal drawer slide
- Two shelves in storage area
- Stain finished clear anodized aluminum frame extrusion
- Chrome finished standard and bracket
- Color matched back panel



HALFVIEW WALLCASE

Size: 48"L x 18"W x 78"H

Item	Color
# T1-8B	Black
# T1-8CH	Cherry
# T1-8MP	Maple
# T1-8W	White
# T1-8WA	Walnut

- Melamine laminate surface
- All tempered safety glass
- 1/4" Glass sliding door
- 48" Vertical display area
- Three adjustable 12" glass shelves
- Two shelves in storage area
- Stain finished clear anodized aluminum frame extrusion
- Chrome finished standard and bracket
- Color matched back panel



FULL VISION SHOWCASE

Size: 48"L x 18"W x 38"H

Item	Color
# T1-9B	Black
# T1-9CH	Cherry
# T1-9MP	Maple
# T1-9W	White
# T1-9WA	Walnut

- Premium frameless structure
- All 6mm tempered safety glass
- Durable melamine laminate surface
- Two 14" Glass shelves
- Tempered safety glass sliding door
- Stain finished clear anodized aluminum door track extrusion
- 32" Vertical display area



HALF VISION SHOWCASE

Size: 48"L × 18"W × 38"H

Item	Color
# T1-10B	Black
# T1-10CH	Cherry
# T1-10MP	Maple
# T1-10W	White
# T1-10WA	Walnut

- Premium frameless structure
- All 6mm tempered safety glass
- Durable melamine laminate surface
- 14" Glass shelf
- Tempered safety glass sliding door
- Stain finished clear anodized aluminum door track extrusion
- 22" Vertical display area
- 10"H storage cabin



TOWER CASE

Size: 20"L × 18"W × 72"H

Item	Color
# T1-11B	Black
# T1-11CH	Cherry
# T1-11MP	Maple
# T1-11W	White
# T1-11WA	Walnut

- Premium frameless structure
- All 6mm tempered safety glass
- Durable melamine laminate surface
- Two 14" Glass shelves
- Tempered safety glass sliding door
- Stain finished clear anodized aluminum door track extrusion
- 34" Vertical display area
- 32"H storage cabin

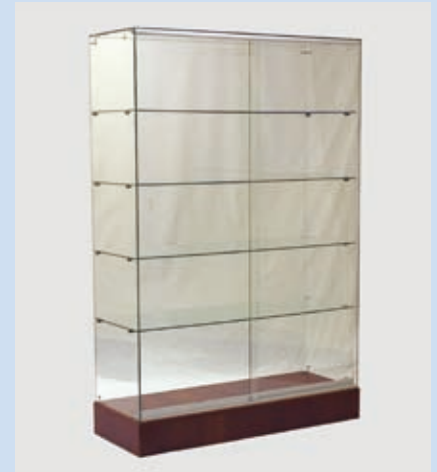

FULL VISION WALLCASE

Size: 48"L × 18"W × 72"H

Item	Color
# T1-12B	Black
# T1-12CH	Cherry
# T1-12MP	Maple
# T1-12W	White
# T1-12WA	Walnut

- Premium frameless structure
- All 6mm tempered safety glass
- Durable melamine laminate surface
- Four 14" Glass shelves
- Tempered safety glass sliding door
- Stain finished clear anodized aluminum door track extrusion
- 66" Vertical display area

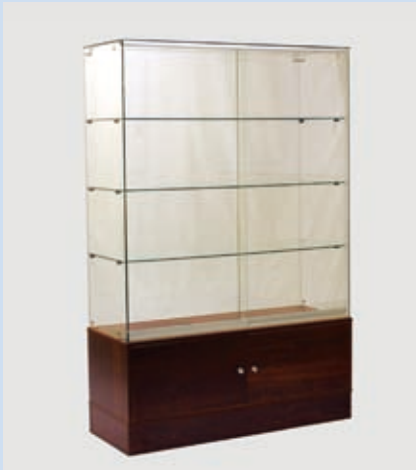
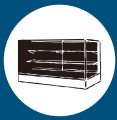

HALF VISION WALLCASE

Size: 48"L x 18"W x 72"H

Item	Color
# T1-13B	Black
# T1-13CH	Cherry
# T1-13MP	Maple
# T1-13W	White
# T1-13WA	Walnut

- Premium frameless structure
- All 6mm tempered safety glass
- Durable melamine laminate surface
- Three 14" Glass shelves
- Tempered safety glass sliding door
- Stain finished clear anodized aluminum door track extrusion
- 52" Vertical display area
- 14"H storage cabin



EXTRA VISION SHOWCASE

Item	Size
# T1-14A	48"L x 20"W x 38"H
# T1-14B	60"L x 20"W x 38"H
# T1-14C	70"L x 20"W x 38"H

- Durable melamine laminate surface
- All tempered safety glass
- 34" H front viewing area
- Adjustable 10" and 12" glass shelves
- Stain finished clear anodized aluminum frame extrusion
- Chrome finished standard and bracket
- Aluminum corner base protectors
- Bright white finished hardboard sliding doors



WALLCASE

Size: 48"L x 20"W x 72"H

Item	Color
# T1-15A-B	Black
# T1-15A-CH	Cherry
# T1-15A-MP	Maple
# T1-15A-W	White
# T1-15A-WA	Walnut

Size: 70"L x 20"W x 72"H

Item	Color
# T1-15B-B	Black
# T1-15B-CH	Cherry
# T1-15B-MP	Maple
# T1-15B-W	White
# T1-15B-WA	Walnut

- All tempered safety glass
- 1/4" Glass sliding door
- 60" Vertical display area
- Four adjustable 12" glass shelves
- Stain finished clear anodized aluminum frame extrusion
- 1" Square heavy duty chrome finished standard and brackets
- Aluminum corner base protectors

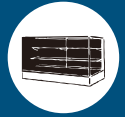

EXTRA VISION CORNER CASE

Item	Size
# T1-16	42" × 42" × 38"H

- Durable melamine laminate surface
- All tempered safety glass
- 34" H front viewing area
- Adjustable 10" and 12" glass shelves
- Stain finished clear anodized aluminum frame extrusion
- Chrome finished standard and bracket
- Aluminum corner base protectors
- Bright white finished hardboard sliding doors



DISPLAY TOWERCASE

Item	Size
# T1-17	20"L × 20"W × 72"H

- Durable melamine laminate surface
- All tempered safety glass
- 60" Vertical display area
- Four adjustable glass shelves
- Stain finished clear anodized aluminum frame extrusion
- Aluminum corner base protectors
- Front swing door with lock



LOCKS

Showcase Accessories

Item	Description
# SCLKP	Plunger lock
# SCLKS	Ratchet lock



T5 FLUORESCENT LIGHT

Item	Description
# SCLT5-4	FOR 48" L SHOWCASE
# SCLT5-5	FOR 60" L SHOWCASE
# SCLT5-6	FOR 70" L SHOWCASE

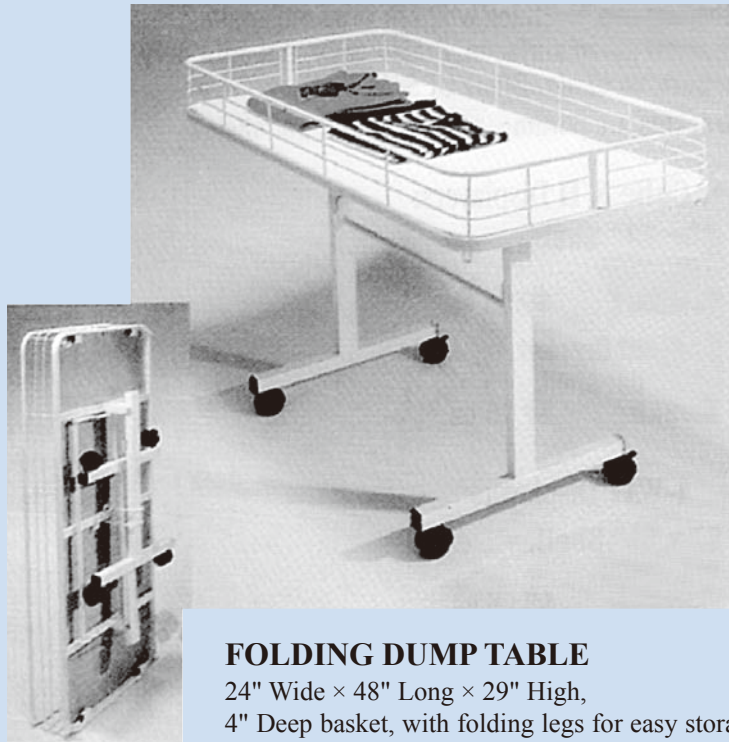

FOLDING DUMP TABLE

24" Wide × 48" Long × 29" High,
4" Deep basket, with folding legs for easy storage.
Folds to only 9" thick.
4 pcs. plastic casters included.

- # FPT Chrome
- # FPT-B Black
- # FPT-W White

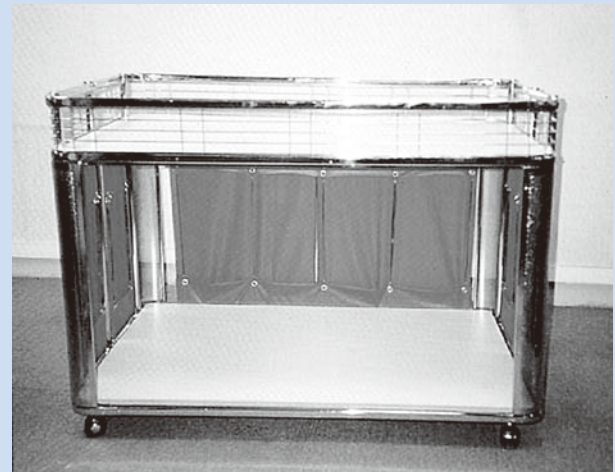

FOLDING DUMP TABLE

30" Wide × 48" Long × 34" High with canvas,
4 pcs. plastic casters included, chrome finish.
FDT



3 TIER DISPLAY TABLE - RECTANGULAR SHAPE

Size: 60"L x 42"W x 42"H

Item	Color
# T2-1B	Black
# T2-1CH	Cherry
# T2-1MP	Maple
# T2-1W	White
# T2-1WA	Walnut

- Durable melamine laminate surface
- Rectangular with square corners
- Top tier : 18" x 52"
- Middle tier : 34" x 60"
- Bottom tier : 42" x 60"
- Thickness: 1-1/2"



3 TIER DISPLAY TABLE - SQUARE SHAPE

Size: 48"L x 48"W x 42"H

Item	Color
# T2-2B	Black
# T2-2CH	Cherry
# T2-2MP	Maple
# T2-2W	White
# T2-2WA	Walnut

- Durable melamine laminate surface
- Square with 2" radius corners
- Top tier : 24" x 24"
- Middle tier : 36" x 36"
- Bottom tier : 48" x 48"
- Thickness: 1-1/2"



3 TIER DISPLAY TABLE - OVAL SHAPE

Size: 60"L x 42"W x 42"H

Item	Color
# T2-3B	Black
# T2-3CH	Cherry
# T2-3MP	Maple
# T2-3W	White
# T2-3WA	Walnut

- Durable melamine laminate surface
- Top tier : 18" x 52"
- Middle tier : 34" x 60"
- Bottom tier : 42" x 60"
- Thickness: 1-1/2"

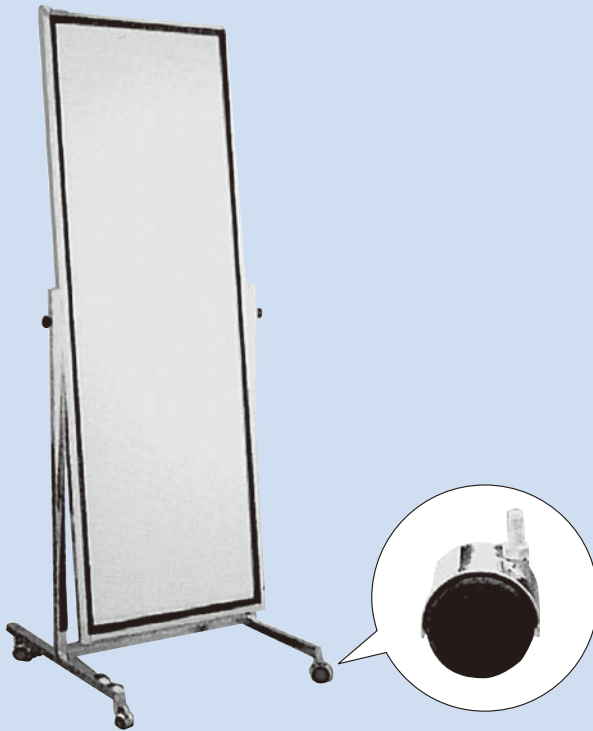
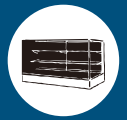

ADJUSTABLE TILT SINGLE MIRROR

Measures 20"W x 60"H
 Framed with 1" square tubing.
 4-pc. Twin wheel casters included
 # TSM Chrome
 # TSM-B Black

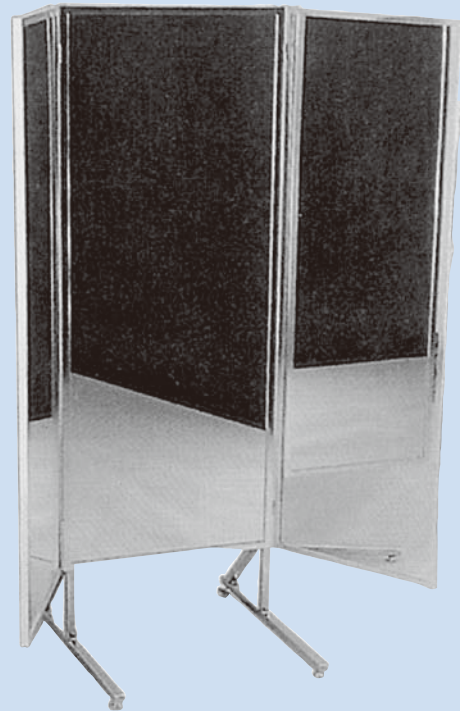

3-WAY MIRROR

Center panel is 20"W x 60"H,
 Wing panels are 18"W x 60"H,
 Over height of free-standing unit is 72",
 with chrome stand.
 # CM3W-S



CHROME DISTORTION FREE SHOE MIRROR

Plate glass mirror measures
 12" x 1/4" x 18"
 Rectangular tube frame.
 #SM

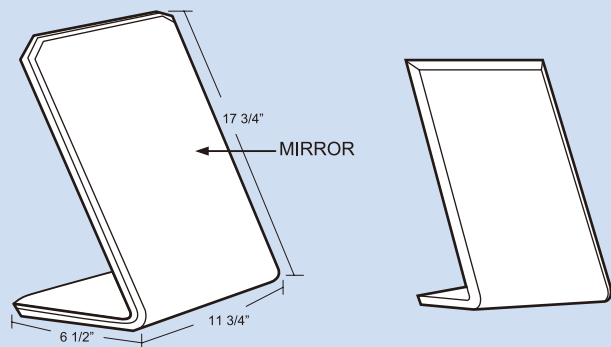

ACRYLIC SHOE FITTING MIRROR

With beveled & polished edges
 Size 11-3/4" x 17-3/4"
 # 226-1092



WOOD CLOTH MIRROR

Frame in walnut color
Adjustable tilt single mirror
Measures 20"W × 60"H
4-pc. Black twin wheel casters included.
2 locking & 2 non-locking
WCM-WA



WOOD SHOE MIRROR

Frame in walnut color
Single mirror
Measures 12"W × 22"H
Foldable for easy storage
WSM-WA

**SLATWALL 4-WAY DISPLAY**

Item	Color
# T4-1B	Black
# T4-1CH	Cherry
# T4-1MP	Maple
# T4-1W	White
# T4-1WA	Walnut

- Overall size
36" D × 36" W × 54" H
including 6" base
- Four center slatwall panels
24" W × 48" H

**SLATWALL CUBIC TOWER**

With Rotating Function

Item	Color
# T4-2B	Black
# T4-2CH	Cherry
# T4-2MP	Maple
# T4-2W	White
# T4-2WA	Walnut

- Overall size
20" D × 20" W × 54" H
including 6" base
- Four center slatwall panels
20" W × 48" H

**SLATWALL 2-WAY DISPLAY**

Item	Color
# T4-3B	Black
# T4-3CH	Cherry
# T4-3MP	Maple
# T4-3W	White
# T4-3WA	Walnut

- Overall size
24" D × 25-1/2" W × 54" H
including 6" base
- Center slatwall panels
24" W × 48" H
- Two side panels
6" W × 48" H



SLATWALL 4FT H UNIT

Item	Color
# T4-4B	Black
# T4-4CH	Cherry
# T4-4MP	Maple
# T4-4W	White
# T4-4WA	Walnut

- Overall size
24" D × 49-1/2" W × 54" H
including 6" base
- Center slatwall panels
48" W × 48" H
- Two side panels
24" W × 48" H



SLATWALL 2FT H UNIT

Item	Color
# T4-5B	Black
# T4-5CH	Cherry
# T4-5MP	Maple
# T4-5W	White
# T4-5WA	Walnut

- Overall size
24" D × 25-1/2" W × 54" H
including 6" base
- Center slatwall panels
24" W × 48" H
- Two side panels
24" W × 48" H



LEDGETOP COUNTER

Item	Size	Color
T5-1A-B	48"L × 22"W × 42"H	Black
T5-1A-CH	48"L × 22"W × 42"H	Cherry
T5-1A-MP	48"L × 22"W × 42"H	Maple
T5-1A-W	48"L × 22"W × 42"H	White
T5-1A-WA	48"L × 22"W × 42"H	Walnut
T5-1C-B	72"L × 22"W × 42"H	Black
T5-1C-CH	72"L × 22"W × 42"H	Cherry
T5-1C-MP	72"L × 22"W × 42"H	Maple
T5-1C-W	72"L × 22"W × 42"H	White
T5-1C-WA	72"L × 22"W × 42"H	Walnut

- Durable melamine laminate surface
- 9" Wide check writing table
- 18" Wide body with 22" wide top
- 6"H drawer with metal drawer slide
- Two adjustable storage shelves
- 2" dia. hole on the top left side of counter with plastic cap.



WRAP COUNTER

Item	Size	Color
T5-2A-B	48"L × 20"W × 38"H	Black
T5-2A-CH	48"L × 20"W × 38"H	Cherry
T5-2A-MP	48"L × 20"W × 38"H	Maple
T5-2A-W	48"L × 20"W × 38"H	White
T5-2A-WA	48"L × 20"W × 38"H	Walnut
T5-2B-B	60"L × 20"W × 38"H	Black
T5-2B-CH	60"L × 20"W × 38"H	Cherry
T5-2B-MP	60"L × 20"W × 38"H	Maple
T5-2B-W	60"L × 20"W × 38"H	White
T5-2B-WA	60"L × 20"W × 38"H	Walnut
T5-2C-B	70"L × 20"W × 38"H	Black
T5-2C-CH	70"L × 20"W × 38"H	Cherry
T5-2C-MP	70"L × 20"W × 38"H	Maple
T5-2C-W	70"L × 20"W × 38"H	White
T5-2C-WA	70"L × 20"W × 38"H	Walnut

- Durable melamine laminate surface
- 18" Wide body with 20" wide top
- Three adjustable storage shelves



CASH REGISTER STAND

Size: 24"L x 18"W x 38"H

Item	Color
# T5-3B	Black
# T5-3CH	Cherry
# T5-3MP	Maple
# T5-3W	White
# T5-3WA	Walnut

- Durable melamine laminate surface
- 4" H drawer with metal drawer slide
- Adjustable storage shelf
- 2" dia. hole on the top left side of stand with plastic cap.



GLASS FRONT CASH REGISTER STAND

Size: 24"L x 18"W x 38"H

Item	Color
# T5-4B	Black
# T5-4CH	Cherry
# T5-4MP	Maple
# T5-4W	White
# T5-4WA	Walnut

- Durable melamine laminate surface
- 24" H glass front display area
- One 15" adjustable glass shelf
- Bright white rear access sliding doors
- Rear 6" storage cabin

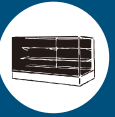
**SQUARE BASE**

Item	Size	Color
# T6-1A-B	14"L × 14"W × 12"H	Black
# T6-1A-CH	14"L × 14"W × 12"H	Cherry
# T6-1A-MP	14"L × 14"W × 12"H	Maple
# T6-1A-W	14"L × 14"W × 12"H	White
# T6-1A-WA	14"L × 14"W × 12"H	Walnut
# T6-1B-B	16"L × 16"W × 12"H	Black
# T6-1B-CH	16"L × 16"W × 12"H	Cherry
# T6-1B-MP	16"L × 16"W × 12"H	Maple
# T6-1B-W	16"L × 16"W × 12"H	White
# T6-1B-WA	16"L × 16"W × 12"H	Walnut

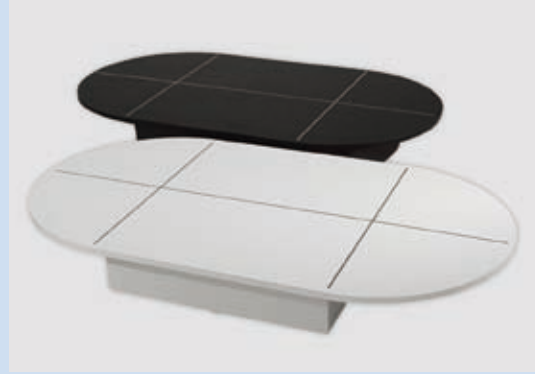
**OVAL BASE**

Size: 54"L × 30"W × 6"H

Item	Color
# T6-3B	Black
# T6-3CH	Cherry
# T6-3MP	Maple
# T6-3W	White
# T6-3WA	Walnut

**ROUND REVOLVING BASE**

Size: 30"Dia.

Item	Color
# T6-2B	Black
# T6-2CH	Cherry
# T6-2MP	Maple
# T6-2W	White
# T6-2WA	Walnut

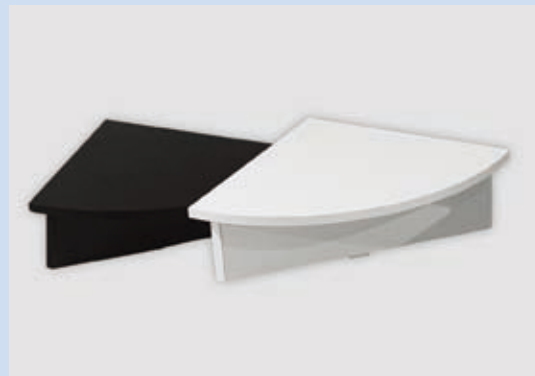
**QUARTER ROUND BASE**

Size: 17"L × 17"W × 6"H

Item	Color
# T6-4B	Black
# T6-4CH	Cherry
# T6-4MP	Maple
# T6-4W	White
# T6-4WA	Walnut

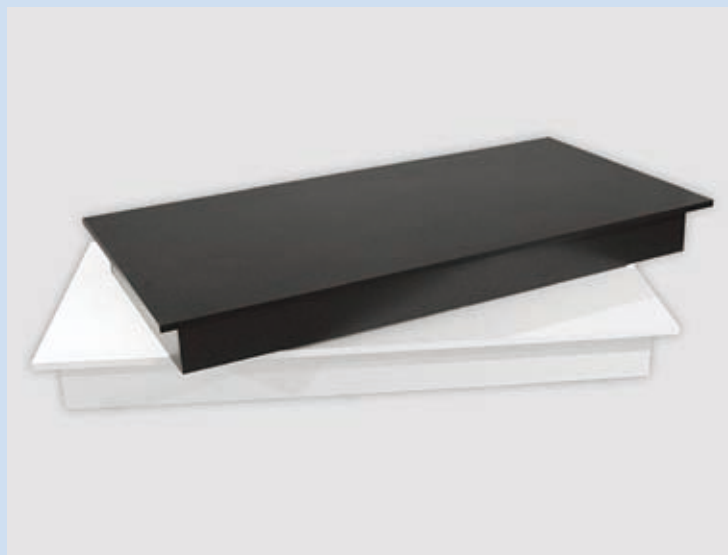
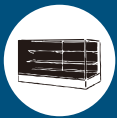

RECTANGULAR BASE

Item	Size	Color
# T6-5A-B	48"L × 30"W × 6"H	Black
# T6-5A-CH	48"L × 30"W × 6"H	Cherry
# T6-5A-MP	48"L × 30"W × 6"H	Maple
# T6-5A-W	48"L × 30"W × 6"H	White
# T6-5A-WA	48"L × 30"W × 6"H	Walnut
# T6-5B-B	60"L × 30"W × 6"H	Black
# T6-5B-CH	60"L × 30"W × 6"H	Cherry
# T6-5B-MP	60"L × 30"W × 6"H	Maple
# T6-5B-W	60"L × 30"W × 6"H	White
# T6-5B-WA	60"L × 30"W × 6"H	Walnut
# T6-5C-B	70"L × 16"W × 6"H	Black
# T6-5C-CH	70"L × 16"W × 6"H	Cherry
# T6-5C-MP	70"L × 16"W × 6"H	Maple
# T6-5C-W	70"L × 16"W × 6"H	White
# T6-5C-WA	70"L × 16"W × 6"H	Walnut

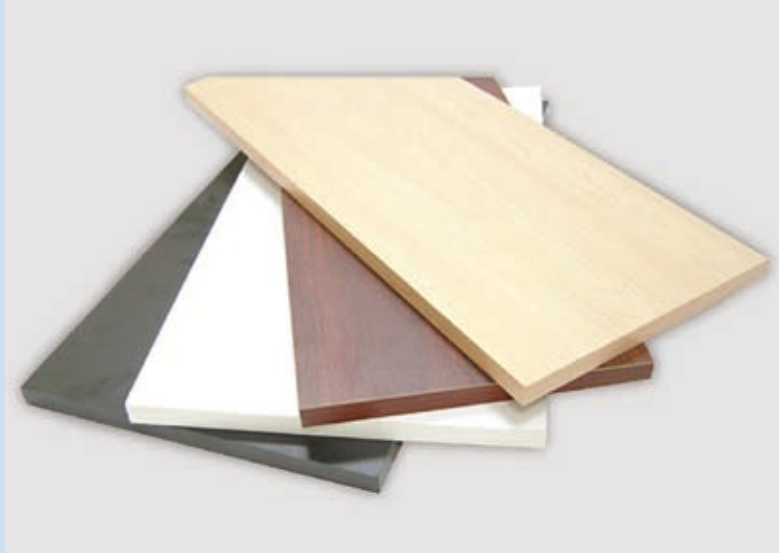

MELAMINE WOOD SHELVING

Item	Size	Color
# WS1024B	10" × 24"	Black
# WS1024CH	10" × 24"	Cherry
# WS1024MP	10" × 24"	Maple
# WS1024W	10" × 24"	White
# WS1024WA	10" × 24"	Walnut
# WS1048B	10" × 48"	Black
# WS1048CH	10" × 48"	Cherry
# WS1048MP	10" × 48"	Maple
# WS1048W	10" × 48"	White
# WS1048WA	10" × 48"	Walnut
# WS1224B	12" × 24"	Black
# WS1224CH	12" × 24"	Cherry
# WS1224MP	12" × 24"	Maple
# WS1224W	12" × 24"	White
# WS1224WA	12" × 24"	Walnut
# WS1248B	12" × 48"	Black
# WS1248CH	12" × 48"	Cherry
# WS1248MP	12" × 48"	Maple
# WS1248W	12" × 48"	White
# WS1248WA	12" × 48"	Walnut

- 3/4" Thickness melamine laminated
- Bracket sold separately

U

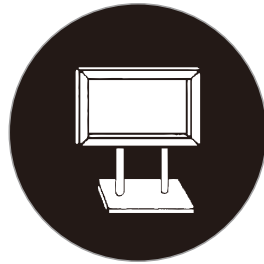

SIGNHOLDERS

CHAPTER	DIVISION	CONTENTS
U	01	ACRYLIC
	02	BULLETIN
	03	CLAMP & STEM
	04	EASEL
	05	MAGNETIC
	06	MITRED CORNER
	07	ROUND CORNER
	08	BANNER STAND
	09	ALLIGATOR CLIP

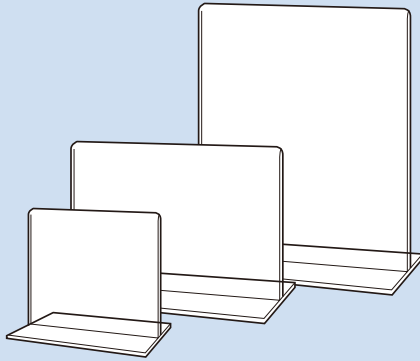

**ACRYLIC BOTTOM
LOADING SIGN HOLDER**

Two Sided Self Standing

ITEM	H	×	W
# PG35	3½"	×	5"
# PG57	5½"	×	7"
# PG711	7"	×	11"
# PG811	8½"	×	11"
# PG35V	5"	×	3½"
# PG57V	7"	×	5½"
# PG711V	11"	×	7"
# PG811V	11"	×	8½"
# PG114V	14"	×	11"

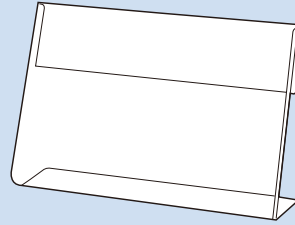

**ACRYLIC SIGN
HOLDER**

Slant Self Standing

ITEM	H	×	W
# PH57	5½"	×	7"
# PH711	7"	×	11"

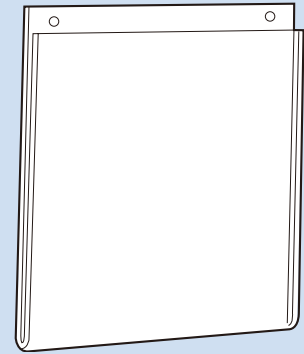

**SCREW MOUNT OR
HANGING SIGN HOLDER**

Made of clear acrylic.
Edge finished and polished.

ITEM	H	×	W
# JD506	7"	×	5½"
# JD507	5½"	×	7"
# JD508	11"	×	7"
# JD509	7"	×	11"
# JD512	14"	×	11"
# JD513	11"	×	14"

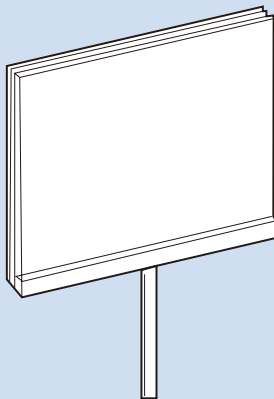

**ACRYLIC SIGN
HOLDER**

with 3"L Swedge Stem

ITEM	H	×	W
# PJ57X	5½"	×	7"
# PJ711X	7"	×	11"

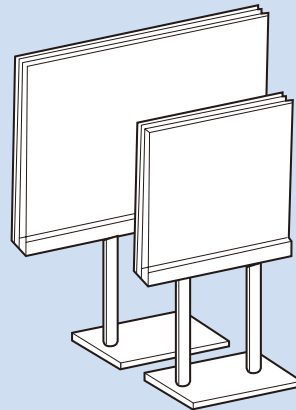

ACRYLIC SIGN HOLDER

Twin 4" Post with felt bottom
(Chrome channel 3½" × 5" base.)

ITEM	H	×	W
# SAP57	5½"	×	7"
# SAP711	7"	×	11"
# SAP57V	7"	×	5½"

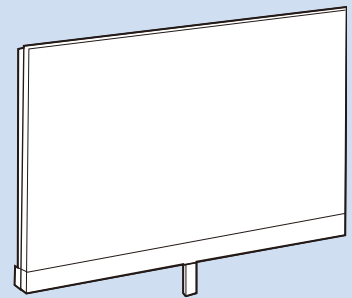

ACRYLIC SIGN HOLDER

with Chrome Channel
(Accepts ¼" or ⅜" stems.)

ITEM	H	×	W
# SA57	5½"	×	7"
# SA711	7"	×	11"
# SA711V	11"	×	7"



ACRYLIC ECONOMY BOTTOM LOADING SIGN HOLDER

With 2-sided sign holder, 1/16" thick.

ITEM	H	×	W
# AC-8151	5½"	×	3½"
# AC-8152	3½"	×	5½"
# AC-8160	5½"	×	7"

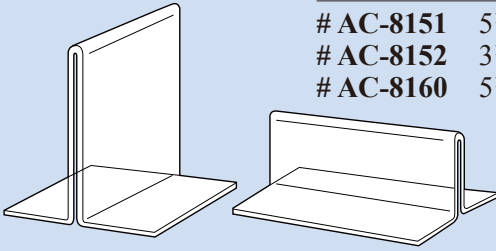

ACRYLIC TOP LOADING SIGN HOLDER

ITEM	H	×	W
# TL35H	3½"	×	5½"
# TL57H	5½"	×	7"
# TL711H	7"	×	11"
# TL114H	11"	×	14"
# TL811V	11"	×	8½"
# TL114V	14"	×	11"

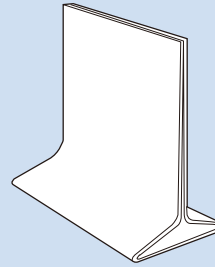

ACRYLIC ECONOMY SLANT BACK SIGN HOLDER

1/16" thick.

ITEM	H	×	W
# AC-8101	5½"	×	3½"

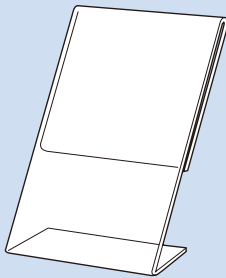

ACRYLIC SIGN HOLDER

Slant Self Standing

ITEM	H	×	W
# PH57V	7"	×	5½"
# PH711V	11"	×	7"
# PH811V	11"	×	8½"

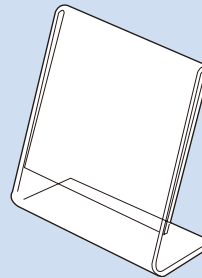

ACRYLIC SIGN HOLDER WITH LITERATURE POCKET

Holds 13"W × 11"H sign and dispenses 4"W × 9"H literature, 1-1/2" deep pocket with 4" lip, 1/8" thick.

ITEM	H	×	W
# AC-1086	11"	×	13½"

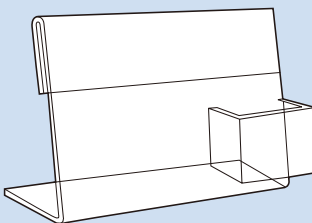

ACRYLIC SIGN HOLDER

Slant Self Standing

ITEM	H	×	W
# SH1411	14"	×	11"

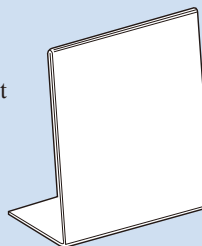

ACRYLIC ECONOMY SIGN HOLDER

For Slatwall, 1/16" thick.

ITEM	H	×	W
# AC-8029	5½"	×	3½"
# AC-8030	3½"	×	5½"
# AC-8032	5½"	×	7"

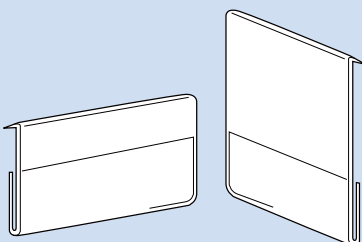

SIGN CLIP W/MOUNTING CLAMP

Sign clip 3-1/8" wide, Overall height 4-1/8" H, Clamp fits up to 1-1/4" round, square or rectangular tubing.

- # WB-48 Clear
- # WB-48B Black
- # WB-48W White

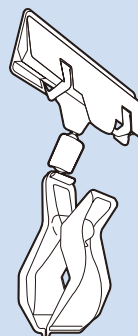



Polished Chrome

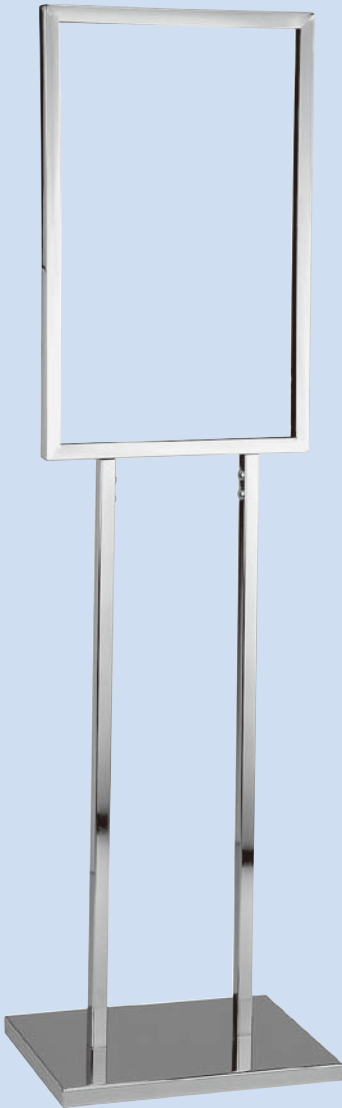

14" × 22" SIGN HOLDER
on two 7/8" square uprights -
extra heavy weighted base
12" × 15". Height is 54", chrome
BUSQ22



14" × 22" SIGN HOLDER
on two 31" round uprights with
10" × 14" heavy base. Height is
53", chrome
BURD22

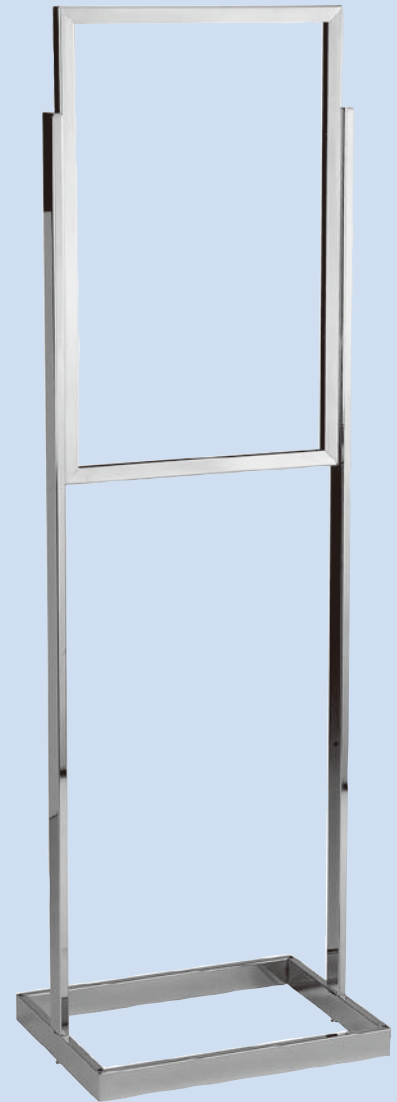

14" × 22" SIGN HOLDER
Vertical frame and base are
made of rectangular tubing
1/2" × 1 1/2". Base 12" × 16".
Height is 53", chrome
BURT22

22" × 28" SIGN HOLDER
on two 7/8" square uprights -
extra heavy weighted base
15" × 20". Height is 60", chrome
BUSQ28

22" × 28" SIGN HOLDER
on two 31" round uprights with
10" × 14" heavy base. Height is
59", chrome
BURD28

22" × 28" SIGN HOLDER
Vertical frame and base are
made of rectangular tubing
1/2" × 1 1/2". Base 15" × 23 1/2".
Height is 56", chrome
BURT28

Same As # BURD28
but Matte Black
BURD28-MB

Same As # BURT28
but Matte Black
BURT28-MB



22" × 28" DOUBLE BULLETIN SIGN HOLDER

Constructed of 5/8" × 1-5/8"
Rectangular tubing
base is 15" × 24"
height is 60"

DBU Chrome
DBU-B Black

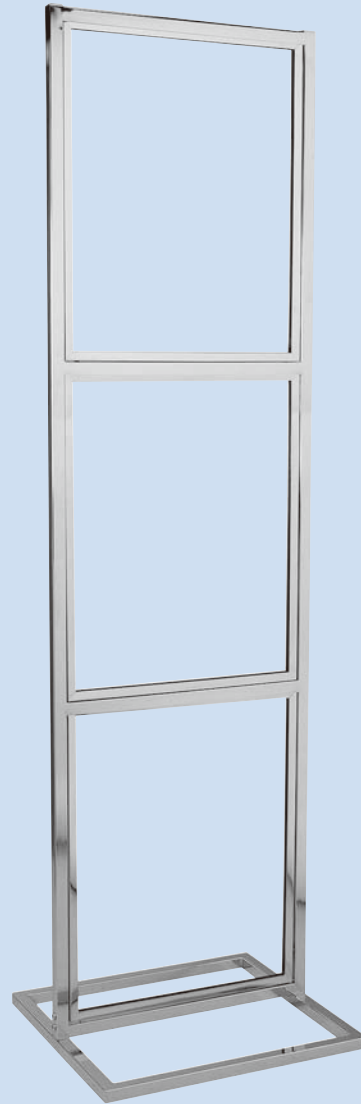

22" × 28" TRIPLE BULLETIN SIGN HOLDER

Constructed of 1-1/4"
square tubing
base is 24" × 25"
height is 90"

TBU Chrome
TBU-B Black

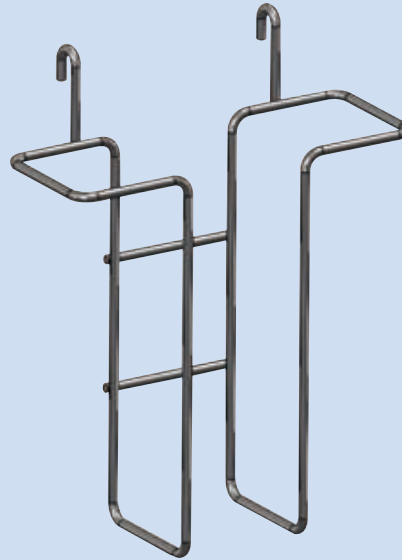
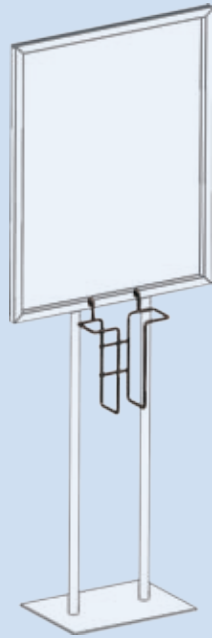

LITERATURE TRAY(Vertical)

9"W × 9"H × 4"D

U2-1 Chrome

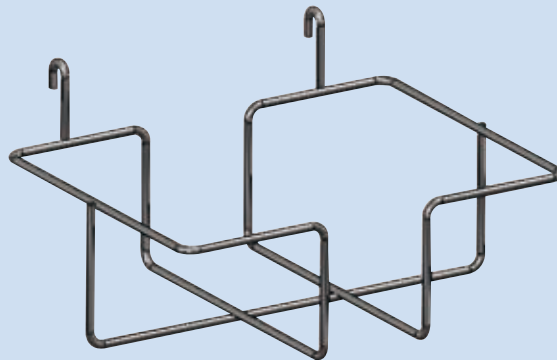
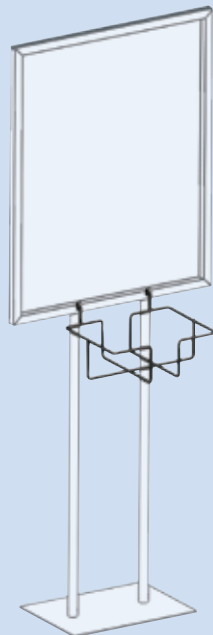

LITERATURE TRAY(Horizontal)

12"W × 4"H × 9"D

U2-2 Chrome



POLISHED CHROME



Universal Clamp
Fits 1" and 1-1/4" round,
1" square, and 1/2" x 1-1/2"
rectangular tubing
CL22



Square Tubing Clamp
Fits 1" square tubing
with 3/8" x 3" stem
CL5



Square Tubing Clamp
Fits 3/4" & 7/8" square
tubing with 3/8" x 3" stem
CL7

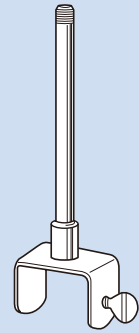

Square Tubing Clamp
Fits 1-1/4" square tubing
with 3/8" x 3-1/2" stem
SC9



**Rectangular Tubing
Clamp**
Fits 1/2" x 1-1/2"
rectangular tubing
with 3/8" x 3" stem
CL6



"0" Clamp With Stem
Fits 1" and 1-1/16"
with 3/8" x 3" stem
CL1
Fits 1-1/4" and 1-5/16"
with 3/8" x 3" stem
CL2



Die Cast "C" Clamp With Stem
Fits 1" and 1-1/16" O.D. tubing
with 3/8" x 3" stem
CC3
Fits 1-1/4" and 1-5/16" O.D.
tubing - with 3/8" x 3" stem
CC4



Square Tubing Clamp
Fits 1" square tubing with
5/8" fitting (Heavy Duty)
CL16



Spring Clamp
Fits 1" square tubing
with 3/8" fitting
CL8

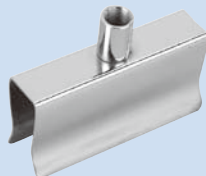

Spring Clamp
Fits 1/2" x 1-1/2"
rectangular tubing
with 3/8" fitting
CL11



Spring Clamp
Fits 1" x 3/16" crossbar
with 3/8" fitting
CL12

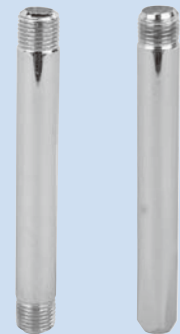

Threaded Stem		Swaged Stem	
3/8" Dia. rod			
Item	Size	Item	Size
# THR3	3"	# SWE3	3"
# THR6	6"	# SWE6	6"
# THR9	9"	# SWE9	9"
# THR12	12"	# SWE12	12"

Card Frame Attachments
For mounting to slotted standards

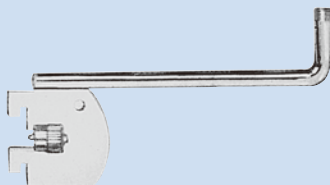

TS-4 5 inches - 3/8" thread
TS-13 12 inches - 3/8" thread

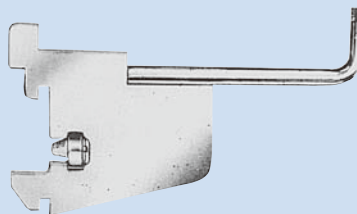

TR-4
Heavy Duty 4 inches 3/8" thread
TR-13
Heavy Duty 11 inches 3/8" thread



Horizontal Stems
3/8" dia rod

Item	Size
# M5A	5"
# M11A	11"

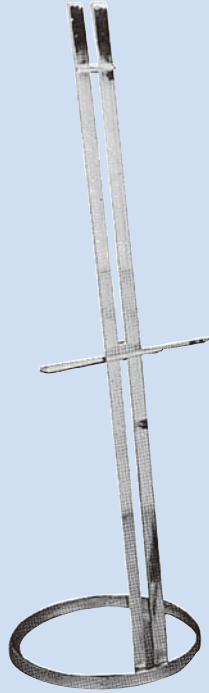

RECTANGULAR TUBE EASEL WITH ROUND BASE

Round base rectangular tube easel with adjustable bottom sign support. Polished chrome $\frac{1}{2}$ " \times $1\frac{1}{2}$ " tubing. Base measures 20" in diameter, uprights are 68" tall.

RB-1

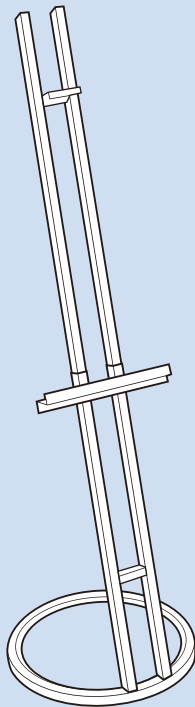

SQUARE TUBE EASEL WITH ROUND BASE

67" high. 20" round base. Bottom edge adjusts from 10" (for 57" sign) down to 56" (for 11" sign). All mirror chrome polished 1" sq. tubing.

CB-1



RECTANGULAR TUBE EASEL WITH FOLDING BACK LEG

Polished chrome $\frac{1}{2}$ " \times $1\frac{1}{2}$ " rectangular tubing with folding back leg. Fixed position card support at 25" from floor. Overall height is 58".

RE-1



SQUARE TUBE EASEL WITH FOLDING BACK LEG

One inch square tube easel measures 60" tall with fixed position card support at 16" from floor. Folding back leg. Polished chrome finish.

CE-1



U4-1G
SLANT TYPE WOOD POSTER STAND,
GOLD FINISH.
Size: 22"W × 35"D × 55"H



U4-1S
SLANT TYPE WOOD POSTER STAND,
SILVER FINISH.
Size: 22"W × 35"D × 55"H



MAGNETIZED MITERED CORNER CARD FRAMES
POLISHED CHROME

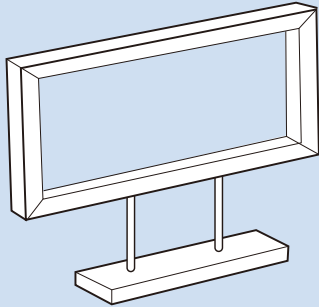

SPP711-CM6
7" × 11" with twin 4" posts
on 6"L. magnetic base.

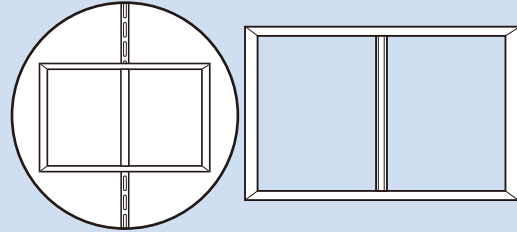

WITH BACK MAGNET
MCK57 5-1/2" × 7"
MCK711 7" × 11"



WITH BOTTOM MAGNET
MCB57 5-1/2" × 7"
MCB711 7" × 11"

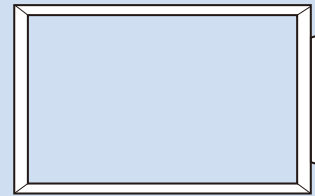

WITH SIDE MAGNET
MCM57 5-1/2" × 7"
MCM711 7" × 11"

MAGNETIZED ACRYLIC CARD HOLDERS



**ACRYLIC CARD
HOLDER**
in chrome channel with bottom
magnet.
SAM57 5-1/2" × 7"
SAM711 7" × 11"

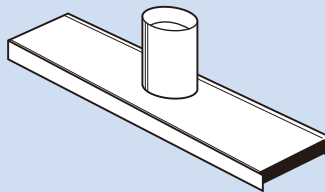

**MAGNETIC SIGN
HOLDER BASE**
threaded base accepts 3/8" fixed
or adjustable stems, Chromed
CM3 3"L
CM4 4"L
CM6 6"L

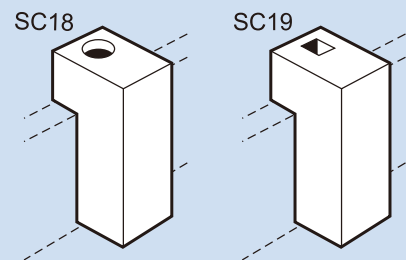

MAGNETIC CLAMP
Great for 2 arm or 4 arm racks
SC18 for 3/8" threaded stem
SC19 for 3/8" swedged stem



CHROMED



PICTURE FRAME SIGN HOLDER

Fits 1/4" and 3/8" stems

- # SP57 5 1/2" x 7"
- # SP711 7" x 11"
- # SP114 11" x 14"

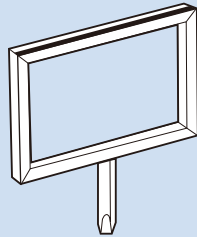

SIGN HOLDER

With 3" swedged stem

- # MC57X 5 1/2" x 7"
- # MC711X 7" x 11"

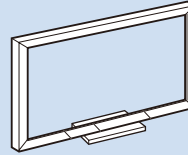

SIGN HOLDER

On Flat Base with felt bottom

- # MCF57 5 1/2" x 7"
- # MCF711 7" x 11"
- # MCF114 11" x 14"

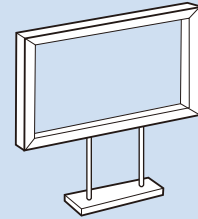

SIGN HOLDER

Twin 4" Posts on Heavy Base with felt bottom

- # SPP57 5 1/2" x 7"
- # SPP711 7" x 11"
- # SPP114 11" x 14"

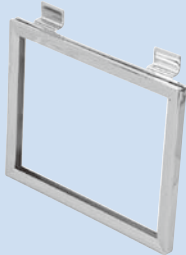

SLATWALL SIGN HOLDER

Signholder mounts on slatwall

- # MSW57 5 1/2" x 7"
- # MSW711 7" x 11"

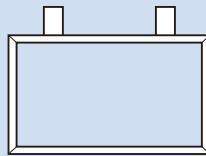

SIGN HOLDER

with tabs for mounting to soffit or cornice.

- # MCS57 5 1/2" x 7"
- # MCS711 7" x 11"

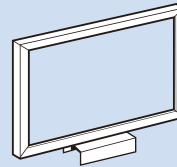

SIGN HOLDER

mounts on 1" square tubing

- # MCT57 5 1/2" x 7"
- # MCT711 7" x 11"

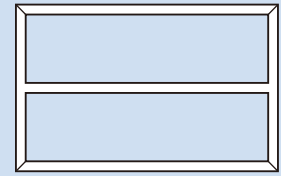

SIGN HOLDER

with wall mount attachment

- # MCW57 5 1/2" x 7"
- # MCW711 7" x 11"
- # MCW114 11" x 14"

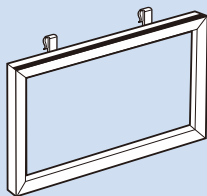

GRIDWALL SIGN HOLDER

Signholder mounts on gridwall

- # MGW57 5 1/2" x 7"
- # MGW711 7" x 11"

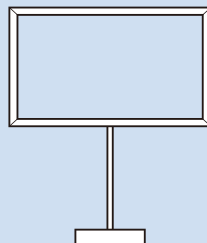

SIGN HOLDER

on 6" post with bracket for mounting to 1" square tubing.

- # MCT57-6P 5 1/2" x 7"
- # MCT711-6P 7" x 11"

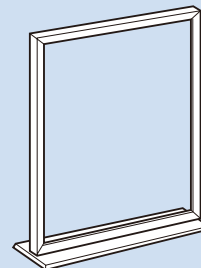

VERTICAL SIGN HOLDER

On 4" x 11" base (base has felt bottom)

- # MCF114V 11" x 14"
- # MCF22V 14" x 22"
- # MCF28V 22" x 28"



VERTICAL SIGN HOLDER

with wall mount attachment.

- # SPW22V 14" x 22"
- # SPW28V 22" x 28"



CHROMED



ROUND CORNER SIGN HOLDER

Fits 1/4" and 3/8" stems

SR57 5-1/2" × 7"

SR711 7" × 11"

SR114 11" × 14"

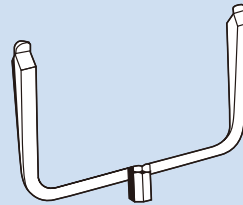

SIGN HOLDER

Fittings will accept either

1/4" or 3/8" stems

5-5/8" wide

UC4

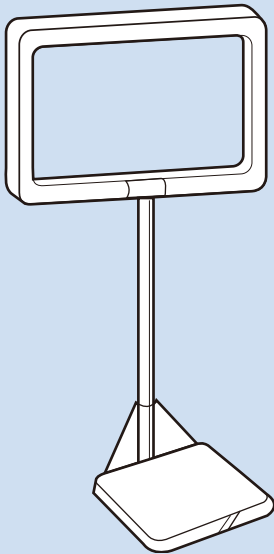

SHOVEL BASE SIGN HOLDER

Item	Frame Size	Stem Size
# CFS57	5-1/2" × 7"	8"
# CFS711	7" × 11"	10"
# CFS114	11" × 14"	12"

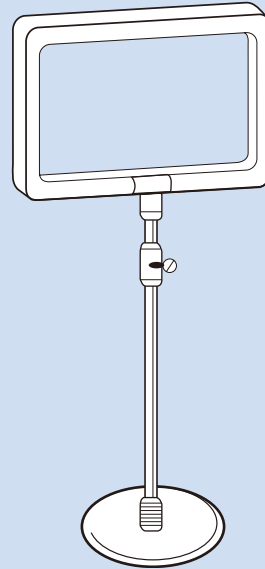

ROUND BASE SIGN HOLDER

Item	Frame Size	Stem Size	Base Size
# CFR57	5-1/2" × 7"	9" - 18"	4"
# CFR711	7" × 11"	12" - 24"	5"
# CFR114	11" × 14"	12" - 24"	5"

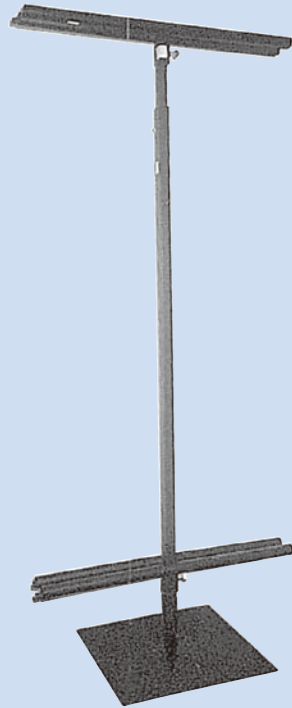

DOUBLE BANNER STAND

Adj. Height 4' to 8'
14" × 14" metal base
Black finish
BANNER -2

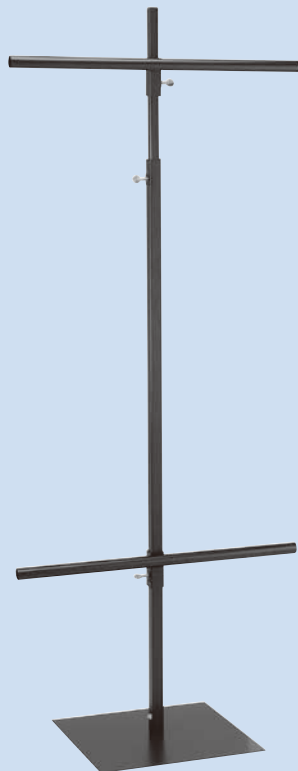

SINGLE BANNER STAND

Adj. Height 4' to 8'
14" × 14" metal base
Black finish
BANNER -1



ALLIGATOR CLIP SIGN HOLDER WITH BAMBOO BASE

Steel rope with alligator clip.
Overall: 4"H
U9-1



ALLIGATOR CLIP SIGN HOLDER WITH METAL AND MAGNET BASE

Chrome wire with alligator clip.
Overall: 4"H
U9-4



ALLIGATOR CLIP SIGN HOLDER WITH POLYRESIN BASE

Steel rope with alligator clip.
Overall: 4-1/2"H

Item	Color
# U9-2BE	Blue
# U9-2GN	Green
# U9-2OR	Orange
# U9-2RD	Red



ALLIGATOR CLIP SIGN HOLDER WITH WEIGHTED BASE

Black wire with alligator clip.
2" diameter metal base
Overall: 4"H
U9-5



ALLIGATOR CLIP SIGN HOLDER WITH ACRYLIC BASE

Chrome wire with alligator clip.
Overall: 4"H
U9-3



ALLIGATOR CLIP SIGN HOLDER WITH WEIGHTED BASE

Black wire with alligator clip.
2" diameter metal base
Overall: 7"H
U9-6

V

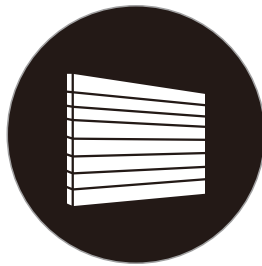

SLATWALL

CHAPTER	DIVISION	CONTENTS
V	01	SLATWALL
	02	METAL ACCESSORIES
	03	ACRYLIC ACCESSORIES
	04	MERCHANDISERS



SLATWALL HOOKS
1/4" wire with rounded tips

- UTILITY HOOK**
SWH Chrome
SWH-B Black
SWH-W White



4" Long
SWH4

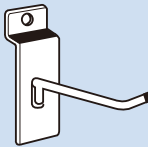

6" Long
SWH6

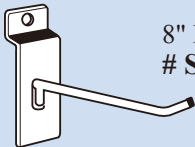

8" Long
SWH8

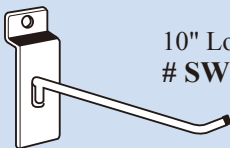

10" Long
SWH10

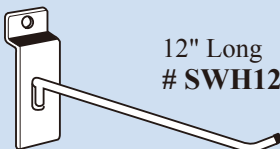

12" Long
SWH12

CHROME

- # SWH1 1"L
- # SWH2 2"L
- # SWH4 4"L
- # SWH6 6"L
- # SWH8 8"L
- # SWH10 10"L
- # SWH12 12"L

BLACK

- # SWH1B
- # SWH2B
- # SWH4B
- # SWH6B
- # SWH8B
- # SWH10B
- # SWH12B

WHITE

- # SWH1W
- # SWH2W
- # SWH4W
- # SWH6W
- # SWH8W
- # SWH10W
- # SWH12W

12" FACEOUT

- Square tubing
SW12 Chrome
SW12-B Black
SW12-W White

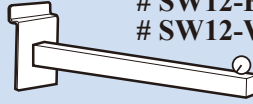

6 BALL WATERFALL

- Square tubing 16" Long
SW6B Chrome
SW6B-B Black
SW6B-W White

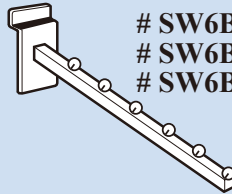

5 HOOK WATERFALL

- Square tubing 16" Long
SW5H Chrome
SW5H-B Black
SW5H-W White

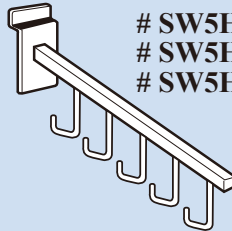

FACEOUT

- Rectangular tubing
RW6 6" L Chrome
RW12 12" L Chrome



EXTENDABLE FACEOUT

- At 9", 12 & 15"L Chrome
RW9-EXT



7 CUBE WATERFALL

- Rectangular tubing 15" Long
RW7C Chrome

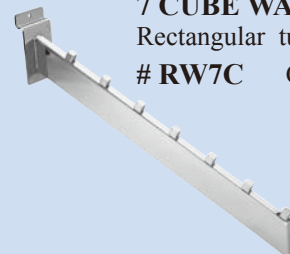

5 HOOK WATERFALL

- Rectangular tubing 17" Long
RW5H Chrome

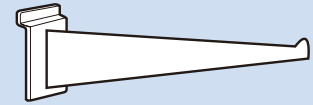
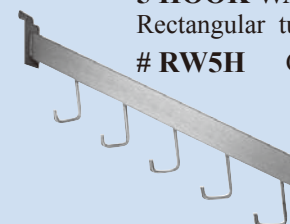

CHROME PLATED KNIFE SHELF BRACKET

- # SW6KB 6"L
- # SW8KB 8"L
- # SW10KB 10"L
- # SW12KB 12"L
- # SW14KB 14"L
- # SW16KB 16"L



CHROME PLATED ADJUSTABLE SHELF BRACKETS

- # SW10ADJ 10"L
- # SW12ADJ 12"L
- # SW14ADJ 14"L



CHROME PLATED 10" HANGRAIL BRACKET

- # SWRT For 1/4" round tubing
- # SWRM For 1" & 1 1/8" round tubing



CHROME PLATED BLADE BRACKET
For 1/2" x 1 1/2" rect. tubing

- # SW3RT 3"L
- # SW10RT 10"L
- # SW12RT 12"L

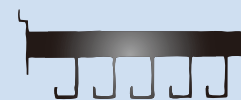

5 HOOK FACEOUT
Rectangular tubing 15" Long
WH5H Chrome



METAL ACCESSORIES

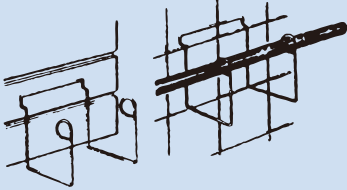
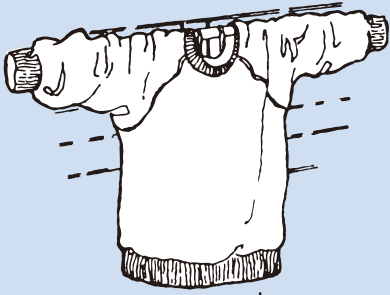

SCARECROW DISPLAYER

Fits slatwall or gridwall. Put together in seconds-just slip bar through rings.
42" long all chrome plated
TKGS4

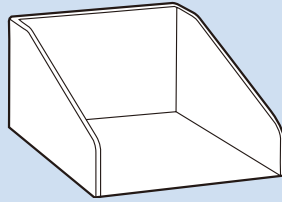

DELUXE SHIRT OR SWEATER BIN

Made from perforated metal, complete with black edge trim, 12"W x 16" Deep x 8"H. Available in white or black powder coated

- # **PM700B** Black
- # **PM700W** White

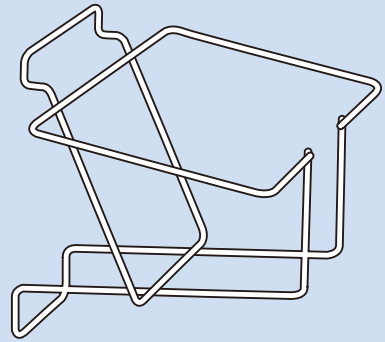

SLATWALL HOSIERY BIN

8" Wide x 5 3/4" Deep x 4 1/2" High

- # **SWPH** Chrome

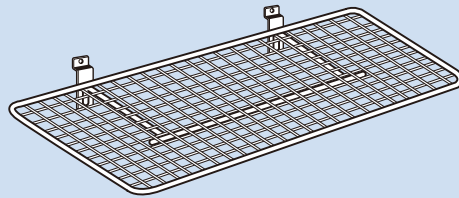

SLATWALL GRID SHELF

Made in 1" grid pattern to hold all types of merchandise. Available in Black, White or Chrome.

10" x 24"

- # **WS702C** Chrome
 - # **WS702B** Black
 - # **WS702W** White
- 12" x 24"

- # **WS703C** Chrome
- # **WS703B** Black
- # **WS703W** White

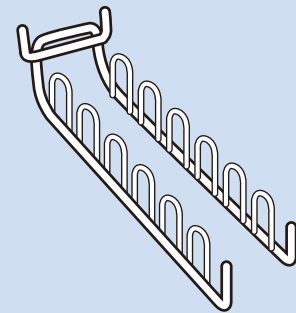

TENNIS RACQUET DISPLAYER

Displays 7 racquets.

- # **3469** Chrome



SLATWALL SIGN HOLDER

- # **MSW57** 5 1/2" x 7" Chrome
- # **MSW711** 7" x 11" Chrome

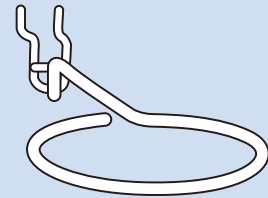

2 1/2" DIA. BALL HOLDER

- # **BB1** Chrome

5 1/2" DIA. BALL HOLDER

- # **BB2** Chrome



HAT HOLDER

4 1/2" High x 8" Deep
3" ring.

- # **SWHH** Chrome
- # **SWHH-B** Black
- # **SWHH-W** White

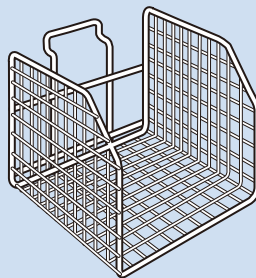

ALL WIRE SHIRT AND SWEATER BIN

One piece construction made in 1" grid pattern,
16" Deep x 10" Wide x 8" High

- # **WS707C** Chrome
- # **WS707B** Black
- # **WS707W** White

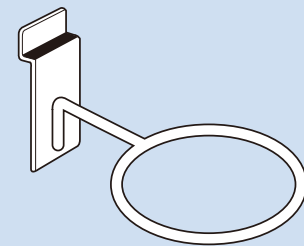

5" DIA. BALL HOLDER

with 4" extension

- # **BB2-1** Zinc
- # **BB2-3** Chrome

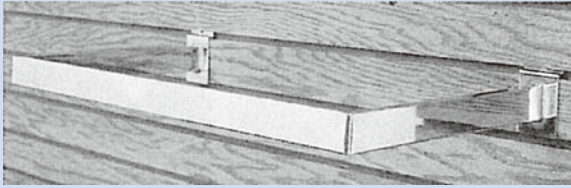
**SLATWALL U-SHAPED HANGRAIL**

Made of 1/2" × 1-1/2" rect. tube,
Size: 12" × 24"

- # **KHS681-RT** Chrome
- # **KHS681-RTB** Black
- # **KHS681-RTW** White

**SLATWALL U-SHAPED HANGRAIL**

Made of 1-1/4" round tube,
Size: 12" × 24"

- # **KHS681** Chrome
- # **KHS681-B** Black
- # **KHS681-W** White

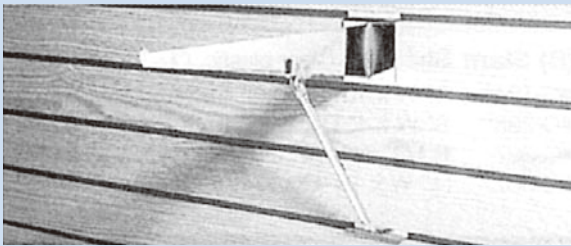
**HEAVYDUTY SUPPORT ARM**

Increases weight load capability of slatwall. Use with knife or hangrail brackets. 3/8" dia arm with "U" shaped cup. Cup is secured to bracket w/2 screws. Chrome

- # **SWARM7** 7-3/4"L For brackets 8"L & 10"L
- # **SWARM11** 11-1/2"L For brackets 12"L & 14"L

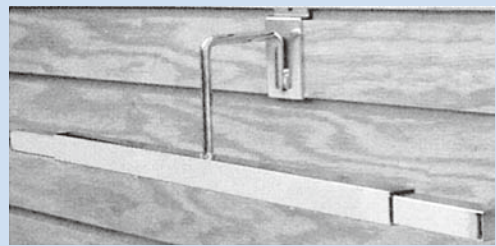
**SLATWALL SCARECROW**

Adjustable from 18" to 28" to 35"

- # **SWSC** Chrome
- # **SWSC-B** Black
- # **SWSC-W** White

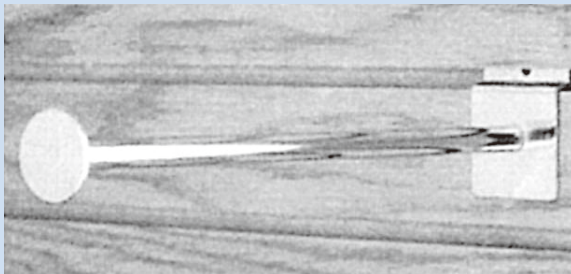
**ROUND TUBING FACEOUT**

5/8" dia × 12" long
w/disk end, chrome

- # **SW11**

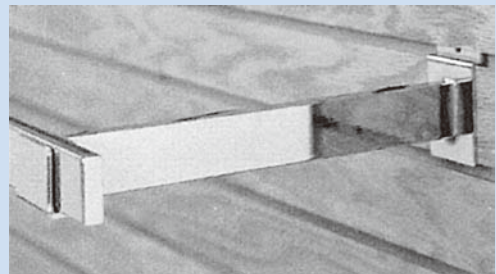
**SLATWALL HANGRAIL BRACKETS**

Made of 1/2" × 1-1/2" rect. tube,
Holds 1/2" × 1-1/2" rectangular hangrail.

- # **SW3RTR** 3"L Chrome
- # **SW10RTR** 10"L Chrome
- # **SW12RTR** 12"L Chrome
- # **SW12RTR-B** 12"L Black
- # **SW12RTR-W** 12"L White

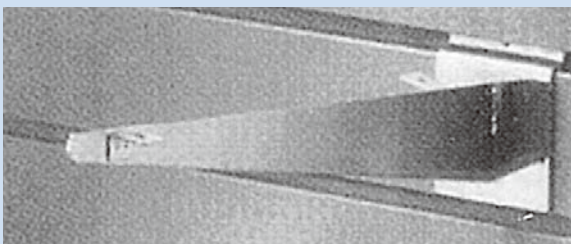
**SLATWALL SHELF BRACKET NO LIP**

Center type, for wood shelves, Chrome

- # **4087-12** 12"L
- # **4087-14** 14"L

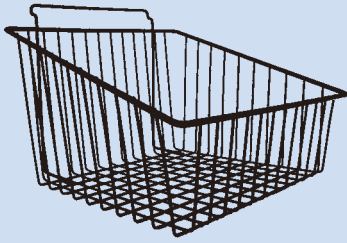

SLOPED FRONT BASKET
 12"W × 12"D × 4"H (Front) ×
 8"H (Rear)
 # V2-1 Chrome
 # V2-1B Black
 # V2-1W White



NARROW BASKET
 12"W × 6"D × 6"H
 # SWB1266 Chrome
 # SWB1266-B Black
 # SWB1266-W White

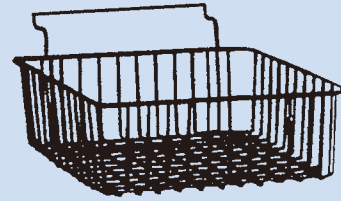

SHALLOW BASKET
 12"W × 12"D × 4"H
 # SWB12124 Chrome
 # SWB12124-B Black
 # SWB12124-W White



DEEP BASKET
 12"W × 12"D × 8"H
 # SWB12128 Chrome
 # SWB12128-B Black
 # SWB12128-W White

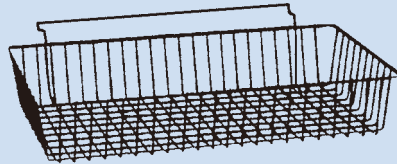

SHALLOW BASKET
 24"W × 12"D × 4"H
 # SWB12244 Chrome
 # SWB12244-B Black
 # SWB12244-W White

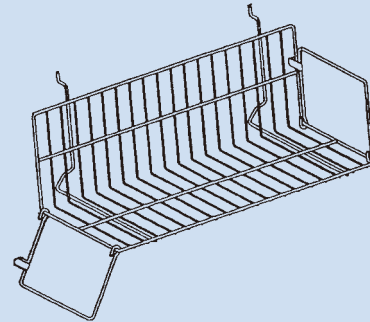

VIDEO/BOOK SHELF
 Wire rack has hinged ends to use singly or in
 a continued run. Tilt back design keeps goods
 from falling forward, 5³/₄" deep × 6³/₄" high
 Black White Length
 # VCS24B-S # VCS24W-S 24" Wide
 # VCS48B-S # VCS48W-S 48" Wide

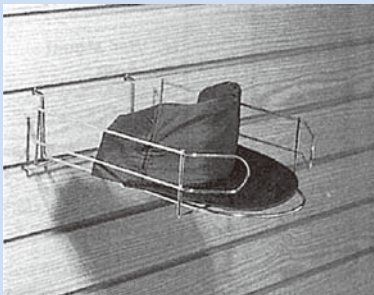

CAP HOLDER
 Neatly holds 9 to 12 athletic
 caps or visors.
 8¹/₂"W × 10³/₄"D × 2¹/₂"H
 # CRS-C Chrome
 # CRS-B Black
 # CRS-W White

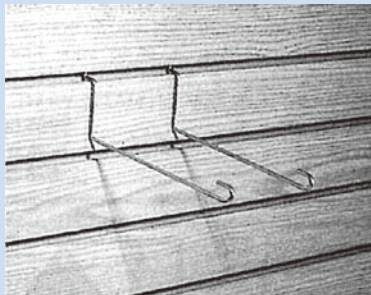

CAP HOLDER
 Rack holds one visored cap.
 4-5/16"W × 6¹/₂"D × 2³/₄"H
 # CAP-S-C Chrome

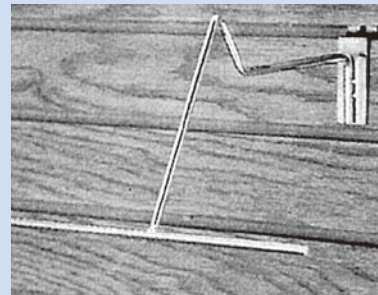

WESTERN HAT DISPLAY
 Bracket made of 1/4" dia rod
 9³/₄" × 9¹/₂" × 6"
 # SWHB Chrome

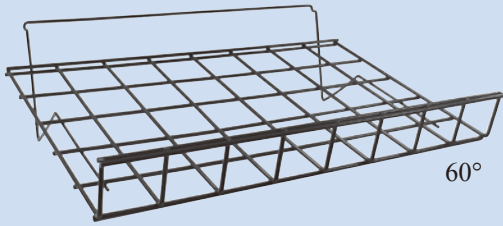

60°

SLANT SHELF WITH LIP

15" D x 24" W

- # SWS6 Chrome
- # SWS6B Black
- # SWS6W White

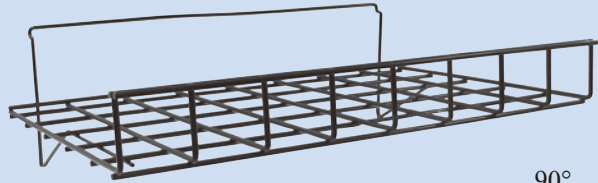

90°

STRAIGHT SHELF WITH LIP

15" D x 24" W

- # SWS8 Chrome
- # SWS8B Black
- # SWS8W White

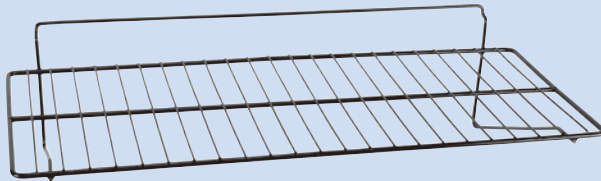

STRAIGHT SHELF

12" D x 24" W

- # SW9 Chrome
- # SW9B Black
- # SW9W White

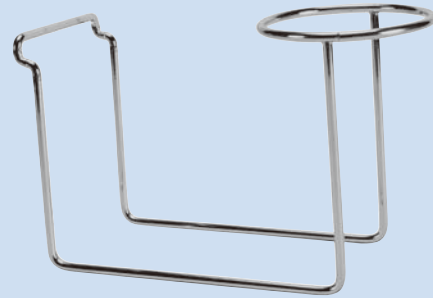

4" DIA BALL OR CAP HOLDER

6" H x 7-1/2" Deep

- # SWBH4-C Chrome
- # SWBH4-B Black
- # SWBH4-W White

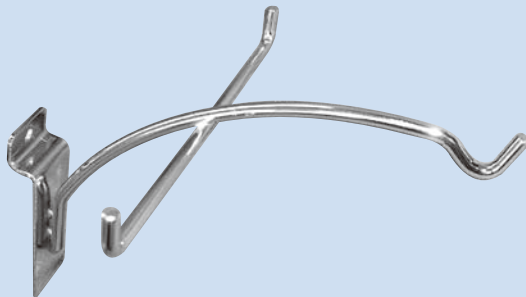

EYEGASSES DISPLAY

5-1/2"D x 5-1/2"W

- # SWEG Chrome
- # SWEG-Z Zinc
- # SWEG-B Black
- # SWEG-W White

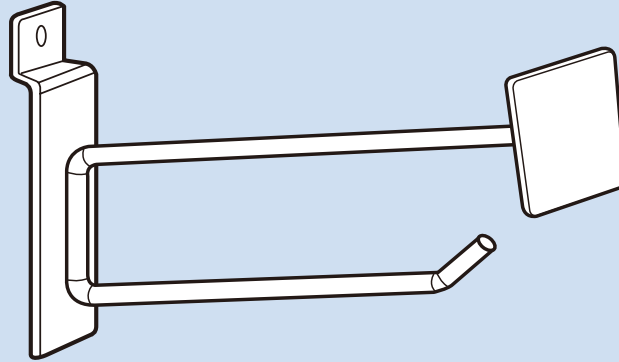

SLATWALL SCANNER HOOK ZINC

Length	Metal Plate: 1-3/8"×3"×1.5mm Wire Dia. 0.187"	Metal Plate: 1-3/8"×3"×1.5mm Wire Dia. 0.225"	Metal Plate: 1-3/8"×2-1/8"×1.5mm Wire Dia. 0.187"	Metal Plate: 1-3/8"×2-1/8"×1.5mm Wire Dia. 0.225"
4"	M13S4-ME	M13S4-HD	M12S4-ME	M12S4-HD
6"	M13S6-ME	M13S6-HD	M12S6-ME	M12S6-HD
8"	M13S8-ME	M13S8-HD	M12S8-ME	M12S8-HD
10"	M13S10-ME	M13S10-HD	M12S10-ME	M12S10-HD
12"	M13S12-ME	M13S12-HD	M12S12-ME	M12S12-HD

SLATWALL SCANNER HOOK CHROME

Length	Metal Plate: 1-3/8"×3"×1.5mm Wire Dia. 0.187"	Metal Plate: 1-3/8"×3"×1.5mm Wire Dia. 0.225"	Metal Plate: 1-3/8"×2-1/8"×1.5mm Wire Dia. 0.187"	Metal Plate: 1-3/8"×2-1/8"×1.5mm Wire Dia. 0.225"
4"	M13S4-ME-C	M13S4-HD-C	M12S4-ME-C	M12S4-HD-C
6"	M13S6-ME-C	M13S6-HD-C	M12S6-ME-C	M12S6-HD-C
8"	M13S8-ME-C	M13S8-HD-C	M12S8-ME-C	M12S8-HD-C
10"	M13S10-ME-C	M13S10-HD-C	M12S10-ME-C	M12S10-HD-C
12"	M13S12-ME-C	M13S12-HD-C	M12S12-ME-C	M12S12-HD-C

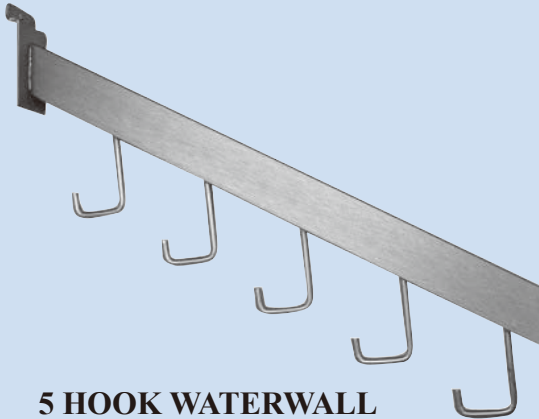

5 HOOK WATERWALL

To fit on slatwall
Made of 1/2" × 1-1/2" rectangular tubing
Satin Chrome
RW5H-SC 17"L



STRAIGHT FACEOUT

To fit on slatwall
Made of 1/2" × 1-1/2" rectangular tubing
Satin Chrome
RW12-SC 12"L

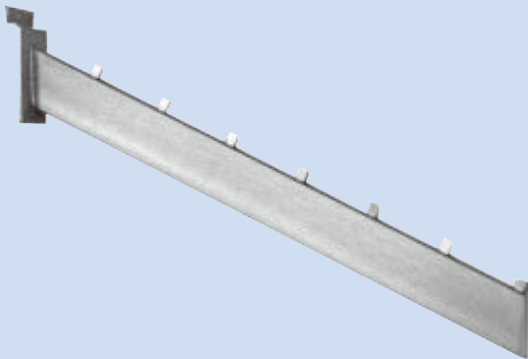

7 CUBE WATERWALL

To fit on slatwall
Made of 1/2" × 1-1/2" rectangular tubing
Satin Chrome
RW7C-SC 15"L



KNIFE SHELF BRACKET

To fit on slatwall
Satin Chrome
SW12KB-SC 12"L
SW14KB-SC 14"L



SLATWALL HOOKS

1/4" wire with rounded tips
Back plate in Satin Chrome
SWH4-SC 4"L
SWH6-SC 6"L
SWH8-SC 8"L
SWH10-SC 10"L

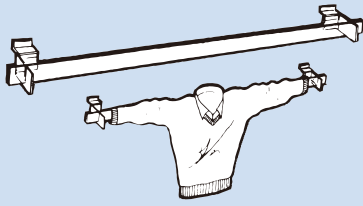
**Scarecrow Displayer**

47" wide extends out 2"

SP2171S

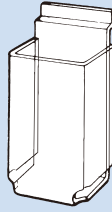
**Literature Displays**

4"W × 9"H × 2¼"D

DP2111

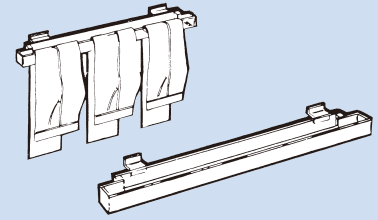
**Pants Bar Displayer**

Can also be used to drape towels, linens, etc. 2"H × 32"W

SP2168S

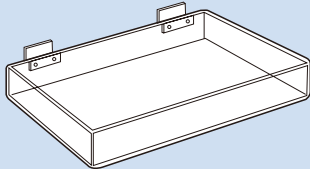
**Acrylic Tray**

Clear plexi all-purpose tray with two metal slatwall clips. ⅜" thick.

SP1994-10 10" × 14" × 2"

SP1994-8 8" × 12" × 2"

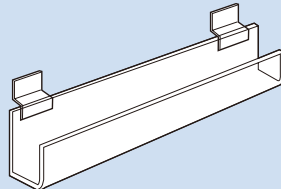
**Acrylic Universal Trough**

Ideal for video and computer cassettes and greeting cards. Slopes back to keep merchandise in place. Unit has 4" back, 3" front, 2" deep × 24" long.

JD416SL

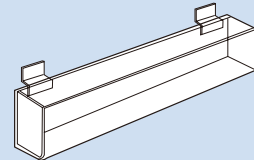
**Literature Displays**

For use with leaflets or brochures. 25"W × 3¾"H × 2½"D, ⅜" thick.

SP1998

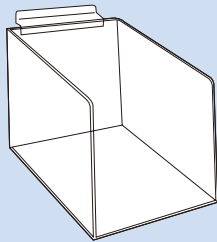
**Acrylic Tray**

10"W × 16"D × 10"H, ⅜" thick.

JD864SL

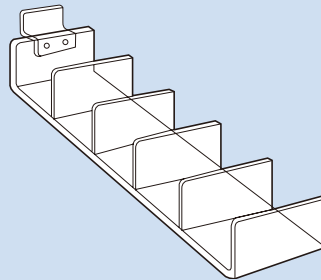
**Clutch Bag Displayer**

Holds 5 bags, 1/4" thick.

SP2007

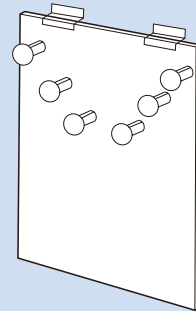
**Costume Jewelry Displayer**

18"H × 13"W. Six 3" rods with end caps for draping jewelry.

SP2117S

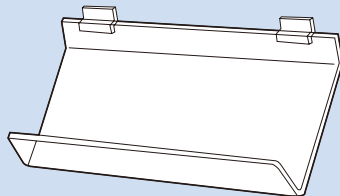
**Acrylic Downslant Shelf**

For shirts, linens, books, etc. 30"W × 13"D Tray with 1" front lip

DP2350

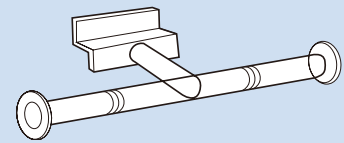
**Acrylic Jewelry Displayer**

1" rod 15¼" long extends 4" from wall.

SP2024S

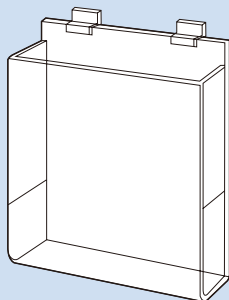
**Literature Displays**

9"W × 11"H × 2¾"D

DP2115

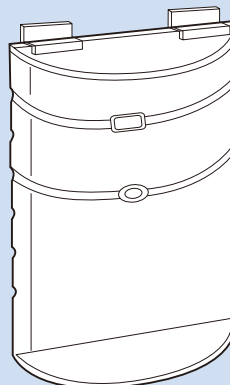
**Belt Displayer**

Half cylinder 18"W × 19"H

SP2018S

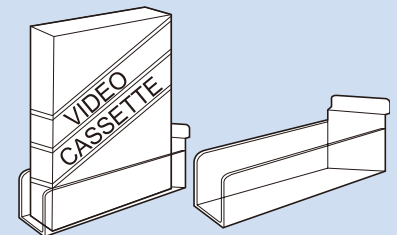
**Video Cassette Displayer**

ID860L -Left angle

ID860R -Right angle



ACRYLIC ACCESSORIES

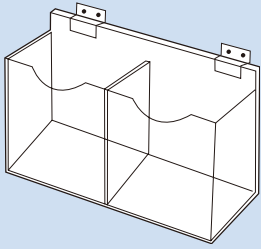

Double Hosiery Box
15" W × 6½"H × 4½" Deep
SP2074S

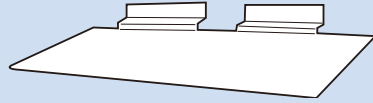

Clear Styrene Shoe Shelf
Injection Molded
SW410S 4" × 10"
SW612S 6" × 12"

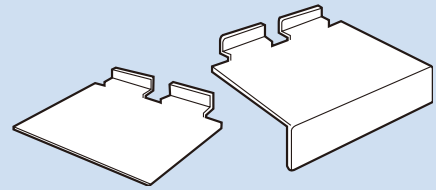

Children 3"x5" Shoe Displayers
Ideal for displaying childrens shoes, sneakers, etc. Available with or without 1" × 5" slot for product identification or pricing.
ID823 without sign slot
ID853 with sign slot

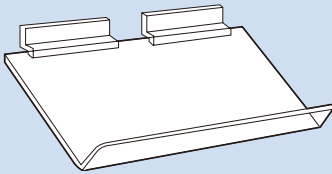

4" × 8" Down Slant Displayer
For use where frontal and top view is desired, Great for shoe, telephone and electronics display.
ID821

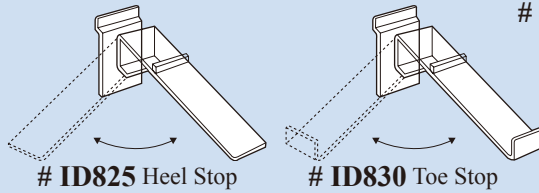

Down Slant Shoe Displayers
For mens or ladies shoes. Displays shoes in any position left, right or front. 3½"x10"
ID825 Heel Stop
ID830 Toe Stop

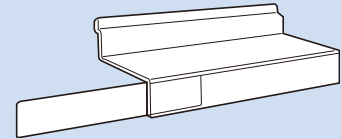

Clear Styrene Shoe Shelf with Sign Slot
3½" × 10" clear Shelf with slot for 2" × 10" card, Injection Molded, Ideal for product identification or pricing.
ID850

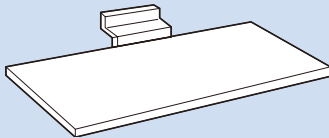

Acrylic Feature Shelf
JD654SL 5" W × 6"L
JD661SL 6" W × 12"L

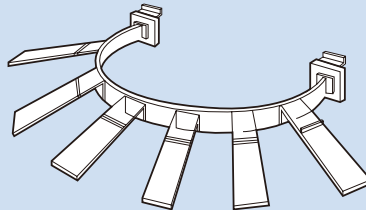

Curved Multi Shoe Displayer
6 shoe display with heel stops attaches to 15" wide curve.
SP1990

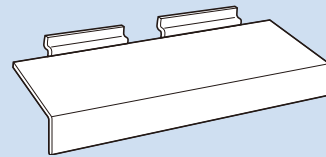

Clear Styrene Shoe Shelf with Sign Slot
4" × 10" clear Shelf with slot for 1.25"x10" card, Injection Molded, Ideal for product identification or pricing.
ID851

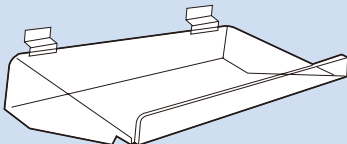

Acrylic Extra Support Shelf
3/16" clear acrylic with bent gussets for extra support.
JD870SL 8" W × 12"L
JD876SL 10" W × 16"L
JD878SL 10" W × 24"L
JD879SL 10" W × 36"L

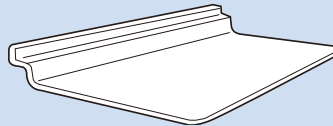

Slatwall Shoe Shelves
SW310 3" W × 10"L
SW48 4" W × 8"L
SW410 4" W × 10"L
SW412 4" W × 12"L



Acrylic Signholders
For Slatwall

Item	H × W
# JD516SW	7" × 5½"
# JD517SW	5½" × 7"
# JD518SW	11" × 7"
# JD519SW	7" × 11"
# JD522SW	14" × 11"
# JD523SW	11" × 14"

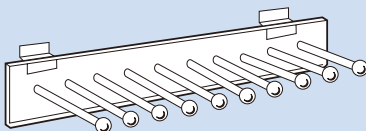

Acrylic Belt & Tie Displayer
20" wide, 10-2½" Chrome spokes for hanging.
SP1979S

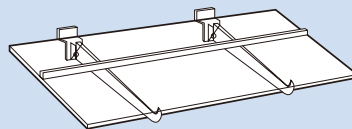

Acrylic Shoe Shelf
Heel stop-3/16" thickness
Brackets not included.
SW1024 10" × 24"
SW1048 10" × 48"
SW1224 12" × 24"
SW1248 12" × 48"

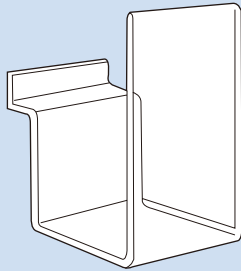

SLATWALL ACRYLIC VERTICAL DISPLAY FOR SHOES

Displays shoe bottom 3-1/2"W x 7"H

2365

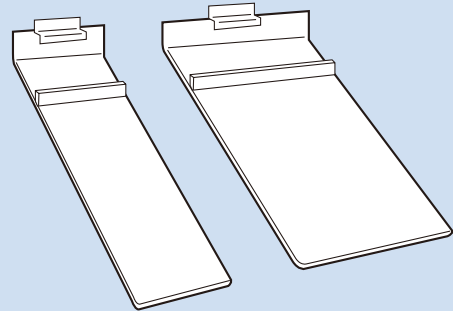

SLATWALL ACRYLIC SHOE FACEOUTS

Single wide

2084 -Heel hold 10"L x 3"W

Double wide

2086 -Heel hold 10"L x 7"W

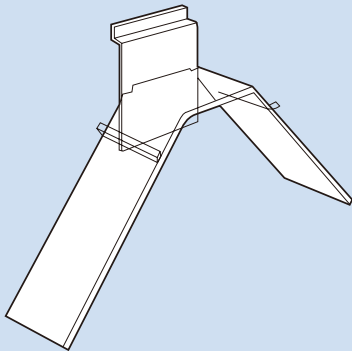

SLATWALL ACRYLIC DOUBLE SHOE SLANT

2 way

2081 -Heel hold - 16"L x 3"W

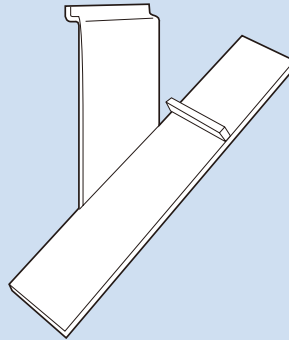

SLATWALL ACRYLIC LEFT SHOE SHELF

10"L x 3-3/8"W

2075 -1

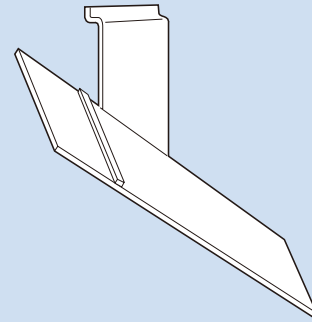

SLATWALL ACRYLIC RIGHT SHOE SHELF

10"L x 3-3/8"W

2073

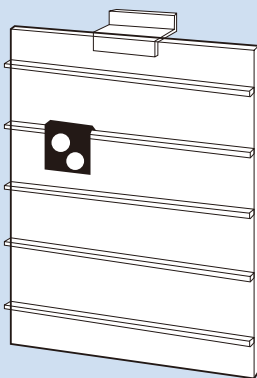

SLATWALL ACRYLIC EARRING PANEL

10"W x 14 1/4"H - Bronze back with channel for hanging 25-50 pair of carded earrings.

SP2118S

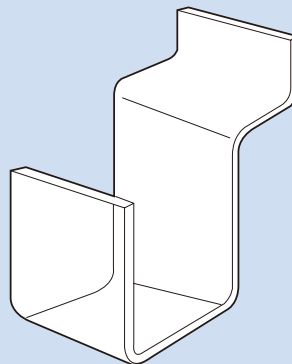

SLATWALL ACRYLIC HOOK

2240 - 1 1/2" wide

2" lip

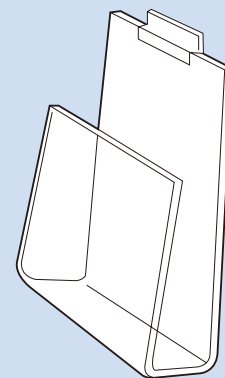

SLATWALL ACRYLIC HOLDER FOR BOOKS, VIDEO CASSETTES OR SOFTWARE

2170 - 4 1/4"W with 4 1/8" front lip. Holds items 7/8" to 1 1/4" thick



ACRYLIC ACCESSORIES

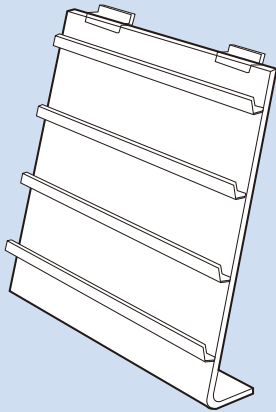

SLATWALL ACRYLIC JEWELRY CARD DISPLAY

8"W x 9"H
4 tiers high, holds 16-2" cards
2385

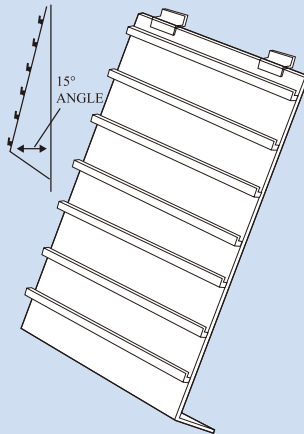

SLATWALL ACRYLIC JEWELRY CARD DISPLAY

15-7/16"W x 19"H
7 tiers high, holds 49-2" cards
226-2388

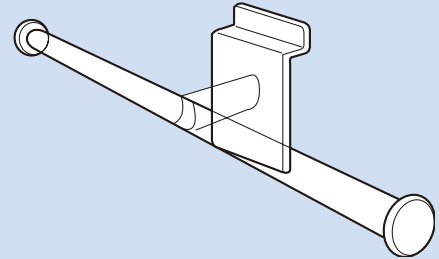

SLATWALL ACRYLIC JEWELRY T-BARS

Uses 1" diameter solid rod with 1-1/2" diameter ends 8" long
2326

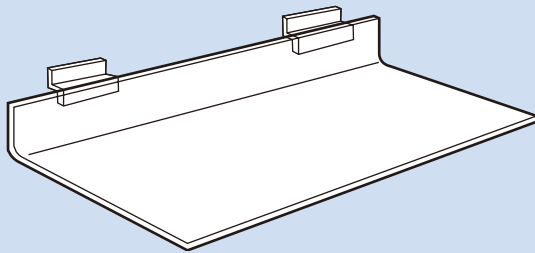

ACRYLIC FEATURE SHELF

12"W x 6-3/16"D
JD661SL-1

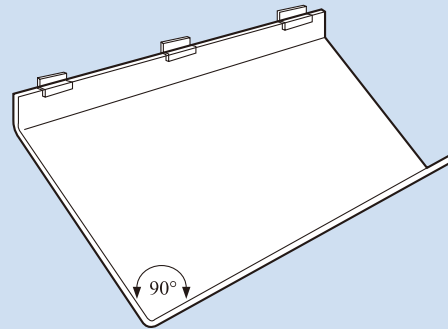

ACRYLIC SLANTED SHELF SLANT 45 DEGREE

23"W x 11-1/4"D with 1" front lip
226-2196

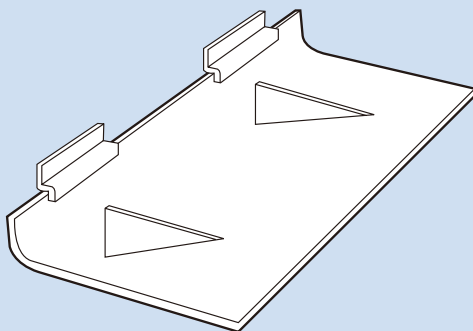

ACRYLIC DELUXE SHELF

16"W x 12"D
with 2 triangle supports on the bottom of shelf
226-2013

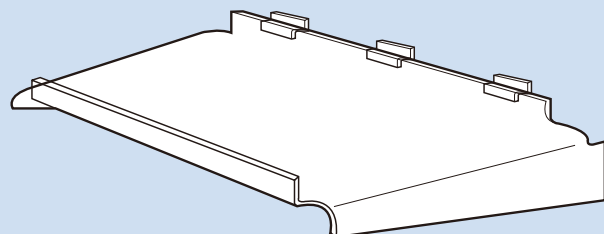

ACRYLIC EXTRA SUPPORT SHELF WITH BENT GUSSET

23-3/4"W x 14-5/8"D
226-2358

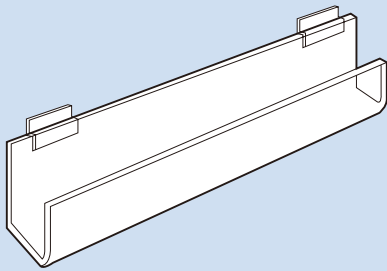

SLATWALL ACRYLIC J-RACK SHELVES

2-1/2" front lip, 3-1/2" back.
Depth is 1-3/4" outside, 1-1/2" inside
2270 11-3/4"L open both ends
2275 23-3/4"L open both ends
2291 35-3/4"L open both ends
2292 47-3/4"L open both ends

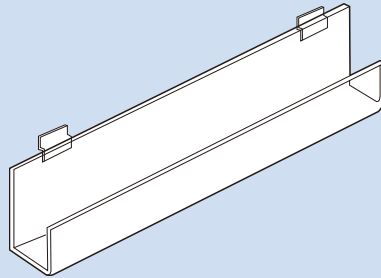

SLATWALL J-RACK TILT BACK SHELVES

With 20° tilt 23-3/4"L
open both ends
226-2375

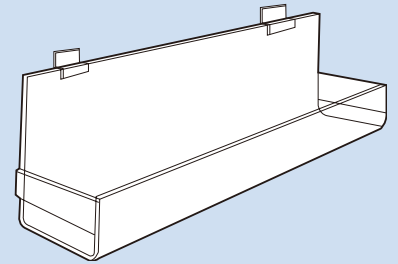

ACRYLIC STRAIGHT FLAT SHELF

23-13/16"W × 4-5/16"D
both ends closed
226-2364

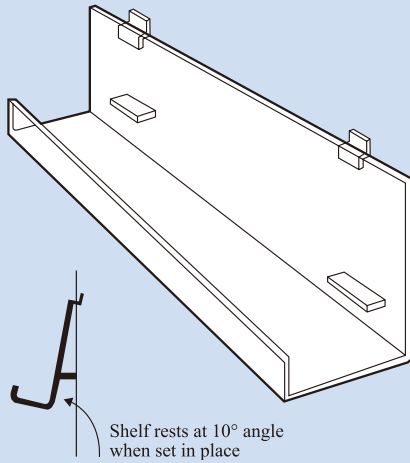

ACRYLIC LARGE TILT J-RACK SHELF

35-3/4" W × 5-7/8 " D
with 10 degree tilt
226-2308

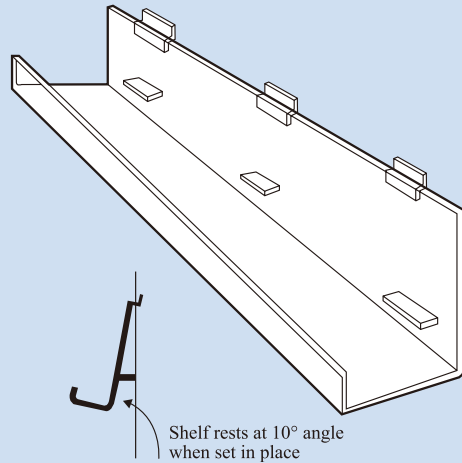

ACRYLIC LARGE TILT J-RACK SHELF

47-3/4" W × 5-7/8 " D
with 10 degree tilt
226-2309

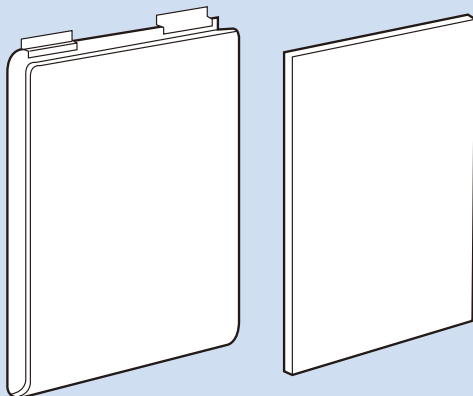

ACRYLIC T-SHIRT DISPLAY

sleeve 11-1/2" W × 14" H × 1" D
insert 11-1/4" W × 13-1/2" H
TSHIRT

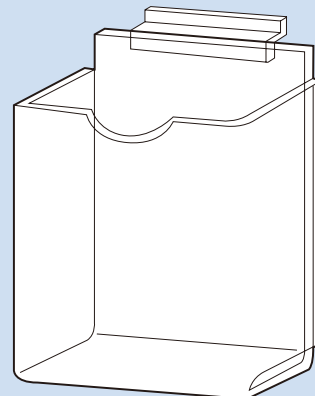

ACRYLIC SINGLE HOSEIERY BOX

7-1/2" W × 7-1/2 " H × 4" deep
HB1-SW



ACRYLIC ACCESSORIES

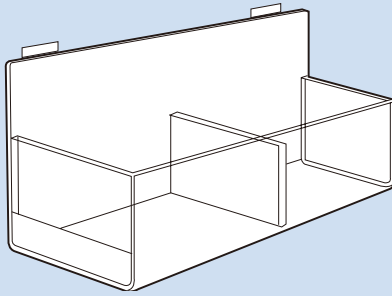

ACRYLIC HOSEIERY BIN
16"wide × 4¾"Deep × 4½"H (Front)
Non-slanting back, double bin.
S2421



ACRYLIC SLATWALL MIRROR
S2062 8"W × 10"H
S2064 10"W × 14"H

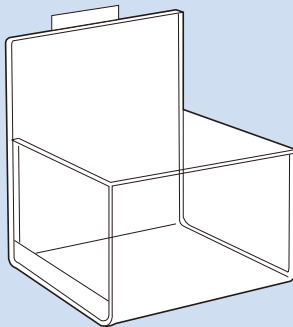

ACRYLIC HOSEIERY BIN
7¾"wide × 4¾"Deep × 4½"H (Front)
Non-slanting back, single bin.
S2420

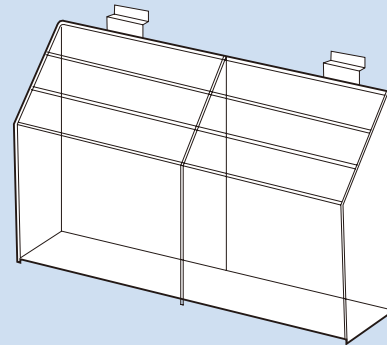

ACRYLIC BROCHURE HOLDER
Three tier. Fits slatwall
for 8½" × 11" literature
S2119

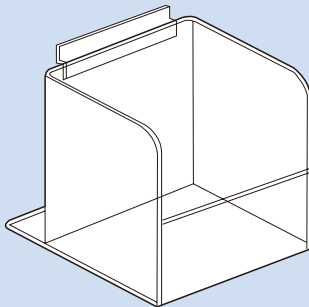

ACRYLIC HOSEIERY BIN
Slant back single bin.
SE23

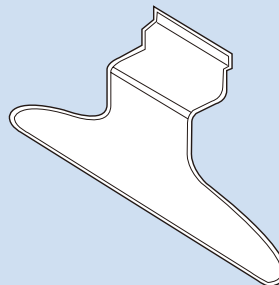

ACRYLIC DISPLAY HANGER
SHGR

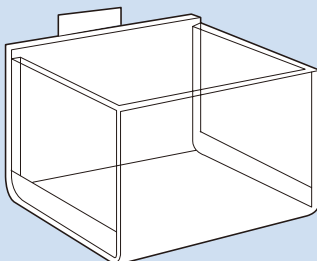

ACRYLIC GOLF GLOVE BIN
SGG1 5" × 5" × 5"

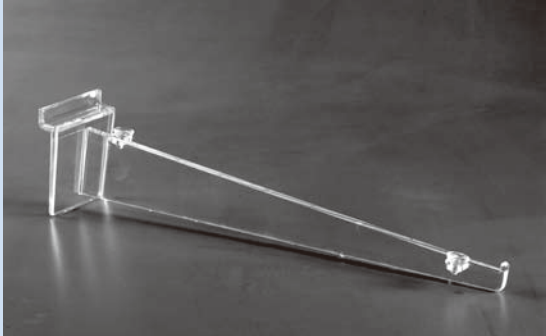

POLYCARBONATE SHELF BRACKET

With Suction Cups.

SW10KBPC 10"

SW12KBPC 12"

SW14KBPC 14"

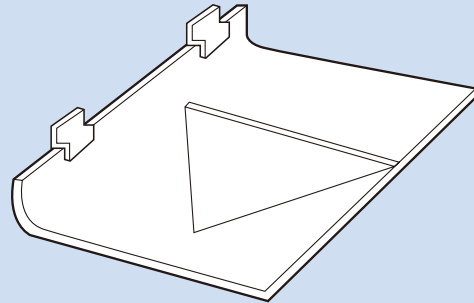

ACRYLIC 90° BRACED SHELF

With 1 triangle support on bottom of shelf, 1/4" thick.
9"W × 6"D

AC-2251

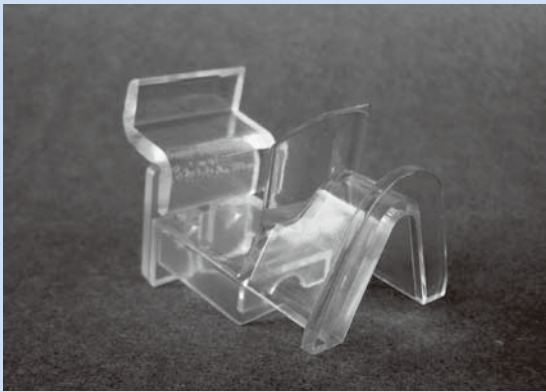

ACRYLIC SUNGLASSES SHELF

For Slatwall, 2-3/4"L

2191

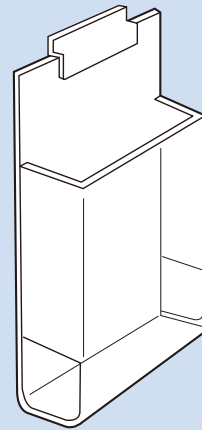

ACRYLIC SINGLE BROCHURE HOLDER

With 2" deep pocket, 1/8" thick.
8-3/4"W × 11"H

AC-2115

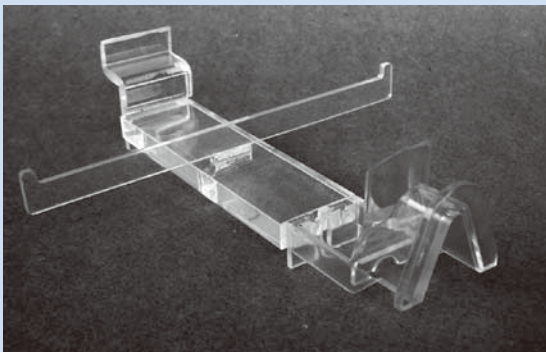

ACRYLIC SUNGLASSES SHELF

For Slatwall, 6-7/8"L × 5-15/16"W

2283

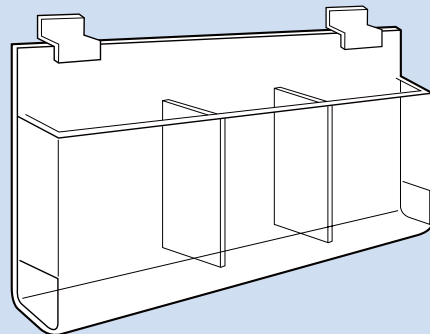

ACRYLIC TRIPLE BROCHURE HOLDER

With 1-7/8" deep pockets, 1/8" thick.
13"W × 9"H

AC-2444

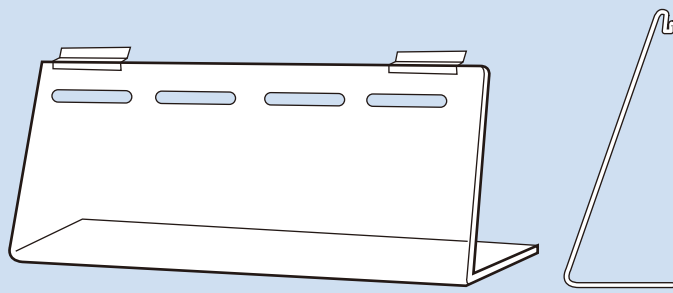

ACRYLIC TIE HOLDER FOR SLATWALL

24" × 10" × 4", 5mm thick

ATH

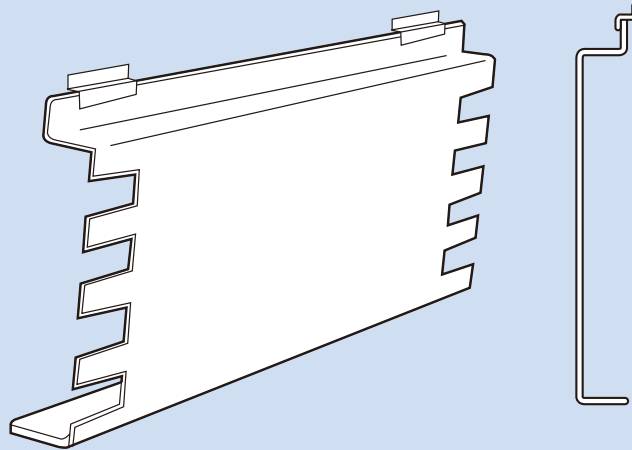

ACRYLIC BELT DISPLAY FOR SLATWALL

16" × 12" × 2", 3mm thick

ABD

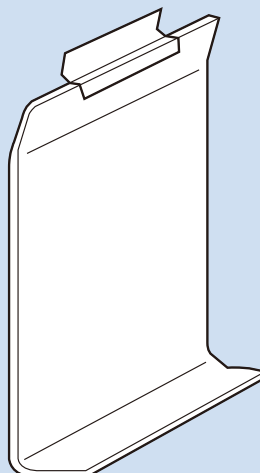

ACRYLIC SINGLE EASEL FOR SLATWALL

12" × 9" × 2", 3/16" thick

ASE-S

**SLATWALL 4-WAY DISPLAY**

Item	Color
# T4-1B	Black
# T4-1CH	Cherry
# T4-1MP	Maple
# T4-1W	White
# T4-1WA	Walnut

- Overall size
36" D × 36" W × 54" H
including 6" base
- Four center slatwall panels
24" W × 48" H

**SLATWALL CUBIC TOWER**

With Rotating Function

Item	Color
# T4-2B	Black
# T4-2CH	Cherry
# T4-2MP	Maple
# T4-2W	White
# T4-2WA	Walnut

- Overall size
20" D × 20" W × 54" H
including 6" base
- Four center slatwall panels
20" W × 48" H

**SLATWALL 2-WAY DISPLAY**

Item	Color
# T4-3B	Black
# T4-3CH	Cherry
# T4-3MP	Maple
# T4-3W	White
# T4-3WA	Walnut

- Overall size
24" D × 25-1/2" W × 54" H
including 6" base
- Center slatwall panels
24" W × 48" H
- Two side panels
6" W × 48" H



SLATWALL 4FT H UNIT

Item	Color
# T4-4B	Black
# T4-4CH	Cherry
# T4-4MP	Maple
# T4-4W	White
# T4-4WA	Walnut

- Overall size
24" D × 49-1/2" W × 54" H
including 6" base
- Center slatwall panels
48" W × 48" H
- Two side panels
24" W × 48" H



SLATWALL 2FT H UNIT

Item	Color
# T4-5B	Black
# T4-5CH	Cherry
# T4-5MP	Maple
# T4-5W	White
# T4-5WA	Walnut

- Overall size
24" D × 25-1/2" W × 54" H
including 6" base
- Center slatwall panels
24" W × 48" H
- Two side panels
24" W × 48" H

X



TAG GUN & FASTENERS

CHAPTER	DIVISION	CONTENTS
X	01	TAG GUN & FASTENERS



STANDARD NEEDLE GUNS
YH-31S



FINE NEEDLE GUNS
YH-31X



TAGGING NEEDLES
YH-202 Standard



TAGGING NEEDLES
YH-203 Fine

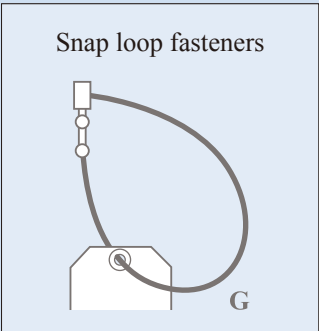
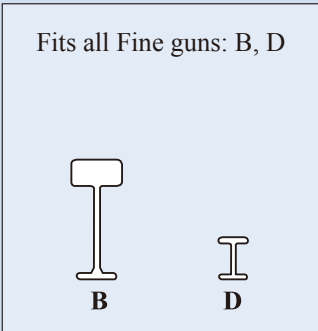
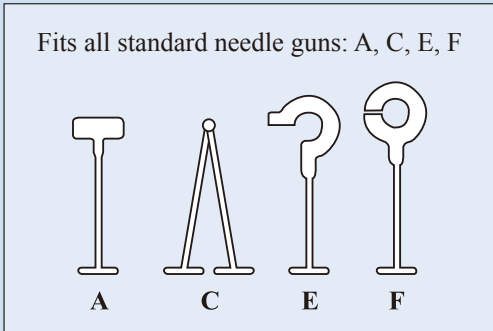

PLASTIC FASTENERS

- A: Standard pin - made of nylon or P. P.
sizes available:
12, 20, 25, 35, 45, 50, 65, 75, 100, 125 mm
- C: Double pin - made of nylon
sizes available: 50, 65, 75 mm
- E: Hook pin - made of nylon
sizes available: 15, 25, 35 mm
- F: Ring pin - made of nylon
sizes available: 15, 25, 35 mm

- B: Fine pin - made of nylon
sizes available:
15, 20, 25, 35, 50 mm
- D: I pin - made of nylon
sizes available: 7, 11, 15 mm
- G: Loop pin - made of nylon or P. P.
sizes available: 3, 4, 5, 6, 9 inch

Y

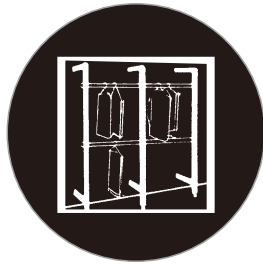

WALL SYSTEMS

CHAPTER	DIVISION	CONTENTS
Y	01	SQUARE TUBING
	02	RECTANGULAR TUBING
	03	ROUND TUBING
	04	SLACK WALL SYSTEM
	05	EPOXY COATED WALL SYSTEM

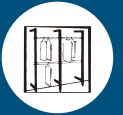

Outriggers are popular because of their easy installation. Since most of the weight is carried by the floor, the wall fastening needed is minimal. Install on 4' centers so standard hangrod and glass can be used.

**# STA300
CORNICE TYPE OUTRIGGER**

Constructed of 1" square tubing 84"H. Stands 15" from wall. Top cornice bracket is adjustable from 24" to 36". 1/2" slots in rear for all standards hangrail and shelf brackets. Polished chrome.

Takes:

- 1 - # LVGC** Leveler
- 1 - # STA-TB** Top bar
- 1 - # STA-B** Side Bar
- 1 - # STA-U** 1" sq. upright slotted one side.

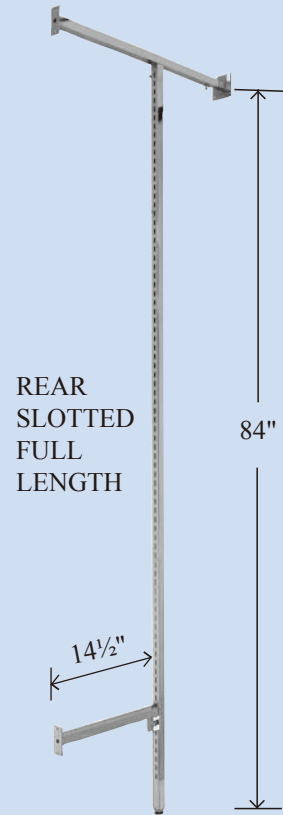

**# FIN300
FLUSH TOP OUTRIGGER**

Same as above, except no cornice arm. Polished chrome.

Takes:

- 1 - #LVGC** Leveler
- 2 - #FIN-B** Side Bar
- 1 - #FIN-U** 1" sq. upright slotted one side.

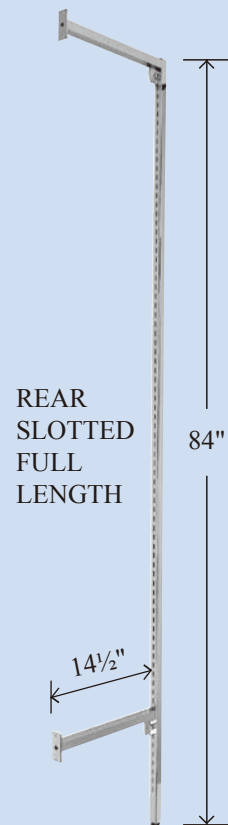

PS. # STA-B = # FIN-B



DELUXE OUTRIGGER WALL UNIT

Highly polished 1" × 2" chrome with 1/2" slots on rear.
87" high with 15" from wall.

All welded construction to acquire
most sturdiness.

- # **RFS50** - Chrome Plated
- # **RFS50B** - Black Epoxy
- # **RFS50W** - White Epoxy

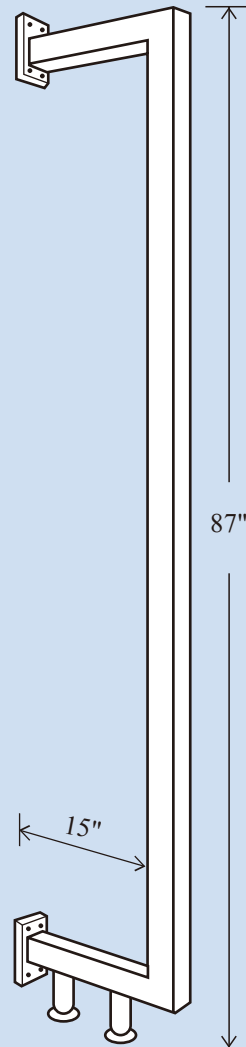

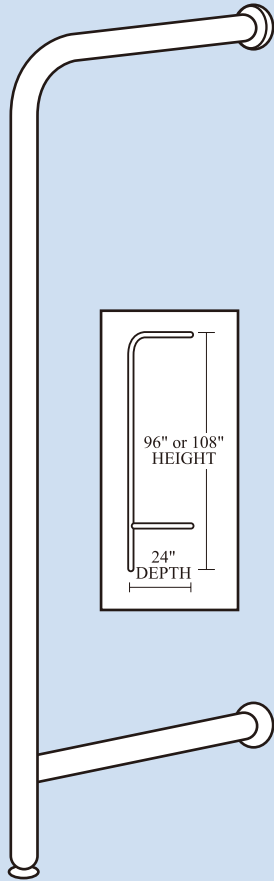

ROUND CHROME FIN

Constructed of round tubing. Stands 24" from wall. ½" slots in rear for all standards hangrail and shelf brackets. Chrome finish.

1¼" Diameter Outrigger

AR501 96" high

2" Diameter Outrigger

AT500-1 96" high

AT500-2 108" high



SPACE SAVER SLACK WALL SYSTEM

CROSSBAR

1" square chrome tubing. Holes drilled on 1" center to accommodate 12 folded slacks per running foot. 4' Long

R89-4

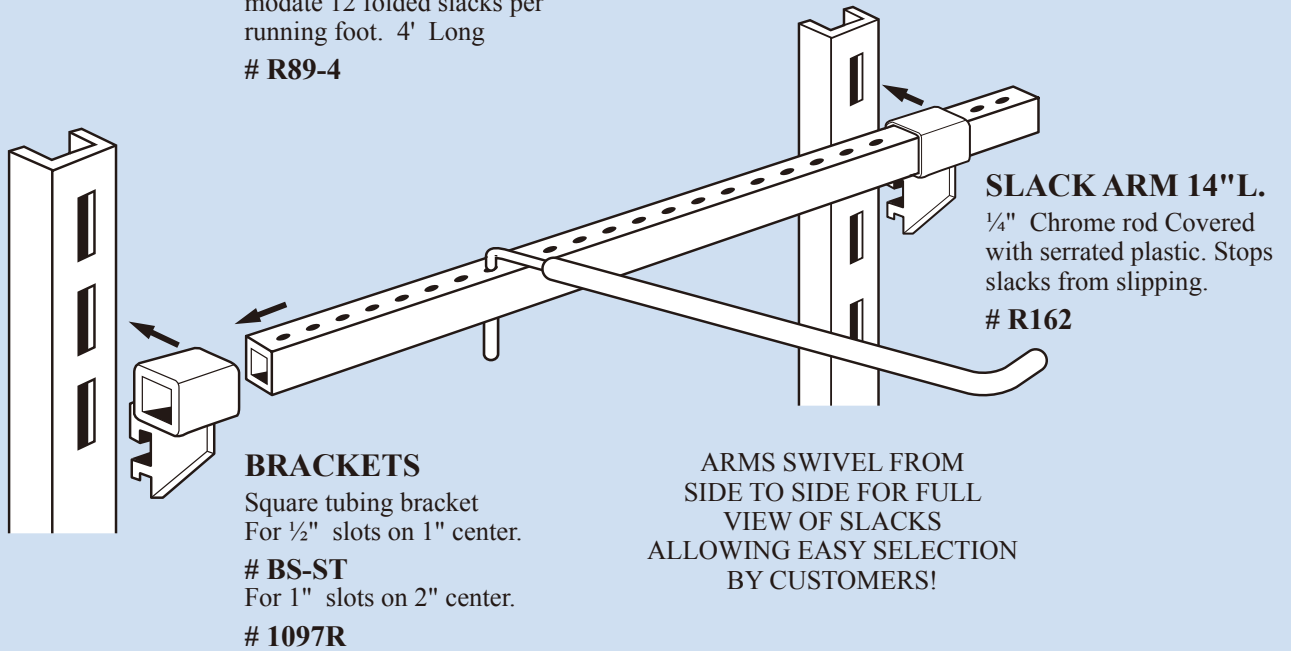

SLACK ARM 14" L.
 1/4" Chrome rod Covered with serrated plastic. Stops slacks from slipping.
 # R162

BRACKETS

Square tubing bracket
 For 1/2" slots on 1" center.

BS-ST

For 1" slots on 2" center.

1097R

ARMS SWIVEL FROM
 SIDE TO SIDE FOR FULL
 VIEW OF SLACKS
 ALLOWING EASY SELECTION
 BY CUSTOMERS!

SLOTTED STANDARDS

#125 MEDIUM DUTY

ITEM	LENGTH
# 125-3	3'
# 125-4	4'
# 125-5	5'
# 125-6	6'
# 125-7	7'
# 125-8	8'

#131 HEAVY DUTY

ITEM	LENGTH
# 131-3	3'
# 131-4	4'
# 131-5	5'
# 131-6	6'
# 131-7	7'
# 131-8	8'

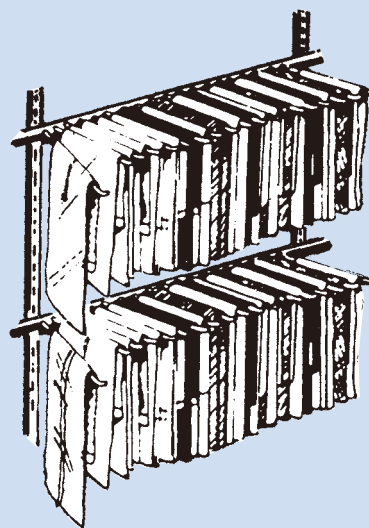

EPOXY COATED WALL SYSTEM



131 SINGLE SLOTTED STANDARD

Black or white epoxy, 6'L.

- # 131-6B Black
- # 131-6W White

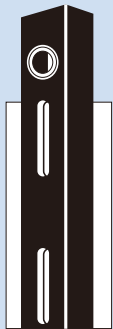

1204 SUPER STRENGTH STANDARDS

Black or White epoxy, 6'L.

- # 1204-6B Black
- # 1204-6W White

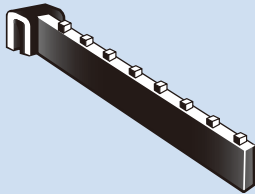

E. 8 CUBE WATERFALL WITH CHROME STRIPPING
Black or White Epoxy



A. STANDARD HANGRAIL BRACKET
Black or White Epoxy

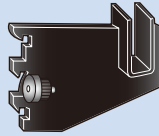

B. STUB HANGRAIL BRACKET
Black or White Epoxy



C. HEAVY DUTY HANGRAIL BRACKET
Black or White Epoxy

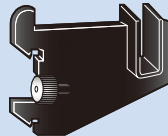

D. HEAVY STUB HANGRAIL BRACKET
Black or White Epoxy



F. 12" FACEOUT WITH CHROME STRIPPING
Black or White Epoxy

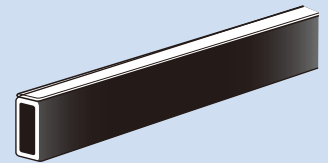

H. RECTANGULAR TUBING WITH CHROME STRIPPING
Black or White Epoxy

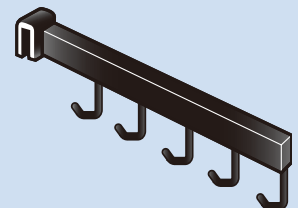

G. 5 HOOK WATERFALL
Black or White Epoxy

A. STANDARD HANGRAIL BRACKET 12" long
For Standards with 1/2" slots on 1" center
CR12B Black
CR12W White

B. STUB HANGRAIL BRACKET
For Standards with 1/2" slots on 1" center
BS3-B Black
BS3-W White

C. HEAVY DUTY HANGRAIL BRACKET 12" long
For Standards with 1" slots on 2" center
GR12B Black
GR12W White

D. HEAVY DUTY STUB HANGRAIL BRACKET
For Standards with 1" slots on 2" center
BR3-B Black
BR3-W White

E. 8 CUBE WATERFALL 17" long with 8 cubes
Constructed of 1/2" x 1-1/2" rectangular tubing. Top strip with cubes chrome plated to prevent scratching on epoxy coating by hanger hooks.
RH8C-B-STP Black
RH8C-W-STP White

F. 12" FACEOUT
12" long with 1 cube stop at end to prevent garments from sliding off. Constructed of 1/2" x 1-1/2" rectangular tubing. Chrome strip on top to prevent scratching on epoxy coating by hanger hooks.
RH12S-B-ST Black
RH12S-W-ST White

G. 5 HOOK WATERFALL
17" long with 5 hooks for handbag display. Constructed of 1/2" x 1-1/2" rectangular tubing.
RH5H-B Black
RH5H-W White

H. RECTANGULAR TUBING 4' Long.
Choice of black or white epoxy with chrome stripping.
RT4B-STP Black
RT4W-STP White

Z

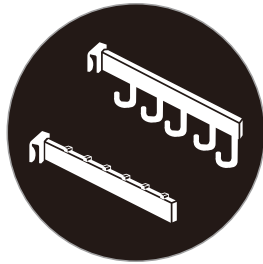





FACE-OUT & WATERFALL

CHAPTER	DIVISION	CONTENTS
Z	01	FACE-OUT & WATERFALL

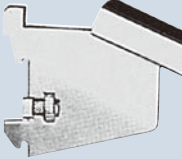
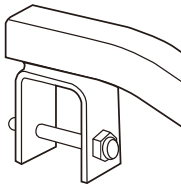
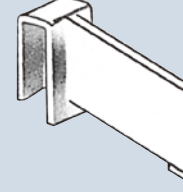
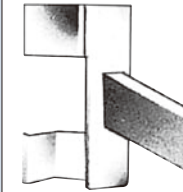
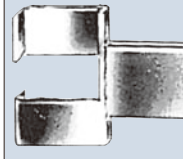
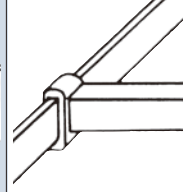
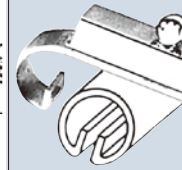
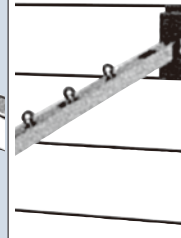
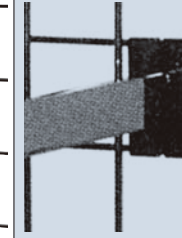

Chrome

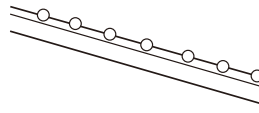
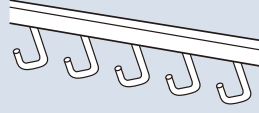
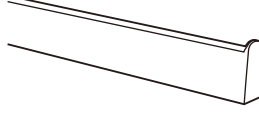
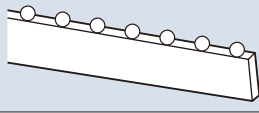
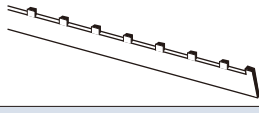
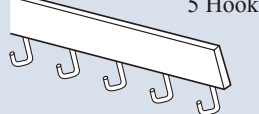
Select Face Out Below And Match With Proper Bracket At Right	 Wall	 Standards ½" Slots On 1" Center	 H/D Standards 1" Slots On 2" Center	 Horizontal 1" Sq Tube	 Horizontal ½" × ½" Rect Tube	 Vertical 1" SQ Tube	 Vertical ⅝" × 1⅝" Rect Tube	 1" × ⅜" Crossbar	 " J " Rail	 Slatwall	 Gridwall
Straight Face Out ¾" Sq. Tube, 12"L 	TB12	TS12	TR12	TH12		TV12 -12" TV16 -16"		WR12 -12" WR16 -16"		SW12	GW12
Waterfall ¾" Sq. Tube, 18"L, 7 Balls 	BW7B	BS7B	TR7B	BH7B		BV7B		WR7B	TJ7B	SW6B 16" 6 Balls	GW7B
Hook Waterfall ¾" Sq. Tube, 18"L, 5 Hooks 	HW5H	HS5H	TR5H	HH5H		HV5H		WR5H	TJ5H	SW5H 16" 5 Hooks	GW5H
Straight Face Out 1½" × ½" Rect Tube, 12"L 	RB12	RS12	RR12		RH12S	TV12R -12" TV16R -16"	RV16 -16" RV22 -22"			RW12	RG12
Waterfall 1½" × ½" Rect Tube 17"L, 7 Balls 	RB7B	RS7B	RR7B		RH7B					RW7B	RG7B
Waterfall 1½" × ½" Rect Tube 17"L, 8 Cubes 	RB8C	RS8C	RR8C		RH8C					RW7C 15" 7 Cubes	RG8C
Hook Waterfall 1½" × ½" Rect Tube 17"L, 5 Hooks 	RB5H	RS5H	RR5H		RH5H					RW5H	RG5H



Headquarter / Warehouse

1030 E. Valencia Dr., Fullerton, CA 92831, U.S.A.

Tel: (714) 578-9100 Fax: (714) 578-9111

E-mail: sales@displaysbyjack.com

www.displaysbyjack.com